

The Project Gutenberg eBook of Fall and Holiday Trade, Season 1900-1901, Nerlich & Co. Illustrated Catalogue, by Nerlich & Co.

This ebook is for the use of anyone anywhere in the United States and most other parts of the world at no cost and with almost no restrictions whatsoever. You may copy it, give it away or re-use it under the terms of the Project Gutenberg License included with this ebook or online at www.gutenberg.org. If you are not located in the United States, you'll have to check the laws of the country where you are located before using this eBook.

Title: Fall and Holiday Trade, Season 1900-1901, Nerlich & Co. Illustrated Catalogue

Author: Nerlich & Co.

Release date: March 30, 2015 [EBook #48611]

Language: English

Credits: Produced by Richard Tonsing, Chris Curnow and the Online Distributed Proofreading Team at <http://www.pgdp.net> (This file was produced from images generously made available by The Internet Archive)

*** START OF THE PROJECT GUTENBERG EBOOK FALL AND HOLIDAY TRADE, SEASON 1900-1901, NERLICH & CO. ILLUSTRATED CATALOGUE ***

**Printed Muslin
Flags**

ALL SIZES—ON STICKS

NUMBER. SIZE IN INCHES.	2	3	4	5	5½	6	7	8	NET.
	2½ × 4	4 × 6	4½ × 7	6 × 9	7½ × 10	9 × 14	12 × 18	18 × 27	
UNION JACK	\$0.55	\$0.80	\$0.90	\$1.70	\$2.10	\$3.25			gross
MERCHANTS (Red Ensign)								\$9.25	"
CANADIAN " "				1.70		3.25	\$5.40		"
STARS AND STRIPES				1.50		3.00	4.20	9.60	"

**Printed
Cotton Flags**

IN UNION JACKS OR
CANADIAN
ENSIGNS

(Specify whether
Union Jack or
Canadian Flag
wanted)

No.	SIZE.	NET.
21	2 × 3 inches, unmounted per gross	\$.40
22	2½ × 3½ " on sticks "	.60
23	4 × 6 " " "	.90
24	4½ × 7 " " "	1.20
25	6 × 9 " " "	1.90
25½	7 × 11 " " "	2.40
26	8 × 14½ " " "	3.60
27	12 × 18 " " "	5.75
27½	13½ × 20 " " "	7.80

We draw special attention to the Canadian Flag in the above quality. It is with Coat of Arms in correct colors and far surpasses any other line at similar prices.

**Hemmed
Cotton Flags**

(NOT ON STICKS)
FINE QUALITY—
ENGLISH MAKE

		NET.
Union Jacks	15 × 10 inches	per dozen \$.40
" "	17 × 15	" " .65
" "	30 × 17	" " 1.20
" "	25 × 21	" " 1.00
" "	35 × 24	" " 1.55
Red Ensign	30 × 17	" " 1.20
" "	35 × 24	" " 1.55
" "	60 × 30	" " 6.00
" "	70 × 40	" " 8.00
White "	35 × 24	" " 1.55
Canadian	15 × 10	" " .40
" "	30 × 17	" " 1.20
" "	35 × 22	" " 1.55
Royal Standard	15 × 10	" " .40
" "	25 × 22	" " 1.00
" "	35 × 24	" " 1.55
Scotch "	30 × 24	" " 1.35
Irish "	30 × 24	" " 1.35
Union Jacks with Soldier designs in centre, No. F. 1, size 15 × 10 inches		" " .42
Union Jacks with pictures of Generals in centre, assorted, size 30 × 30 inches		" " 2.00
Stars and Stripes, size 34 × 24 inches		" " 1.20
	36 inches long, round shape per dozen	.25

FLAG STICKS



48 " " " " "

.30

**Fine Silk
Flags**

		NET.
Union Jack	2 × 2¾ inches	per dozen .20
" "	6 × 8½ "	" .80
" "	8½ × 12 "	" 1.25
" "	10½ × 11½ "	" 3.00
" "	16 × 23 "	" 5.50
Dominion Ensign	× 18 "	" 3.75

Headquarters for Flags



NERLICH & CO.

35 Front St. West, TORONTO

PRICES

October 20th, 1900



UR Soldier Boys arrive from South Africa in a few days and the demonstrations on their return promise to excel all previous outbursts of enthusiasm. Have you stock of Flags to meet the big demand?



Nerlich & Co.

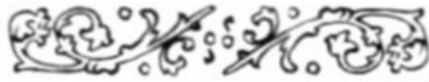

FALL AND HOLIDAY TRADE

SEASON 1900-1901

NERLICH & CO.

ILLUSTRATED CATALOGUE

FANCY GOODS

Toys, Dolls, Games, Novelties

Fancy China and Glassware

Toilet Sundries



NERLICH & CO.

35 FRONT ST. WEST

TORONTO

Table of Contents

[TO THE TRADE.](#)

[INDEX.](#)

[IMPERIAL SYMPHONIONS.](#)

[REMOVAL NOTICE.](#)

[TRANSCRIBER'S NOTES.](#)

TO THE TRADE.



SEASON 1900-1901.

We take pleasure in submitting herewith our **Fall and Holiday Trade Catalogue** for the Season of 1900-1901. In compiling this list we have endeavored to include as large a portion of our immense range as possible, and have spared neither time or expense in faithfully illustrating and describing each article.

Not only is it our aim to have our Catalogue of greatest possible assistance to our patrons in ordering goods, but it is gotten up subject to trade discount, so that he in turn may use it in making sales to his customers of goods he does not carry in stock.

When ordering give name, number and price, or fully describe articles required if not found in this list.

If you are not known to us, please give names of Toronto houses with whom you do business as reference; or if ordering goods C.O.D. kindly remit with order sufficient to cover express charges both ways, which amount will be deducted from your bill.

For **Trade Discounts and Terms** we refer you to colored slip on foregoing page.

Trusting to be favored with your orders, we remain,

Respectfully yours,

NERLICH & CO.

ALBUMS.

NOTE.—All our Albums above \$20.00 dozen list are made to accommodate either cabinets or the newer 5 × 7 size pictures.



No. 173/68.



No. 173/74.



No. 45/34A.

173/67. Shaded Celluloid,

173/68. White Celluloid,

173/74. Shaded Celluloid,

173/75. Shaded Celluloid,

45/33. White Celluloid,

Dozen.

embossed front decoration, plush binding and corner tips, nickel clasp, gilt edges; has spaces for 16 cabinets and 4 cards; size, 8½ × 6¾ inches \$ 7 50

otherwise same as 173/67 \$ 7 50

front embossed in gold and colors, plush binding and corner tips, nickel clasp; has spaces for 18 cabinets and 4 cards; size, 10 × 8 inches \$13 00

similar to 173/74 \$13 00

colored flower front decoration, plush binding and corner tips, nickel clasp; \$16 00

173/86. Shaded Celluloid,

spaces for 18 cabinets
and 8 cards
assorted colors fine
embossed front design,
plush binding and
corners, nickel clasps; \$17 50
has spaces for 20
cabinets and 16 cards;
size, 10½ × 9 inches

45/34 A&B. Assorted Celluloid,

handsome front
designs, plush binding
and corners, have
spaces for 20 cabinets \$19 20
and 16 cards; size
11 × 9 inches

298/77. Shaded Celluloid,

assorted colors,
handsome embossed
front, plush back,
extension clasp; spaces \$22 80
for 20 cabinet or new
5 × 7 size photos and
16 cards; size,
10½ × 8½ inches



No. 298/79.



No. 298/75.



No. 298/58.

298/79. Blue Wedgwood Celluloid,

298/75. Plush,

298/58. Dark Leather,

cupids and scroll frame
embossed in white,
plush back cover,
nickel clasp; spaces for \$30 00
24 cabinet or new
5 x 7 photos and 16
cards
assorted colors, brass
shield centre and
corner ornaments, gilt
clasp; has spaces for \$27 00
24 cabinet or new size
5 x 7 pictures and 16
cards
embossed front,
lithographed interior
decoration, gilt clasp;
spaces for 24 cabinet \$30 00
or new size 5 x 7
pictures and 16 cards
embossed front,

298/61. Fine Leather,

lithographed interior decoration, gilt clasp, genuine gold edges; spaces for 22 cabinets or new size 5 x 7 pictures and 16 cards embossed front, lithographed interior decoration, gilt clasp, genuine gold edges; spaces for 28 cabinet or new size 5 x 7 pictures and 16 cards \$43 20 \$50 00

298/63. Morocco Leather,

TOILET CASES.

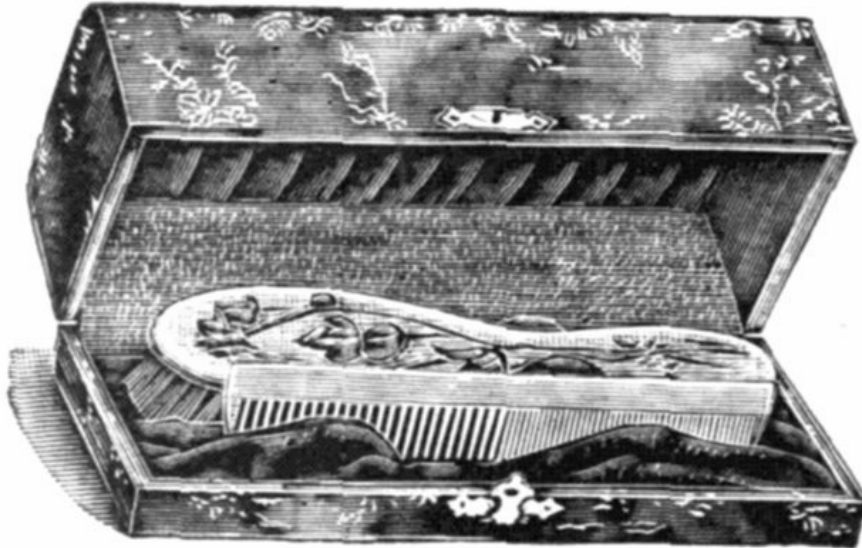

400.

Fancy paperette covered, crepe lining, fitted with white comb and brush. Size, 8 x 3 3/8 inches Dozen, \$12 00

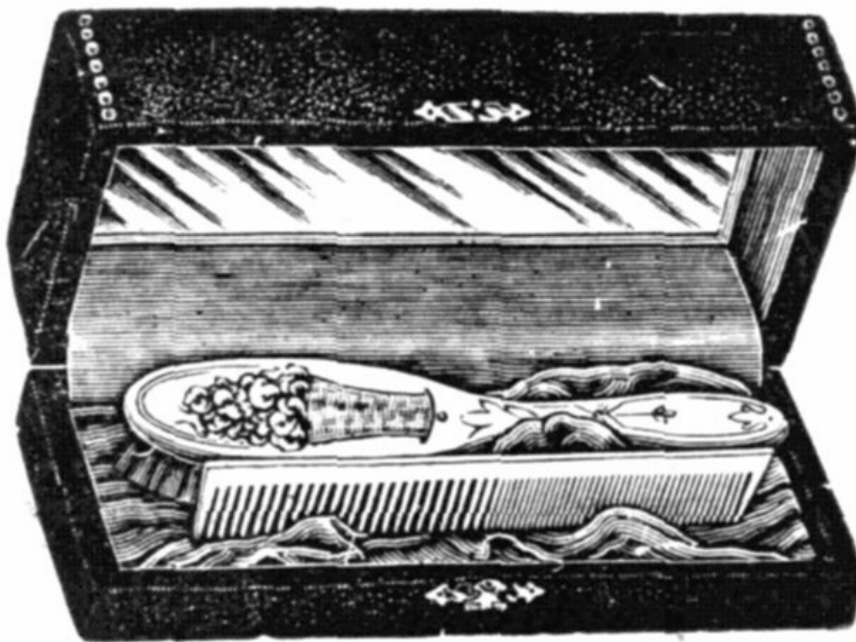

Fancy paperette, with embossed and painted celluloid top, crepe lined;

401.

fitted with white Dozen, \$16 00
comb, brush
and full
stationary
mirror in lid.
Size,
8 × 3³/₈ × 2¹/₂
inches

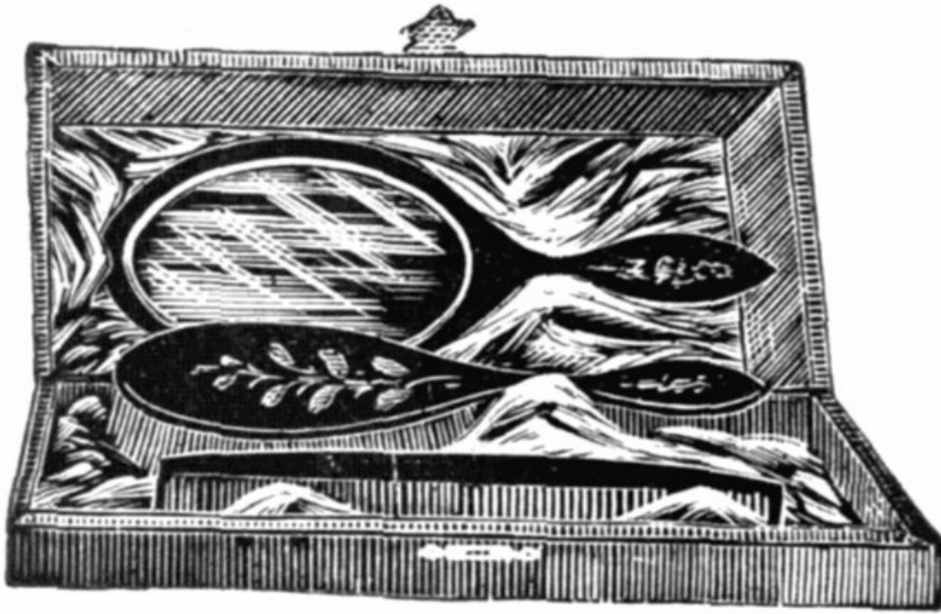

Lithographed
celluloid top,
fancy paperette
body, crepe
lined; fitted
with white
comb, brush
and bevelled
mirror. Size,
8¹/₂ × 3³/₄ × 2¹/₂
inches

Dozen, \$20 40

402.



Full celluloid,
tinted in two
shades, top
embossed fancy
design and
spray of flowers
in natural
colors, crepe
lined; fitted
with white
comb, brush
and mirror.
Size, 8¹/₂ × 4
inches

Dozen, \$22 80

300.



301.

Full celluloid,
top embossed
spray of flowers
and fancy
designs, crepe
lined; fitted
with white
comb, brush
and mirror.
Size, 10 × 5¼
inches

Dozen, \$26 40



403.

Combination
Toilet and
Manicure Set.
Fancy
paperette,
crepe lined;
fitted with white
comb, brush,
bevelled mirror,
and three
pieces manicure
fittings. Size,
9½ × 5¼ × 2½
inches

Dozen, \$27 60



404.

Upright shape.
Toilet and
Manicure
combination.
Fancy
paperette, fitted
with white
comb, brush, Dozen, \$32 00
bevelled mirror,
and three
pieces manicure
fittings. Size,
 $9\frac{3}{8} \times 3\frac{1}{4} \times 6$
inches



302.

Full gold
celluloid, ivy
leaves under
transparent, top
embossed frame
and
lithographed Dozen, \$32 00
heads, satin
lined; fitted
comb, brush
and bevelled
mirror. Size,
 $8\frac{1}{2} \times 4$ inches



303.

Full dark
celluloid, fancy
shape, top and
front
lithographed
ideal figures
and flowers,
satin lined;
fitted white
comb, brush
and bevelled
mirror. Size,
 $8\frac{1}{2} \times 4$ inches

Dozen, \$33 60



304.

Full celluloid,
extension base,
top tinted in
two shades with
flowers blank
and in natural
colors, satin
lined; fitted
comb, brush
and bevelled
mirror. Size,
 $11 \times 5\frac{1}{2}$ inches

Dozen, \$33 60



Above cut should show extension base, and not manicure fittings.

305.

Full rosewood
celluloid, top
with
lithographed
flowers and
landscape,
extension base,
satin lined; Dozen, \$43 60
fitted with
decorated
comb, brush
and mirror.
Size, 11 × 5½
inches



Full celluloid,
tinted,
embossed bands
and sprays of
flowers in
corners in
natural colors,

306.

extension base,
embossed, satin
lined; fitted
with comb,
brush, mirror
and three
pieces,
manicure
fittings. Size,
10¾ × 6½
inches,
Dozen, \$43 20

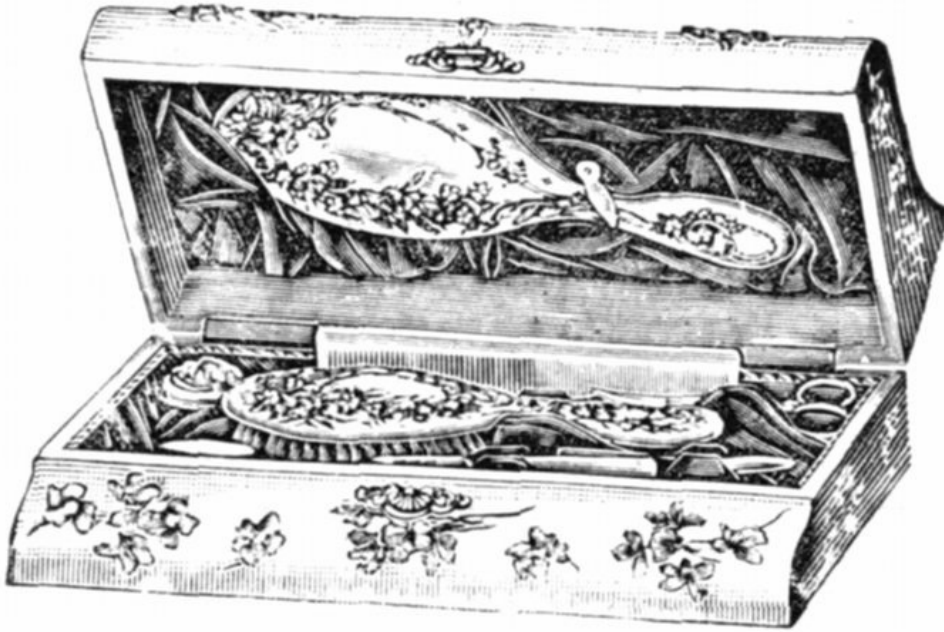

307.

Full royal blue
celluloid, top
embossed
flowers,
medallion head
and gilt frame,
front embossed
flowers, satin
lined; fitted
with decorated
comb, brush,
mirror and four
pieces,
manicure
fittings. Size,
9½ × 5 inches
Dozen, \$48 00



308.

Full rosewood
celluloid, cream
color panels,
lithographed
flowers, band
and beautiful
ideal head, satin
lined; fitted
with decorated
comb, brush,
mirror and
three pieces,
manicure
fittings. Size,
11 x 6 inches
Dozen, \$54 00



309.

Full rosewood celluloid, extension base, top with gold panel, lithographed flowers and beautiful ideal head, satin lined; fitted with decorated comb, brush, mirror and three pieces manicure fittings. Size, 11 x 6¼ inches Dozen, \$60 00



310.

Full celluloid, violets and other flowers under transparent, embossed fancy frame and lithographed ideal figures, satin lined; fitted with decorated comb, brush and mirror. Size, 9¾ x 6½ inches Dozen, \$66 00



No. 311.

405.

Upright, automatic. Full celluloid, fancy lithographed pattern, with lithograph picture on top and two framed medallions on front, satin lined; fitted with comb, brush, mirror, and three manicure fittings. Size, $10\frac{1}{4} \times 7 \times 3\frac{5}{8}$ inches

Dozen, \$66 00

311.

Full celluloid, automatic, top and front embossed with sprays of flowers in colors, satin lined; fitted with white comb, brush, mirror, and four pieces manicure fittings. Size, $9\frac{1}{2} \times 4\frac{3}{4} \times 5\frac{3}{4}$ inches.

Dozen, \$72 00



Full fancy celluloid, green, gold and violets, under

312.

transparent,
fancy frame
with
lithographed
centre, satin
lined; fitted
with decorated
comb, brush,
mirror, and four
pieces manicure
fittings. Size,
11½ × 6 inches

Dozen, \$90 00



313.

Full dark
celluloid with
violets and
other flowers
under
transparent top,
embossed frame
and
lithographed
ideal head;
drawer in base; Dozen, \$102
00
satin lined;
fitted with
decorated
comb, brush,
mirror and four
pieces manicure
fittings. Size,
11½ × 6½ × 5½
inches



314.

Full celluloid,
automatic, top
and front with
gold panels,
lithographed
ideal figures,
flowers and
fancy designs,
satin lined;
fitted with
decorated
comb, brush,
mirror, and five
manicure
fittings. Size,
 $9\frac{3}{4} \times 4\frac{3}{4} \times 6$
inches

Dozen, \$102
00



315.

Full dark
celluloid,
automatic,
raised top and
drop front.
Violets and gold
under
transparent;
front embossed
fancy design,
cupid frame,
lithographed
ideal head,
landscape and
flowers; satin
lined; fitted
decorated
comb, brush
and mirror and
six pieces
manicure
fittings. Size,
 $11 \times 5\frac{3}{4} \times 7\frac{3}{4}$
inches

Each, \$10 00



316.

Full rosewood
celluloid,
automatic,
raised top and
drop front.
Fancy celluloid
front with
violets and gold
under
transparent, top
lithographed
flowers and
beautiful ideal
head; satin
lined; bevel
mirror in back;
fitted with
comb, brush,
mirror and six
pieces manicure
fittings. Size,
11 × 6¾ × 7½
inches

Each, \$11 00

BRUSH SETS

In Fancy Boxes.



No. 256/87.

256/82.

Black paper covered box, silk lined. With 7 row **Imitation Ebony** Hair brush, cloth brush, hat brush and comb

Per set, \$3 00

256/84.

Leatherette covered box, plush lined. With 15 row **White Enamelled** Hair brush, bevelled mirror and comb.

Per set, \$3 80

256/85.

Leatherette covered box, with lock and key, plush lined. With two 12 row **White Enamelled** Hair brushes, bevelled mirror and comb

Per set, \$4 50

256/83.

Leatherette covered box, silk lined. With 12 row **Imitation Ebony** Hair brush, cloth brush and hair brush.

Per set, \$5 00

256/87.

Leatherette covered box, plush lined. With **Imitation Ebony** 13 row Hair brush, cloth brush, hat brush, bevel mirror and comb

Per set, \$4 50

Same as 256/87 but set is in

Per

CUTS FOR SALE. We will supply to our customers, **AT COST**, duplicate electrotypes of any cuts in this Catalogue. In lots of ten or over cost averages from 30 to 40 cents each according to size.

Allow about three days for having the electrotypes made, and in ordering give number of cut and Catalogue page it appears on.

TOILET SETS.



1359.

Embossed white
metal
mountings and
backs, oval
bevelled plate
mirror, 11 row
white bristle
brush and 7
inch white
celluloid comb

Per
set, \$2 40

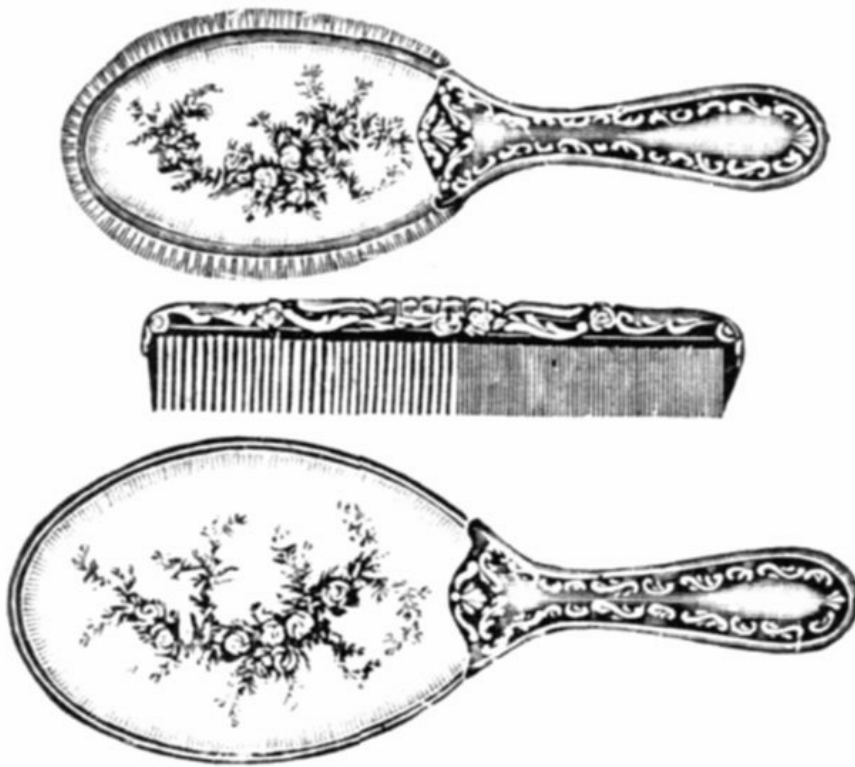

6000.

Aluminum embossed and polished mountings, porcelain centres with "Buttercup" flower decorations, oval bevelled plate mirror, 11 row white bristle brush, 7 inch celluloid comb.

Per set, \$3 50

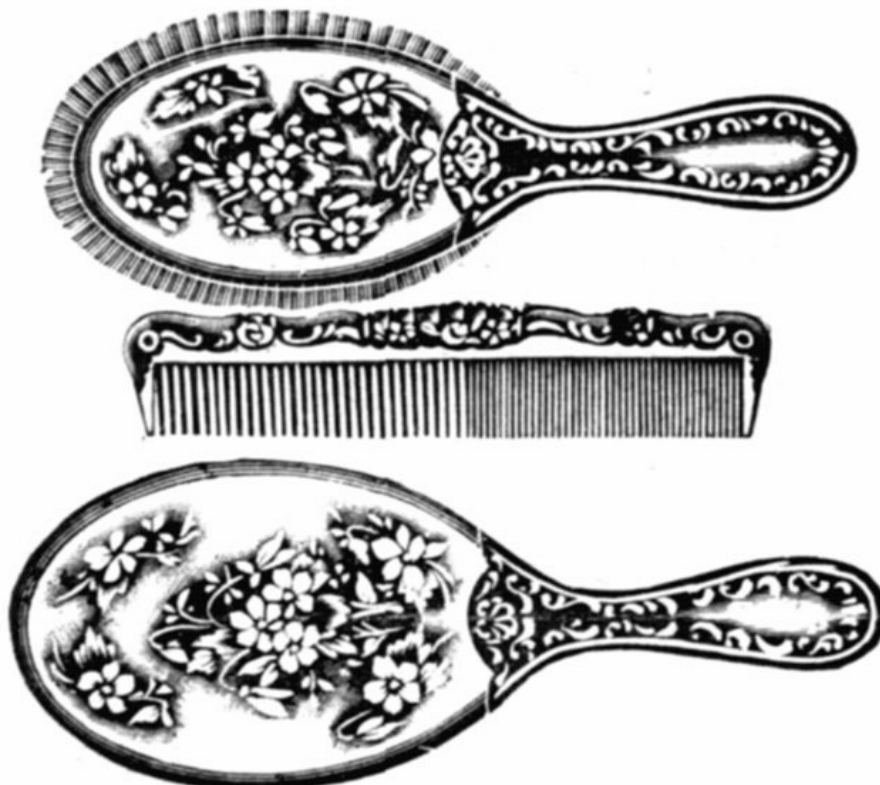

Satin gilt embossed metal mountings, porcelain

6001.

centres with
"Violet" flower
decoration; fine
bevelled plate
mirror, 11 row
white bristle
brush, 7 inch
imitation
tortoise shell
comb

Per
set, \$4 20



6006.

Bright silver
finished
mountings, with
handsomely
embossed metal
centres; fine
oval bevelled
plate mirror,
good quality 13
row white
bristle brush
and 7 inch
imitation
tortoise shell
comb.

Per
set, \$4 30

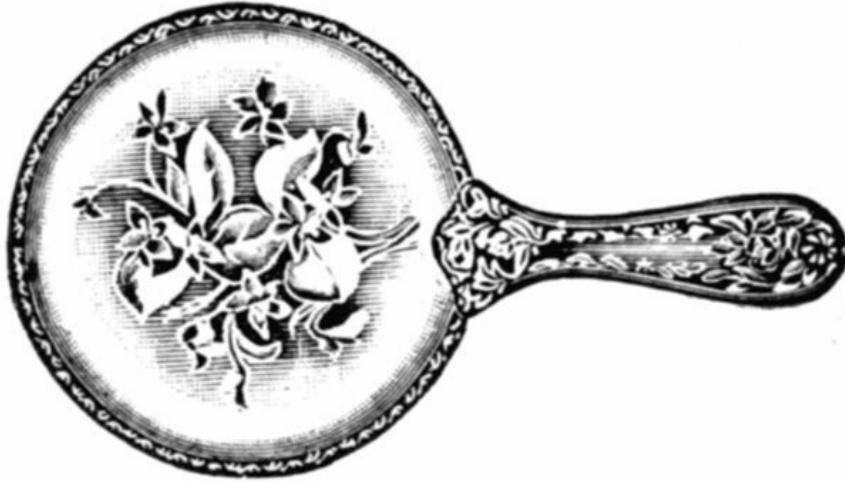

No. 6103.

6103.

Handsomely embossed silver plated mountings, porcelain centres with "Violet" flower decoration; fine bevelled plate 5 inch round mirror, 11 row white bristle brush and 7 inch imitation tortoise shell comb

Per set, \$5 20

6007.

Handsomely embossed silver plated mountings and centres; fine bevelled plate 5 inch round mirror, 11 row white bristle brush and 7 inch imitation tortoise shell comb

Per set, \$5 20

For other Combs, Brushes and Mirrors, see under "Toilet Sundries" in index.



6008.

Satin gilt
finished
mountings, with
handsomely
embossed and
burnished
centres. Fine
bevelled plate
5 $\frac{1}{8}$ inch mirror,
good quality 13
row white
bristle brush
and 7 inch
imitation
tortoise shell
comb

Per
set, \$6 00



6009.

German silver metal, silver plated, embossed mountings. Blue Wedgwood centres. Fine 5 1/8 inch round bevelled plate mirror, extra fine 13 row celluloid face white bristle brush and 7 inch tortoise shell comb

Per set, \$8 50

MIRROR, Separate.

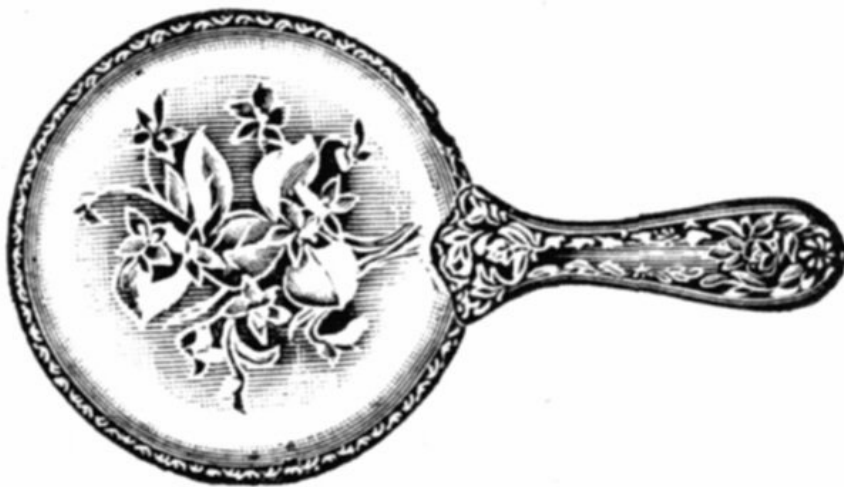

6010.

Embossed silver plated mounting. "Violet" decorated porcelain centres. Fine 5 1/8 inch

Per dozen, \$31 20

bevelled round
plate mirror

SHAVING CASES.

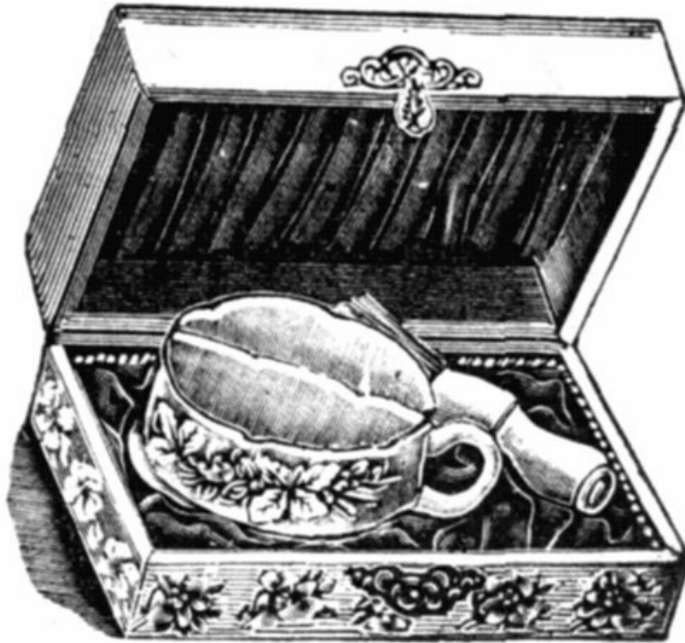

No. 325.

406.

Fancy paperette covered, crepe lined; fitted with shaving brush and mug. Dozen, \$13 00
Size, $5\frac{3}{4} \times 5\frac{1}{2} \times 3\frac{1}{4}$ inches

407.

Fancy paperette with embossed celluloid band, crepe lined; fitted with shaving brush and mug. Dozen, \$16 80
Size, $7\frac{1}{2} \times 5\frac{1}{2} \times 3\frac{1}{2}$ inches

325.

Full celluloid, embossed with scroll design and large rose in natural colors; fitted with mug and brush. Dozen, \$24 00
Size, $7\frac{1}{2} \times 5$ inches

326.

Full celluloid, fancy front design, top with violets in natural colors; satin lined; fitted mug and brush. Dozen, \$33 60
Size, $7\frac{1}{2} \times 5$ inches



No. 327.

327.

Full tinted celluloid, embossed flowers in natural colors; satin lined; fitted with mug and brush and block for razor. Size, 8 x 7½ inches

Dozen, \$42 00

328.

Full rosewood celluloid, drawer in base. Top gilt panel, lithographed flowers and ideal head; satin lined; fitted with mug, brush, removable mirror and black for razor. Size, 5¼ x 7½ inches

Dozen, \$60 00

Glove and Handkerchief Sets.



143/100.

Leatherette, padded, top embossed flowers in natural colors, paper lined. Dozen sets, \$7 20

Size, glove, 12 x 3½ inches; handkerchief, 6¼ x 6¼ inches

14/534.

Enamel painted wood, fancy lithographed top, paper lined. Doz. sets, \$8 00

Size, glove, 12 x 3¾ in.; hkf., 6 x 6 in.

237/283.

White celluloid, lithographed top, gilt metal corner ornaments, half sateen lined, padded interior. Doz. sets, \$16 80

Size, glove, 12 x 3½ in.; hkf., 6¼ x 6¼ in.

410.

Fancy paperette covered on wood body, lithographed celluloid top, satin lined. Size, Dozen sets, \$24 00

glove, 12½ x 3½ inches; hkf., 7 x 6 inches



No. 340.

340.

Full celluloid, front embossed fancy design, top with large spray of flowers in natural colors, sateen lined. Size, glove, 12 x 3 in.; hkf., 5½ x 5½.

Doz. sets, \$33 60

341.

Rosewood celluloid, front embossed fancy design, top with lithographed flowers and centre panel, ideal head; satin lined. Size, glove, 12 x 3¾ in.; hkf., 6 x 6 in.

Dozen sets, \$60 00



342.

Rosewood
celluloid, front
embossed fancy
design, top with
lithographed
flowers and
beautifully
lithographed
ideal head, satin
lined; furnished
with stretcher.
Size, glove,
13¾ × 4¾ in.;
handkerchief,
7½ × 7½.

Dozen
sets, \$78 00

GLOVE BOX separately:

14/693.

Enamel painted
wood box, fancy
lithographed
top, paper lined; Dozen, \$4 00
lock and key.
Size, 12 × 3
inches

NECKTIE BOXES.



No. 346.

345.

Full celluloid, top with spray of flowers in natural colors, sateen lined. Size, 12 × 3½ inches

Dozen, \$16 80

346.

Full celluloid, top and front embossed with sprays of flowers and fancy word "Neckties" and flowers in natural colors; full satin lined. Size, 13½ × 4½ inches

Dozen, \$33 60



347.

Full rosewood celluloid, front embossed fancy design, top with lithographed flowers and ideal figures. Size, 13½ × 4½ inches

Dozen, \$38 40

COLLAR AND CUFF BOXES.

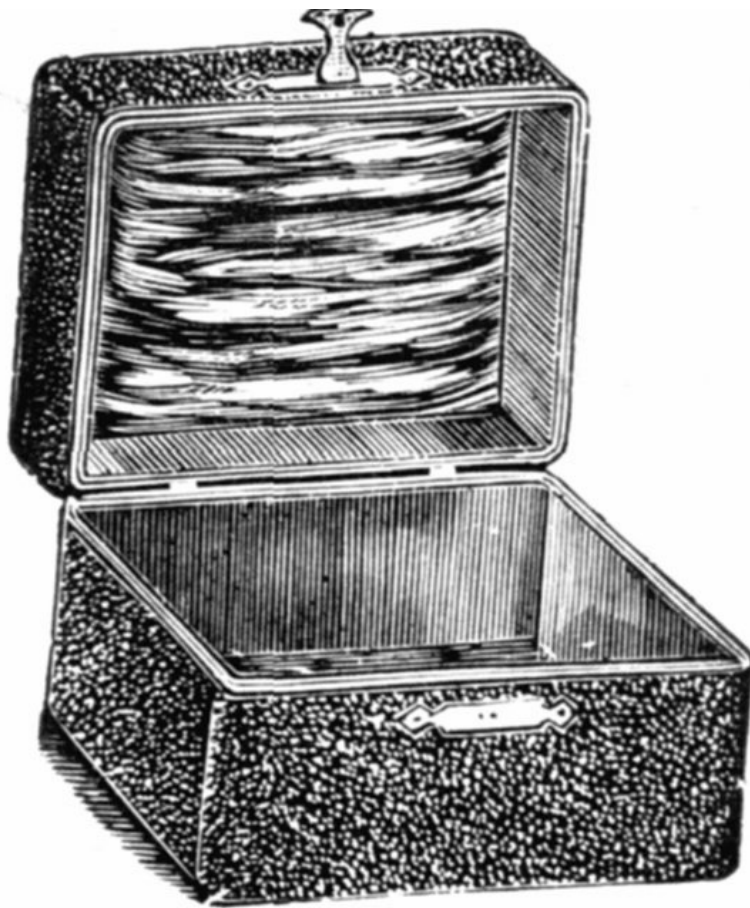

408.

Similar to cut.
Fancy flowered
paperette, half
crepe lined. Dozen, \$8 00
Size,
 $5\frac{1}{2} \times 5\frac{3}{4} \times 5\frac{3}{4}$
inches



409.

Combination.
Lithographed
celluloid top,
fancy flowered
paperette sides; Dozen, \$15 00
half satin lined.
Size,
 $5\frac{1}{4} \times 5\frac{3}{4} \times 5\frac{3}{4}$
inches

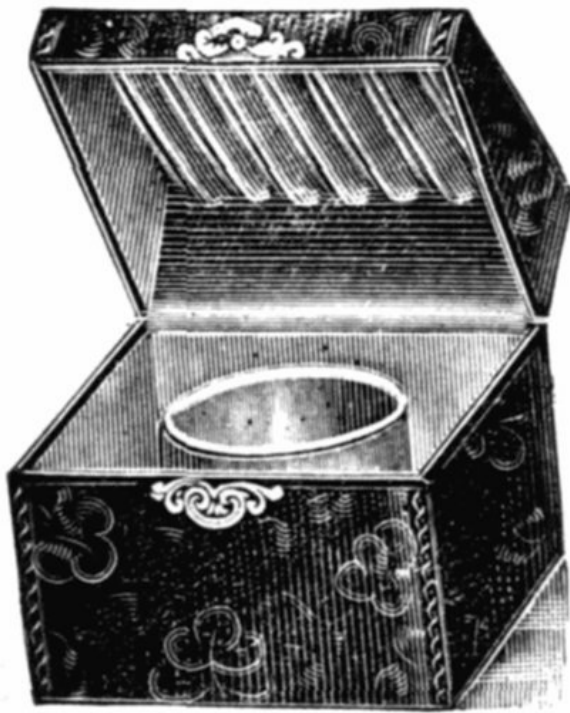

350.

Combination.
 Full rosewood
 celluloid, dark
 background
 with flowers
 under
 transparent,
 embossed frame Dozen, \$24 00
 and colored
 photograph
 centre; full satin
 lined. Size,
 6 x 6 x 5¼
 inches



351.

Combination.
 Full celluloid,
 tinted and
 colored tracing;
 front embossed
 with flowers
 and words
 "Collars and Dozen, \$33 60
 Cuffs"; top with
 roses in natural
 colors; half
 satin lined. Size,

6½ × 6½ × 6
inches



352.

Combination.
Round shape,
dark celluloid
with violets and
gold
transparency;
top panel with
lithographed
head and
flowers, gold
panel; full satin
lined. Size,
6½ × 6½ × 5¾
inches

Dozen, \$39 60



Combination.
Fancy shape,

353.

fancy celluloid,
sprays of
violets, etc,
under
transparent; top Dozen, \$48 00
with
lithographed
ideal figures in
frame; satin
lined. Size,
8 × 7½ × 5¾
inches

PHOTO. FRAMES.

PAPER EMBOSSED.

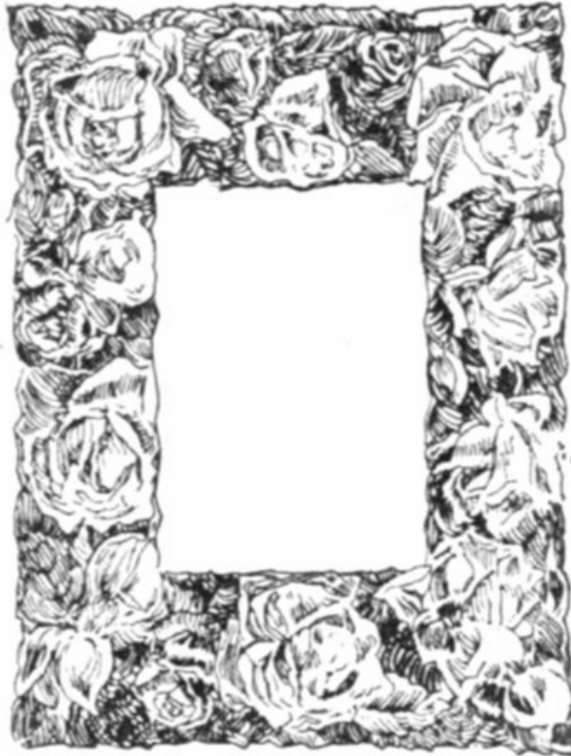

379/6.

"Rose embossed,"
similar to cut, light
ground, with heavy
embossed sprays of
roses and buds, glass \$ 1 60
front, easel or hanger
back, extra good value;
1 dozen in package

CELLULOID.



500/167.

Embossed flower
decoration in water
colors, gilt decorated
turn over pieces as in
cut, glass front, easel
back \$ 2 50

136/1109.

As cut, white celluloid,
fancy embossed and
tinted pattern, glass
front, easel back \$ 3 60

136/1114.

White celluloid,
silvered chain pattern
and silver decorated
turn over pieces, glass
front, easel back \$ 4 00

136/1116.

As 136/1114, but is
silvered flower design \$ 4 00

ALUMINUM.



No. 241.

As cut, silver satin

241.

finish, turn over
centre, cord edge,
maple leaves on
corners; easel back

\$ 3 00

GLASS EASEL.

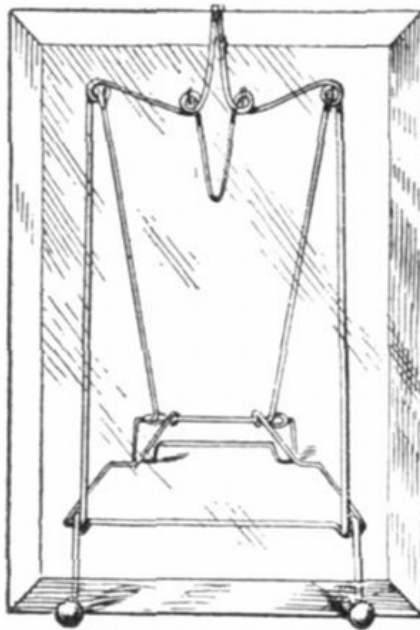

136/1243.

As cut. Bevel glass,
with brass wire easel;
size 5½ × 7½ for new
large size photos

\$ 4 00

FANCY WOOD RIM.



No. 143/111.

143/109.

Similar to cut 143/111.
Glazed paper inner
frame, flowers under
glass, leatherette
covered wood outer
frame; easel back;
cabinet size

\$ 7 20

143/110.

Same as 143/109, but
takes new 5 × 7 photos

\$ 8 40

143/111.

As cut. Glazed paper,
varnish finish, dark
green color ground,
sprays of clover; easel
back; cabinet size

\$ 8 00

METAL.

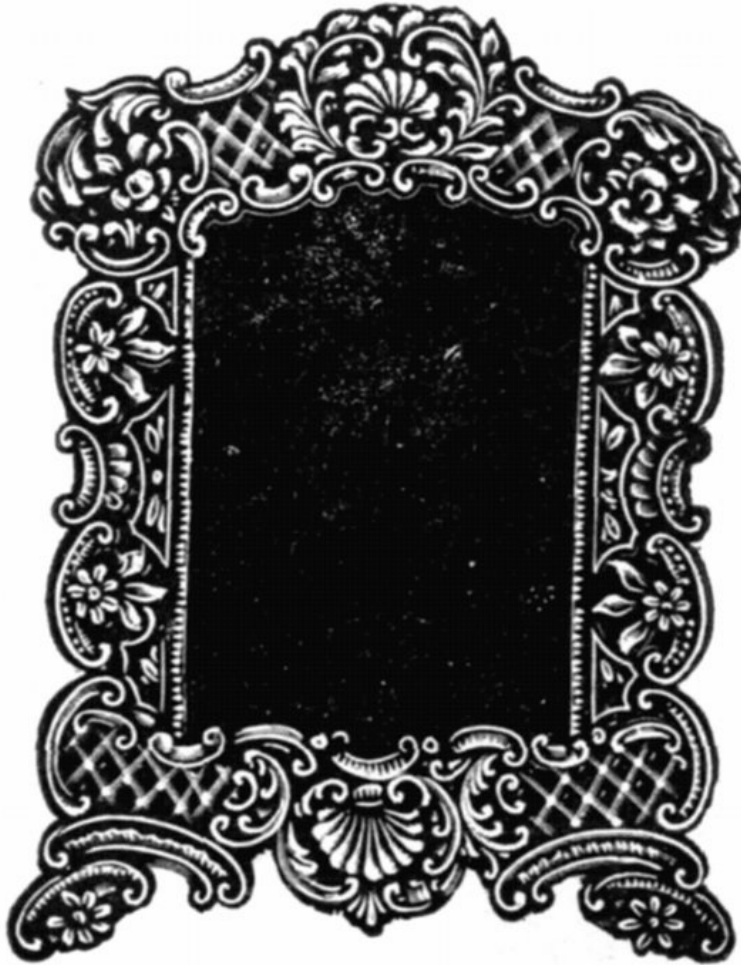

No. 620 & 620x.

620x.

Oxidized metal frame
as cut, cabinet size,
glass front, metal easel \$ 5 50
back

620.

Gilt metal frame as cut,
cabinet size, glass \$ 8 40
front, metal easel back

**PHOTO. FRAMES.
ALL WITH GLASS FRONTS AND EASEL BACKS.**

GILT METAL.



No. 6016.



No. 6017.

6014.

6015.

6016.

6017.

6018.

Dozen.

Oval miniature, plain rim with scroll pattern border, dust-proof back, satin gilt finish. Size, $2\frac{7}{8} \times 2$ inches \$ 6 00

Round miniature, plain rim with fine chain border and neat ornament top, satin gilt finish. Size, $2\frac{1}{4}$ inch opening \$ 6 50

Card de visit size miniature, $3\frac{1}{2} \times 2\frac{3}{4}$ inches, embossed rim with scroll border, satin gilt finish \$ 6 50

Round shape, 4 inches in diameter, fine embossed rim with neat rope pattern border, satin gilt finish \$ 7 50

Oval shape, cabinet size, fine embossed rim with neat rope pattern border, satin gilt finish \$ 7 50



No. 6019.

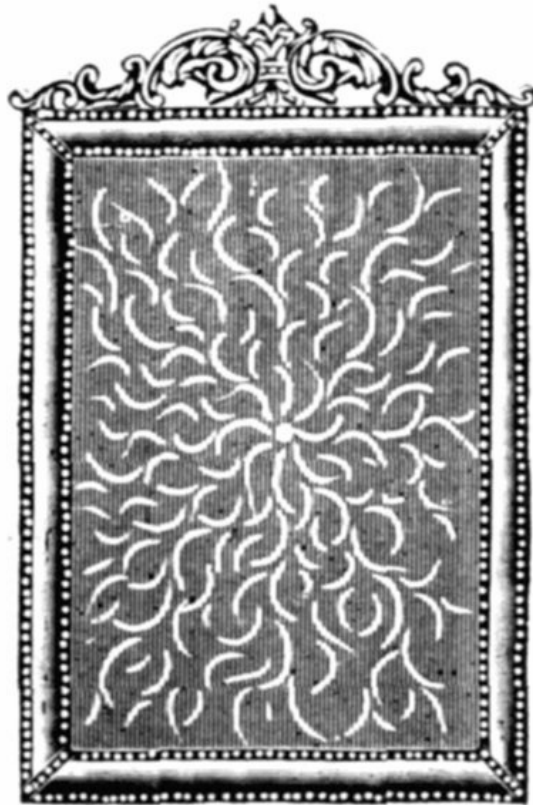

No. 6020.

6019.

6020.

Dozen.

As cut. Cabinet size,
fine embossed rim with
neat ornament corners, \$ 8 00
satin gilt finish

As cut. Cabinet size,
fine beaded rim, with
neat ornament top, \$ 8 00
satin gilt finish



No. 6021 and 6023, Minerva.

6021.

6022.

6023.

Dozen.

As cut. Minerva size,
 (5½ × 7 inches) fine
 perforated rim with neat ornament corners,
 burnished gilt finish \$13 00
 Minerva size (5 × 7½
 inches) handsomely
 embossed burnished \$16 00
 gilt rim
 Minerva size (5 × 7½
 inches) very fine
 embossed and \$20 40
 perforated rim with
 neat ornament corners,
 burnished gilt finish

SOLID BRASS.

Very finely burnished and will retain color and lustre for a lifetime.

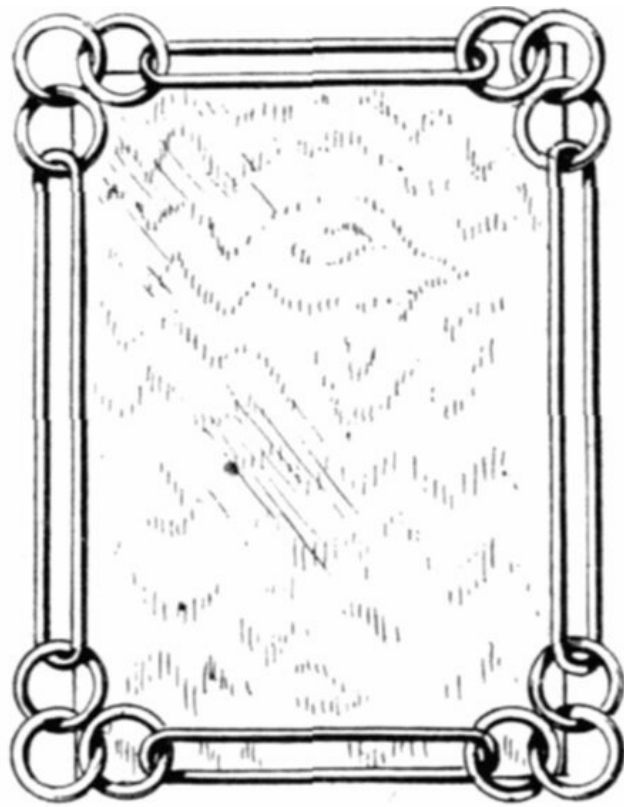

No. 301/304.

301/300.

301/302.

301/303.

301/304.

301/305.

Dozen.

Cabinet size; chain pattern	\$24 00
Cabinet size; solid rim, chain border	\$30 00
Cabinet size; solid inner rim, wide scroll pattern	\$42 00
As cut. Minerva size (5 × 7 inches) fancy link design	\$42 00
As 301/304 but "Maple" size, having picture opening, 6½ × 8½ inches	\$66 00

WORK BOXES.

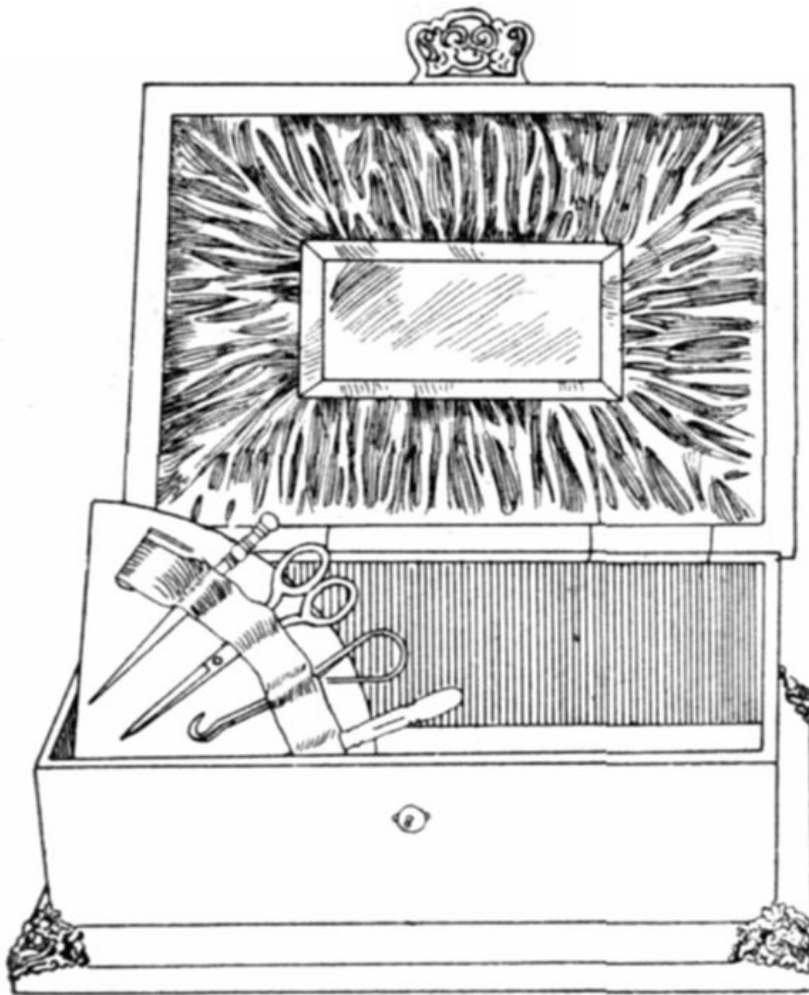

No. 237/224.

	Dozen.
237/278.	White Celluloid, lithographed top, 3 pieces fittings. Size, $3\frac{1}{2} \times 2\frac{3}{4} \times 1\frac{1}{2}$ inches \$ 1 80
237/279.	As 237/278 but size $4\frac{1}{2} \times 3\frac{3}{4} \times 1\frac{3}{4}$ inches \$ 3 00
237/280.	White Celluloid, fine lithographed top, gilt metal corners, mirror inside lid, half sateen lined, 4 pieces fittings. Size, $5\frac{1}{2} \times 4 \times 2\frac{1}{4}$ inches \$ 4 00
237/221.	White Celluloid, lithographed top with plush border, gilt metal corner ornaments, mirror in lid, sateen lined; fitted with 5 articles. Size, $6\frac{1}{2} \times 4\frac{1}{2} \times 2\frac{1}{2}$ inches \$ 8 00
237/222.	White Celluloid, embossed top, gilt metal centre and corners, mirror in lid, sateen lined; fitted 5 pieces. Size, $7\frac{1}{2} \times 5\frac{1}{2} \times 2\frac{3}{4}$ inches \$12 00
237/224.	White Celluloid, embossed top, gilt metal centre and corners, extension base, bevel mirror in lid, sateen lined; fitted 5 articles. Size, $9\frac{1}{2} \times 7 \times 3$ in. \$19 20
237/226.	White Celluloid and plush, lithographed top with gilt metal filigree border, plush edge, sateen lined, mirror in \$24 00

237/238. Full Plush,

lid; fitted 6 articles.
Size, 9 × 6½ × 2¾
inches
gilt metal shield handle
centre and corner
ornaments, satin lined
and padded, fine bevel \$54 00
lid mirror; 7 pieces fine
fittings. Size,
10¾ × 8½ × 3 inches

CROCHET SETS.

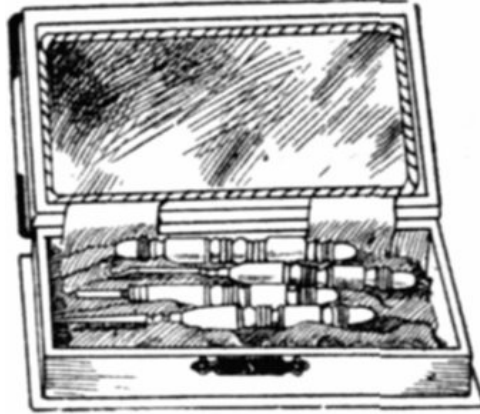

No. 237/268.

237/267.

Dozen.

Fancy paper covered,
imitation celluloid
picture top, gilt metal
ornaments; fitted 4 \$ 3 60
pieces

237/268.

Pink satin effect
celluloid, mirror inside
lid; fitted 4 pieces. \$ 4 00
Size, 4½ × 2¾ inches

Writing Companions.

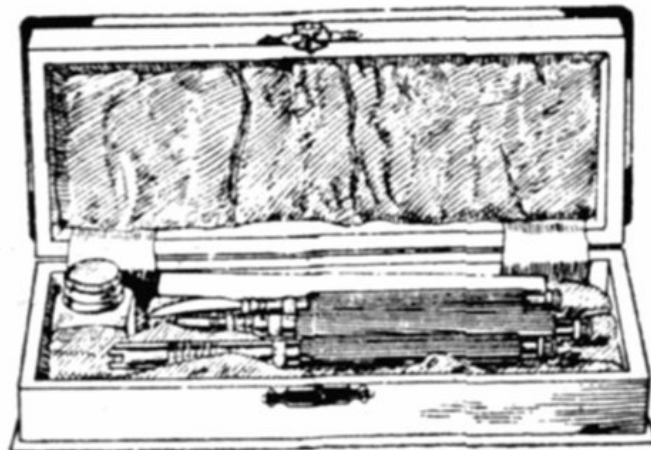

No. 237/265.

237/262.

Dozen.

Fancy paper covered,
imitation celluloid top
with picture, gilt metal
corner ornaments; \$ 4 00
fitted with pen, pencil,
ink knife and bottle.
Length, 6½ inches

237/263.

White Celluloid, gilt
metal corner
ornaments, sateen
lined; fitted with pen, \$ 6 00
pencil, knife and ink
bottle. Size, 7½ × 2½
inches

237/265.

As 237/263 but is larger, and in addition to fittings named has a letter opener \$ 8 00

237/266.

As above, but larger and has finer fittings \$12.00

Novelty Tapes.



Dozen.

376/50. Celluloid Hog,

2½ inches long. A 36 inch spring tape follows the shamrock pulled out of the pig's mouth \$ 4 50

376/51. Celluloid Beetle,

3½ inches long, 36 inch spring tape \$ 4 00

SEA SHELL GOODS.

836. Assorted Boxes,

diamond, square and oblong shape. Size, about 5 × 4 inches, 1 dozen in a package, dozen \$1 80



No. 293.

293. Box,

as cut. Size, 5½ × 4 inches, 1 dozen in package, dozen \$2 20

322. Box,

4 compartments, small pin cushion and picture on top; size, 6½ × 4¾ inches; ½ dozen in package \$ 4 00

111. Box,

small pin cushion on top, 4 compartments and 2 pin cushions inside; size, 8 × 5¾ inches; ½ dozen in package \$ 8 00

567. Footed Box,

pyramid top, fancy lined; size, 6 × 4 inches; ½ dozen in package \$ 5 50

568. Footed Box,

as above, but size 7½ × 5 inches and with lid mirror \$10 80



No. 541.



No. 535.

541. Fancy Box,

569. Triangle Box,

556. Oval Box,

Dozen.

as cut, pin cushion top;
 size, 3½ × 3½ inches; \$ 4 00
 ½ dozen in package
 length 5 inches, height
 3½ inches; ½ dozen in \$ 4 00
 package
 length 5 inches, height
 3 inches; ½ dozen in \$ 4 00
 package
 similar to cut, 1
 drawer, mirror, 2

538. Consol Table,

cushions, 2 end compartments; size, 5 inches long, 6 inches high; ½ dozen in package \$ 4 00

535. Consol Table

as cut, 1 drawer two end compartments; each in a package \$ 8 00

529. Ottoman Ink,

mirror front, drawer in end. Size, 4 × 3 inches; ½ dozen in package \$ 4 00

531. Oblong Plaque,

scene and seaweed under glass. Size 7 × 4½ inches; ½ dozen in package \$ 4 00

565. Corner Cupboard,

glass doors, one shelf. Height 7½ inches; ½ dozen in package \$ 4 00

540. Wardrobe,

glass doors, 1 drawer, 1 shelf. Height 6½ inches; dozen in package \$ 4 00

WOOD WORK BOXES.

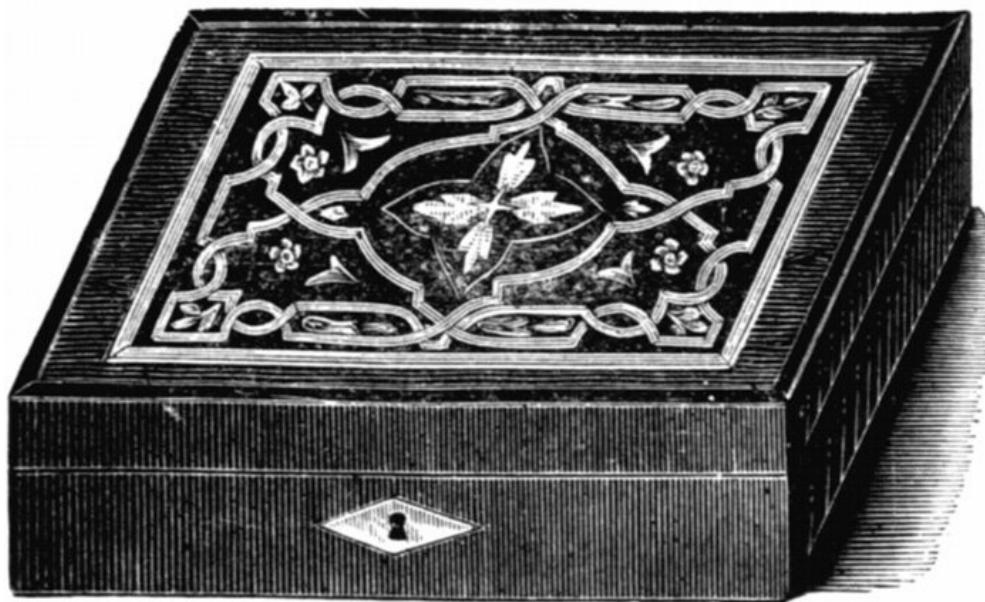

19/26.

Dozen.

Fine polished wood, with handsome lithograph top; fitted with small mirror in lid, scissors, needle holder and tape needle, with lock and key. Size, 8 × 5½ × 2½ inches \$ 4 00

19/27.

Similar to above, but has larger mirror and pin cushion. Size, 10¼ × 7¼ × 3½ inches \$ 8 40

19/28.

Similar to above, but has removable tray with 2 cushions and padded jewel compartment. Size, 12 × 8¼ × 4 inches \$16 00

Wood Box Writing Desks.

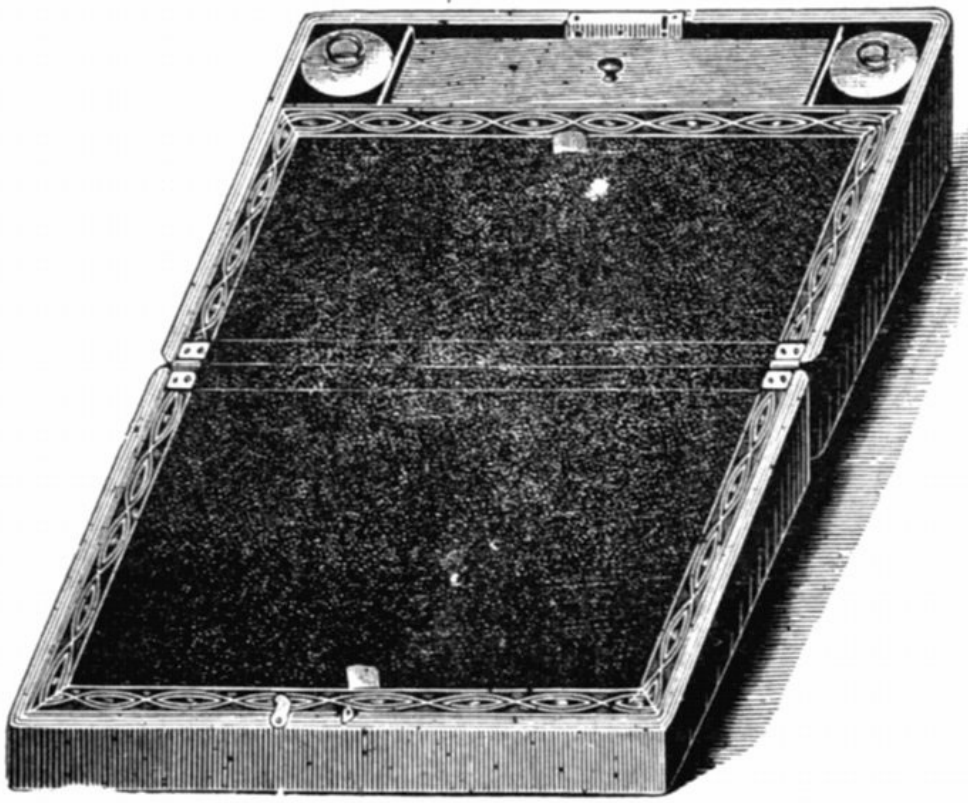

19/29.

14/690.

14/691.

14/692.

Dozen.

Fine polished wood box, with handsome lithograph flowered top. Writing surface is covered with plush. \$ 4 50
 Has compartments for writing materials. Size, open 11½ × 8½ inches
 As above, but size open 15 × 10½ in. \$ 8 40
 As above, but size open 16 × 12 in. \$15 00
 As above, but size open 25 × 18 in. \$19 20

MANICURE SETS.

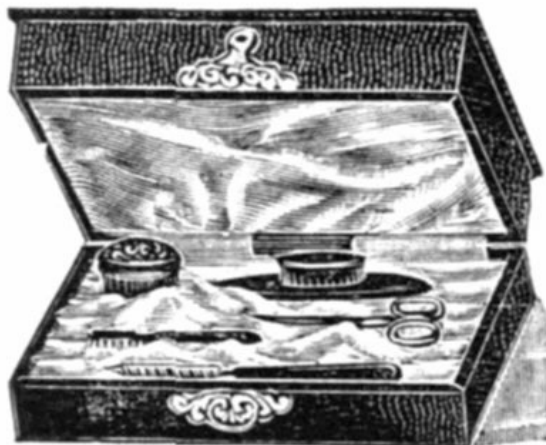

No. 320.

Leatherette, assorted colors; plush and satin

301/308.

lined; fitted six white manicure fittings. Size, 6½ × 4½ inches. Dozen, \$18 00

320.

Imitation seal. Embossed white satin lining; fitted five pieces plain ebony manicure fittings. Size, 7½ × 5 inches. Dozen, \$32 40



321.

Fancy shape. Full celluloid, dark base embossed fancy design, top gold celluloid with lithographed flowers and ideal head. Dozen, \$38 40

Fitted five white manicure fittings and china tray; satin lined. Size, 10 × 5½ inches

301/310.

Flat shape. Padded leatherette, plush and sateen lined; seven pieces manicure fittings. Size, 7½ × 5 inches. Dozen, \$40 00



No. 322.



No. 323.

322.

Ebony celluloid. Embossed fancy design, medallion heads; lined with white satin; fitted with fine sterling silver mounted ebony fittings. Size, 7½ x 5 inches

Dozen, \$48 00

323.

Ebony celluloid. Embossed cupids and fancy design; white satin lined; fitted with seven sterling silver mounted ebony fittings. Size, 8¼ x 5¾ inches.

Dozen, \$72 00

SMOKER SETS.



330.

Full celluloid; top embossed flowers in natural colors, pipe and word 'Smoker'; satin lined. Wood pipe, cigar and

Dozen, \$38 40

cigarette holder
and metal
match case.
Size, $7\frac{1}{4} \times 4\frac{1}{2}$
inches



331.

Fancy shape.
Full dark
celluloid with
flowers under
transparent; top
with cupid
frame and
colored
photograph
centre; satin
lined. Wood
pipe, cigar and
cigarette holder
and metal cigar
cutter. Size,
 $9 \times 5\frac{3}{4}$ inches

Dozen, \$48 00

Tobacco or Cigar Jar.

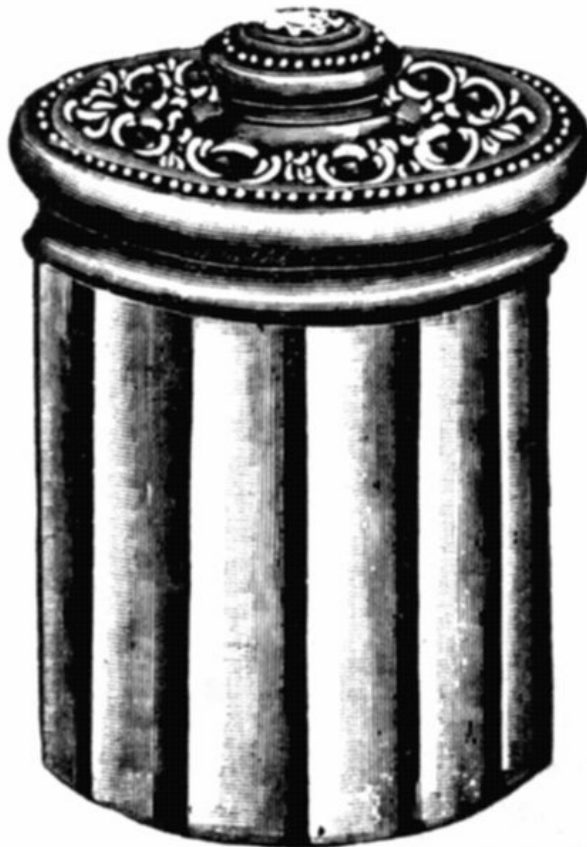

6013.

Crystal glass,
imitation cut;
handsomely
embossed satin
gilt metal top,
with sponge
holder. Height 6
inches

Dozen, \$18 00

JARDINIERES.



No. 2/7.

Globe shape, fancy scalloped top, white ground, gold traced dark **blue flower decoration**, clouded gold top.

- 2/5.
- 2/6½.
- 2/7.
- 2/10½.

Dozen.

Diameter 5 inches	\$ 5 50
" 6½ "	8 00
" 7 "	9 60
" 10½ "	36 00

Same shape as above, but with **colored flower decoration** on assorted pink and yellow, and green and yellow tints, clouded gold top.

- 4/5.
- 4/6.
- 4/7.
- 4/8.
- 4/9.
- 4/10.
- 4/10½.

Dozen.

Diameter 5 inches	\$ 5 50
" 6 "	6 50
" 7 "	9 60
" 8 "	16 00
" 9 "	24 00
" 10 "	30 00
" 10½ "	36 00

Same shape as above, cream ground, shaded top, gold edge, colored flower decoration.

Dozen.

- 2006/6.
- 2006/7.
- 2006/8.
- 2006/9.

Diameter 6 inches	\$12 00
" 7 "	18 00
" 8 "	24 00
" 9 "	33 60



No. 18/7.

As cut, gold traced blue flower decoration on white ground, gold foot, top and handles.

18/7.
18/8.

Dozen.

Diameter 7 inches	\$30 00
" 8 "	48 00

"Royal Bonn" Ware.



No. 1428/5.

As cut, Royal Bonn ware, beautifully decorated in rich colors, embossed top.

1428/5.
1428/4.
1428/3.

Dozen.

Diameter 7 inches	\$16 00
" 8 "	26 40
" 9 "	39 40

POTS ON PEDESTALS.

"Victor" Special, Majolica,

Each.

brilliant glaze, flowing colours shaded green and shaded red. Entire height, 24 inches; diameter of pot, 8 inches \$ 6 00

brilliant glaze, pretty modelled, can be had shaded dark and light

Soudan 2, Majolica,

green, or dark green and red. Entire height, 33 inches; diameter of pot, 11 inches

14 00

Soudan 3,

as above but larger. Entire height, 37 inches; diameter of pot, 13 inches

24 00

1432/2 1452. White ground,

colored flower decoration. Entire height, 28 inches; diameter of pot, 10 inches

14 00

Natural Preserved PALMS

All our Palms are native tropical plants, and are so prepared by a chemical process that they will not fade, but retain all the grace and beauty of the living palm.

They require no care or water, and are not affected by heat, cold, gas, steam, or any atmospheric influence.

They are entirely free from dirt and moisture, consequently are the best, cheapest and most practical articles for decorating homes, hotels, churches, stores, restaurants, etc.



CHAMAEROPS.

Chamaerops.

Each plant is in a neat moss-filled earthen pot.

3 leaves,
5 "
6 "
9 "
12 "

Dozen.

1½ ft. high,	\$ 9 00
2½ " "	19 20
3 " "	24 00
3½ " "	38 40
4 " "	54 00

Elegans Tree.

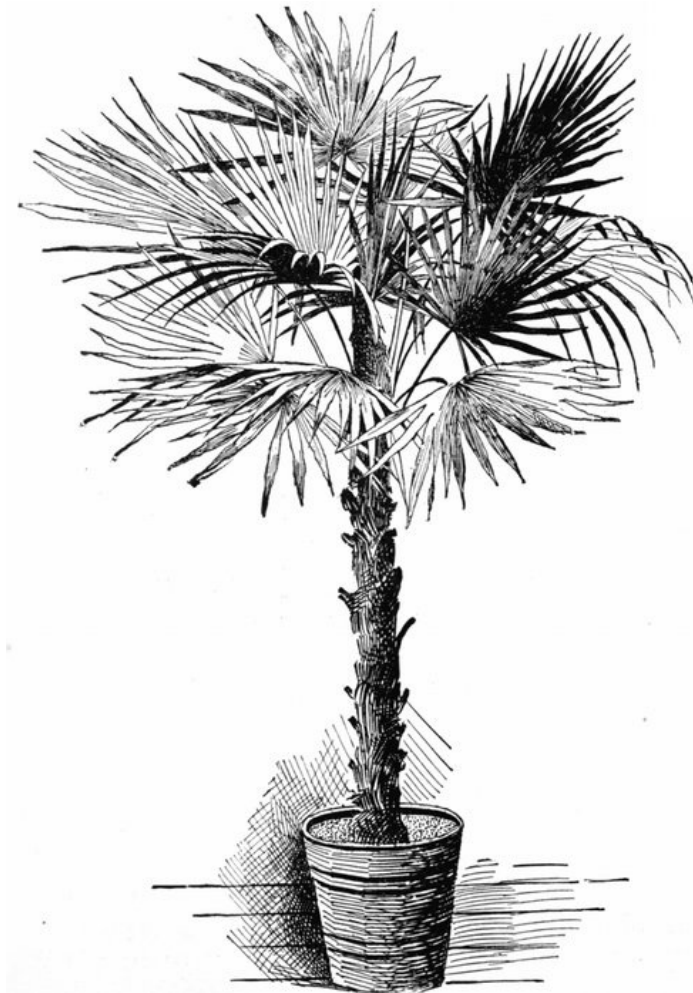

ELEGANS TREE.

Each in large well-made green wooden tub with iron handles.

12 leaves,

Each.

9 feet high,	\$14 00
--------------	---------

GRASSES.

PRESERVED AND POTTED.

No. 1.
No. 2.
No. 3.

Small size	Dozen, \$ 7 20
Medium size	" 12 00
As cut	" 16 00



No. 3. Grasses.

CYCAS, or SAGO PALM.

A very beautiful and naturally preserved species. Each in an earthenware pot.
 4 leaves,
 5 leaves,

2 feet high	Dozen, \$38 40
2 feet high	" 48 00

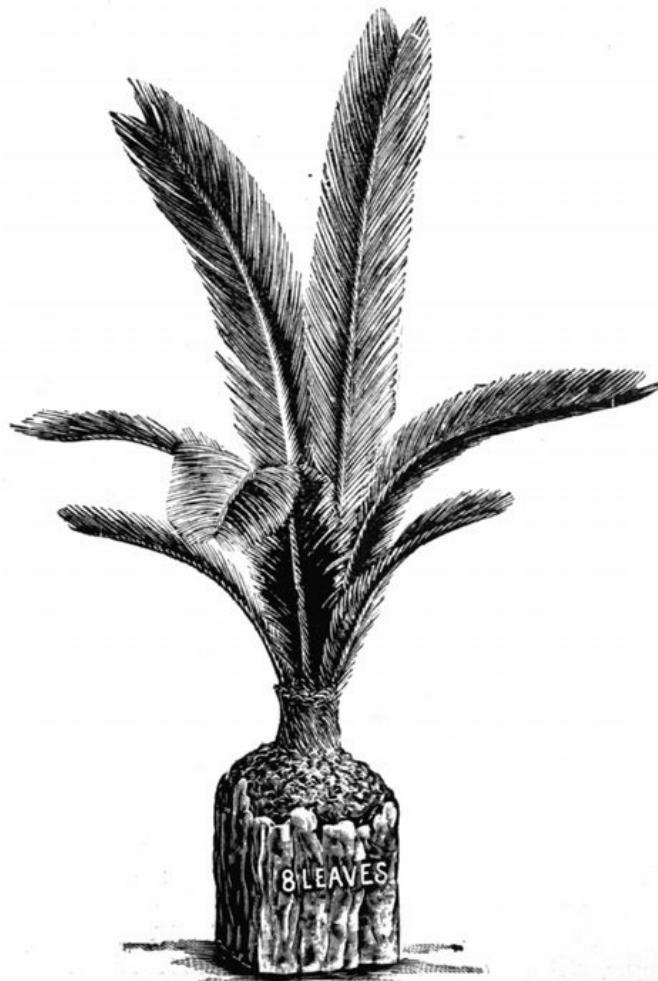

CYCAS OR SAGO PALM.

Hanging Baskets.

8 inch wire frame.

Filling consists of several species of preserved palm leaves, grasses, drooping vines, roses and begonia leaves. Each, \$6 00

Vines.

For Decorating.



Smilax leaves, 2 spray

Ivy vines, as cut

Autumn vines, tinted colors

Dozen yards, \$3 50
 " " 4 00
 " " 4 00

Artificial Flowers.

With extra long stems and foliage, suitable for filling vases, jardinières, etc.

Beauty Roses

Double Carnations

per Dozen, \$2 50
 " 3 00

TOY DRUMS.

(Pair of sticks with each.)



No. 412/5 & 412/6.

Lithographed tin shell, tin hoops striped in red, white and blue.

412/2.

412/3.

412/4.

As cut. Brass lacquered shell, painted wood hoops, four steel screws and clamps. A very strong and serviceable line.

Dozen.

Diameter 6 inches, 1/2 dozen in package \$ 3 20
 " 6 1/2 " 1/2 " " 4 00
 " 8 " 1/3 " " 6 50

Dozen.

412/5.

412/6.

Diameter 9 inches \$ 8 40
 " 10 " 12 00



International.

International Flag drum is made with wood shell and hoops, and has lithograph decoration showing flag bearers from all nations.

**International—
International—**

Dozen.

9 inch diameter	\$14 40
10 " "	18 00

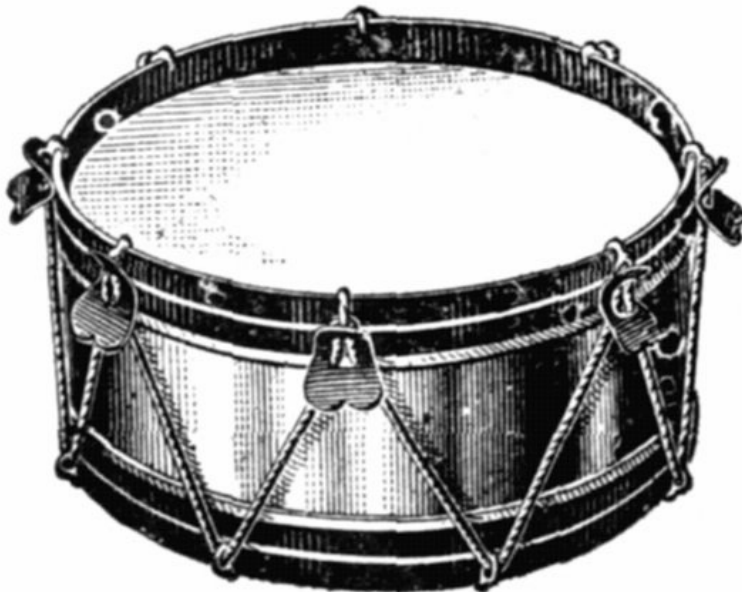

No. 101/10.

101/10.

101/12.

Dozen.

Military kettle drum. Diameter 10 inches. Brass shell, nickel plated, genuine calfskin head, very strongly made and finely finished	\$26 40
Same as 101/10 but diameter is 12 inches	30 00

DOLL CHAIRS.



No. 770.



No. 660.

770.

660.

Dozen.

As cut. Rocking chair;
white enamel finish,
bronze top knobs. \$ 3 20

Height 13 inches; size
of seat, 6 × 5¼ inches

As cut. High chair;
white enamel finish,
bronze top knobs. 3 20

Height 18 inches; size
of seat, 6 × 5¼ inches

FURNITURE SET.



5.

Dozen Sets.

As cut. Finished on natural wood. Consists of table, size, 9 x 6 inches and 5½ inches high; 2 reception chairs 7 inches high, and rocking chair to match. Each set picked in a box \$ 6 50

Toy Carpet Sweeper.



Dozen.

Bissell's "Little Helper"

is a practical toy. It will pick up paper, straws, chips, dirt, thread, etc., from a carpet, the same as a full-sized carpet-sweeper \$ 4 00

TOY FURNITURE.

Strong and serviceable toy sizes of Favorite House Styles.

BUREAUS.



No. 3 1/2.

2 1/4.

2 1/2.

15.

3 1/2.

Dozen.

Whitewood, varnish finish; 3 long drawers, extension back. Size, 5 1/2 x 3 inches. Height, 6 inches. 1 dozen in package

\$1 30

Hardwood, varnish finish; 3 long drawers, extension back. Size, 7 x 4 inches. Height, 7 3/4 inches. 1/2 dozen in package

2 40

Hardwood, varnish finish; 3 long drawers, extension back, top covered compartments. Size, 8 3/4 x 4 1/2 inches. Height, 8 1/4 inches. 1/2 dozen in package

4 80

As cut. Hardwood, varnish finish; 2 long drawers, 4 short drawers. Size, 10 x 6 inches. Height, 9 1/2 inches. 1/6 dozen in package

7 20

WASHSTANDS.

3.

Hardwood, varnish finish; 1 long drawer, 2 short drawers, 1 door compartment, high back with rod for splash. Size, 10 x 6 inches. Height, 13 inches. 1/6 dozen in package

4 80

EXTENSION TABLE.

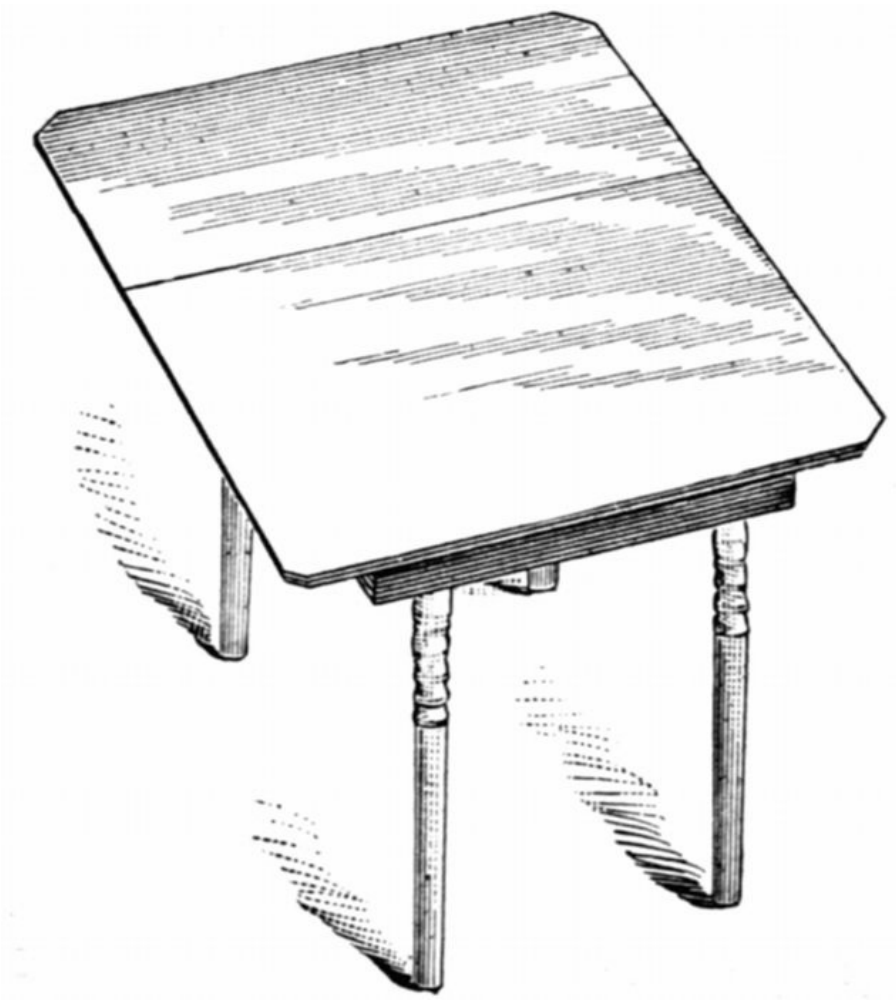

As cut.

Dozen.

Hardwood, varnished top. Length, with extension board in, is 14 inches. Height 9½ inches

\$3 40

SIDEBOARDS.



No. 15.

2¼.

2¾.

15.

3½.

Dozen.

Whitewood, varnish finish; 1 long drawer, double doors, extension back. Size, 5¼ × 3 inches. Height, 6 inches. 1 dozen in package \$ 1 30

Hardwood, varnish finish; 1 long drawer, double doors, extension back. Size, 7¼ × 4 inches. Height, 7½ inches. ½ dozen in package 2 40

As cut. Hardwood, varnish finish; 1 long drawer, double doors, high extension back with shelf. Size, 8½ × 4½ inches. Height, 11½ inches. ¼ dozen in package 4 80

Similar to No. 15, but has more fancy top, and size is 10 × 6 inches. Height 13 inches. ¼ dozen in package 7 20

FOLDING TABLE.

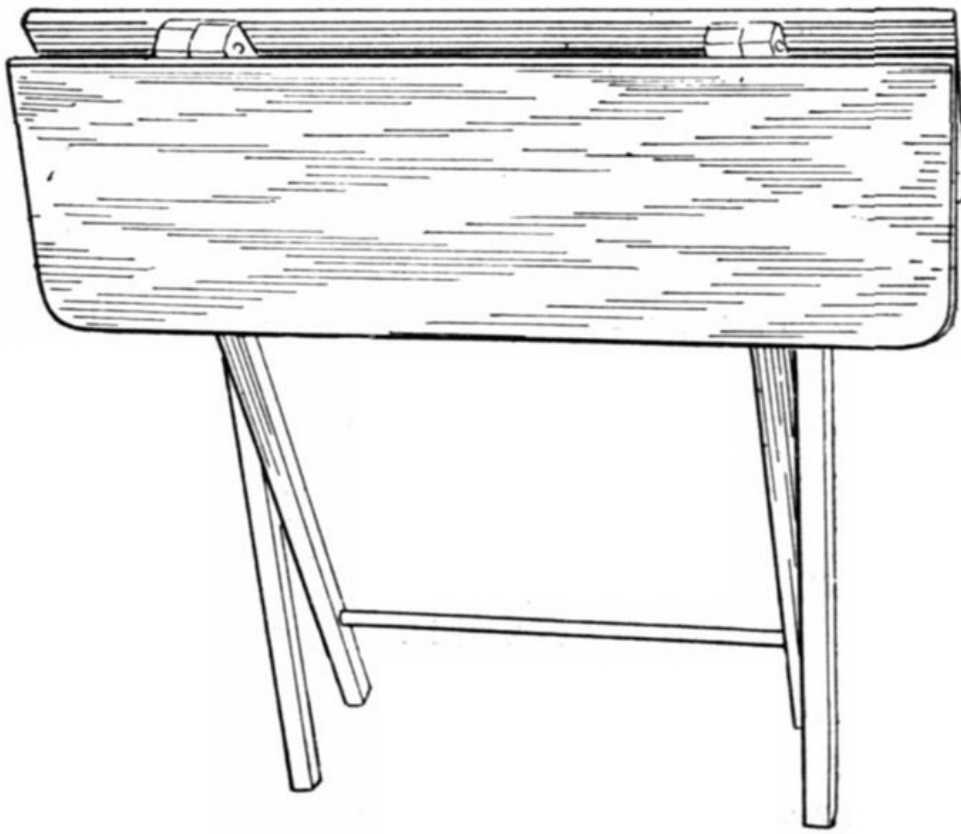

As cut.

Dozen.

Hardwood, varnish
finish. Length, 18
inches. Height, set up,
13 inches

\$5 50

WOOD DOLL CRADLES.

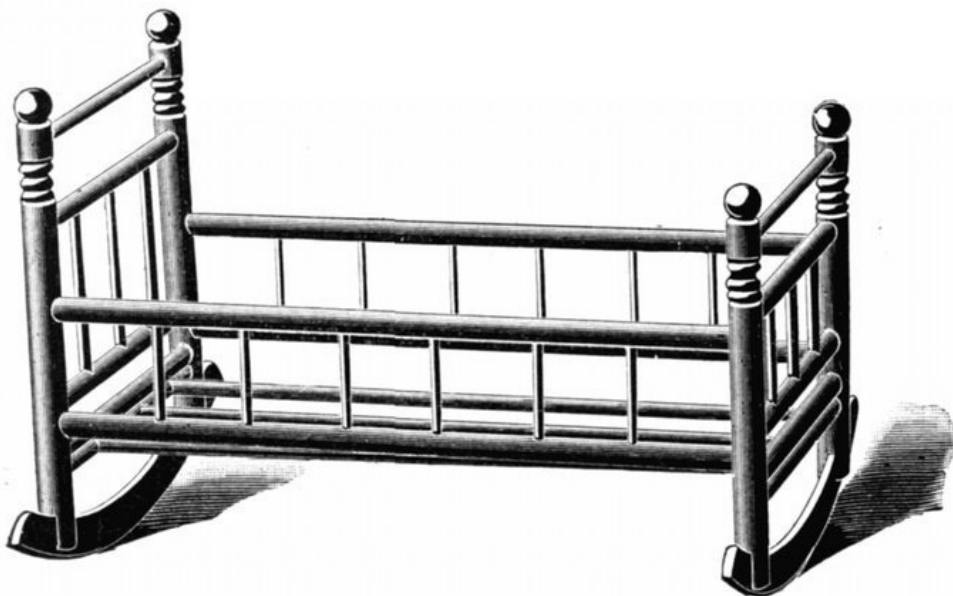

No. 1.

1.

2.

3.

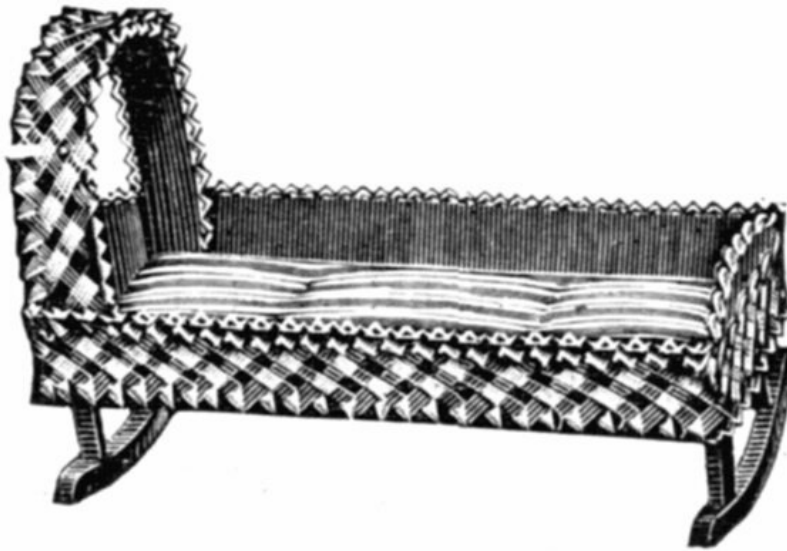

Dozen.

As cut, varnished on natural wood. An extra large cradle for price, being 18 inches long and 11 inches wide. Easily set up \$4 80

White enamel and gilt, fine finish. Folds completely for packing and is easily set up. Length 22 inches, width 12 in. 10 50

Finished in white enamel and gilt, a very large and elegant cradle. Like Nos. 1 and 2, it comes knocked down flat for packing, but is easily set up Length 24 inches, width 14 inches 20 40

1C.

Dozen.

As cut. Stained wood body, trimmed with wood splint Indian work in bright colors. Fancy canvas-covered movable bottom. Size, 8½ x 16 inches \$8 00

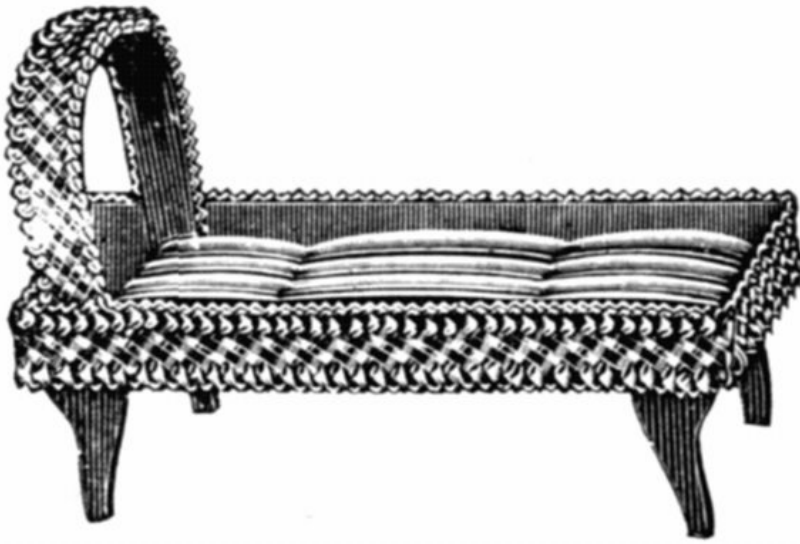

1B.

Dozen.

As cut. Stained wood body, trimmed with wood splint Indian work in bright colors. Fancy canvas-covered movable bottom. Size, 8½ × 16 inches

\$8 00

STEEL DOLL CRADLES AND BEDS.

Baked Enamel Finish, in Brilliant Colors.

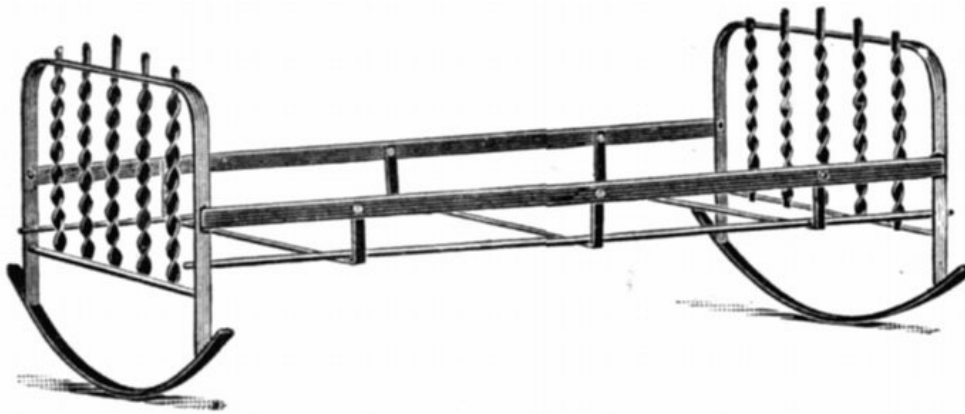

No. 0025.

As cut.

All steel body, made in a very artistic and strong design. Bright and attractive colors.

Dozen.

0010.

Size, 5 × 10 inches; ½ dozen in bundle

\$2 50

0025.

Size, 9 × 18 inches; ½ dozen in bundle

6 00

0050.

Size, 12 × 24 inches; ½ dozen in bundle

12 00

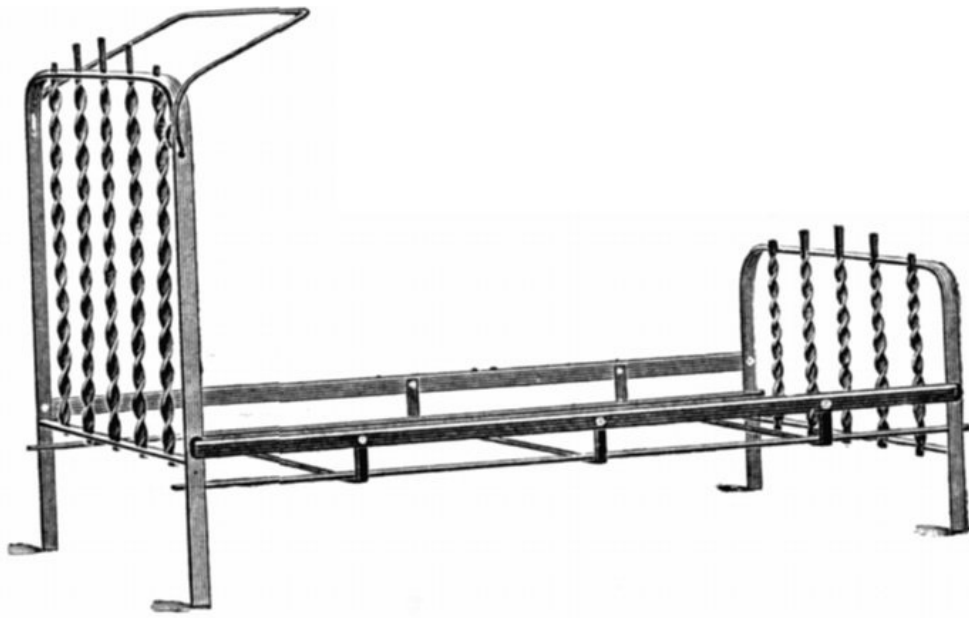

No. 025.

As cut.

010.

025.

050.

All steel body,
in same quality
of material and
workmanship as
our steel
cradles.

Dozen.

Size, 5 × 10 in.;	
packed ½ doz. in pkg.	2 50
Size, 9 × 18 in.;	
packed ½ doz. in pkg.	6 00
Size, 12 × 24 in.;	
packed ½ doz. in pkg.	12 00

STEEL DOLL SWINGS.

Baked Enamel Finish.

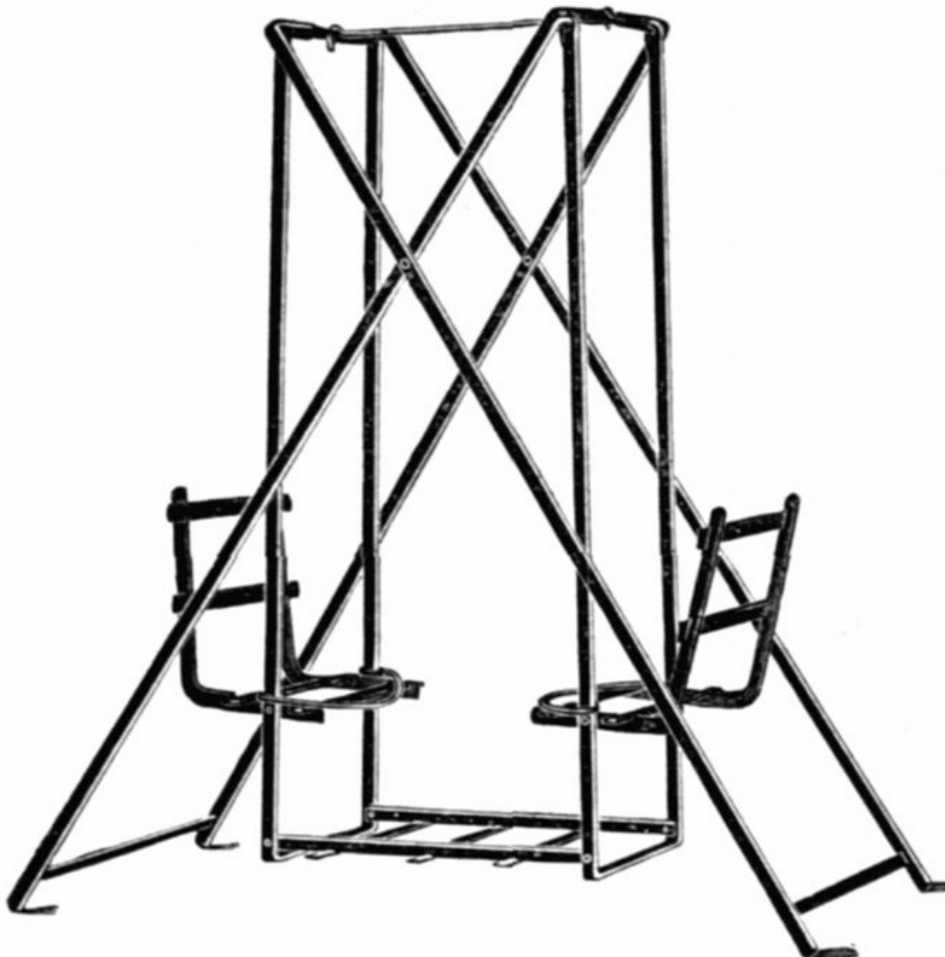

No. 250.

250.

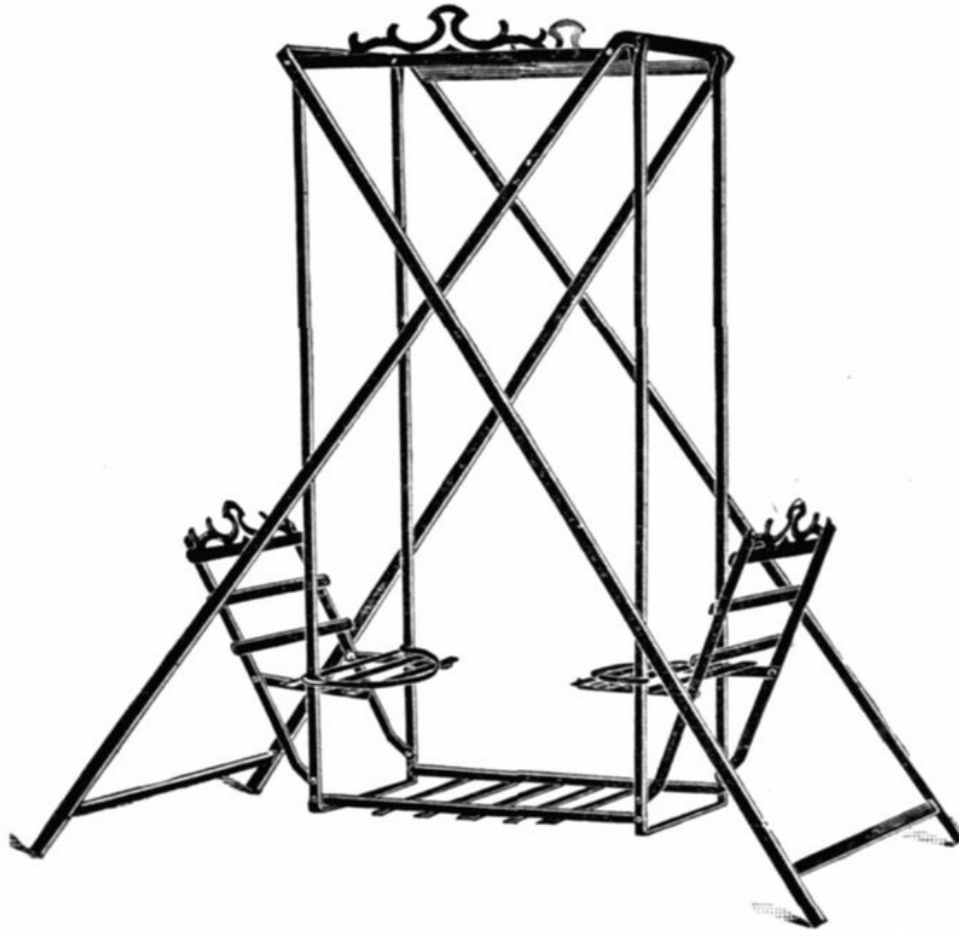

No. 500.

500.

INDIAN DOLL SWING.

Dozen.

As cut. An attractive double seated design, in bright baked enamel finish. It is riveted throughout and will, like our steel cradles and beds, stand any amount of hard usage. Height, 15 inches; length, 14 inches. Folded and packed, ½ dozen in box

\$5 50

Dozen.

As cut. Similar to No. 250, but larger and more elaborate in design. Comes finished in crimson, blue and white enamel. Height, 21 inches; length, 20 inches. Folded and packed, ½ dozen in paper box

\$12 00

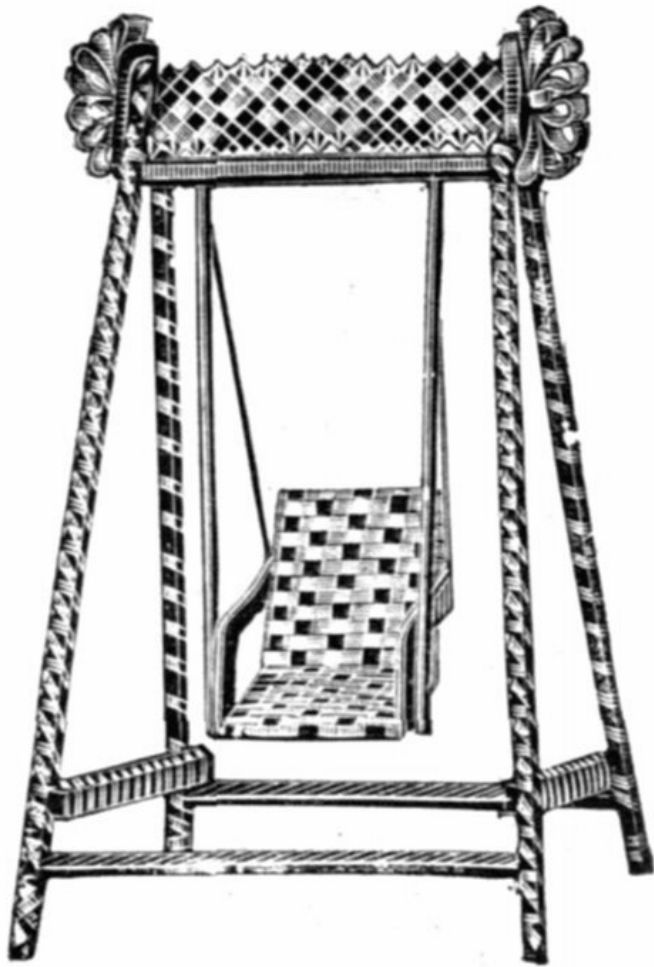

No. 1.

1.

As cut. Fancy folding, stained wooden frame, trimmed with wood splint Indian work in bright colors. Height, 18 inches; length, 12 inches. 1/2 dozen in pkg. Per dozen

\$5 00

Doll Hammock.

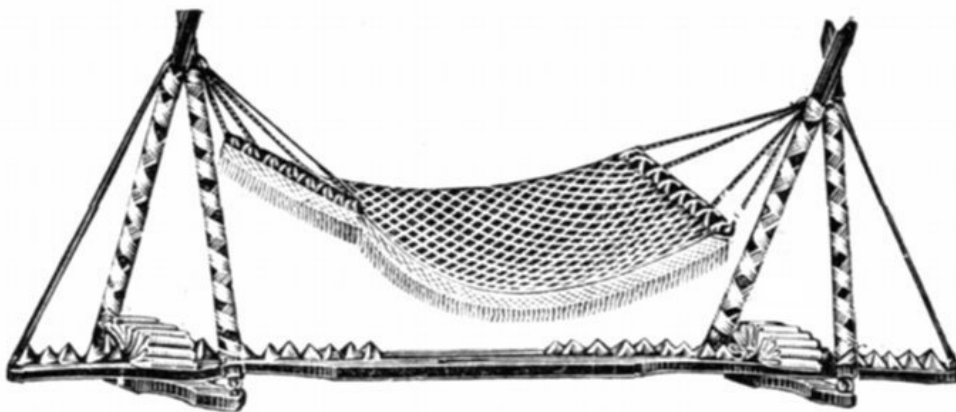

No. 1.

1.

Dozen.

As cut. Fancy woven net hammock on folding stained wood stand; trimmed with splint wood Indian work. Entire length, 33 inches. 1/2 doz in package

\$8 00

Doll's Reclining Chair.

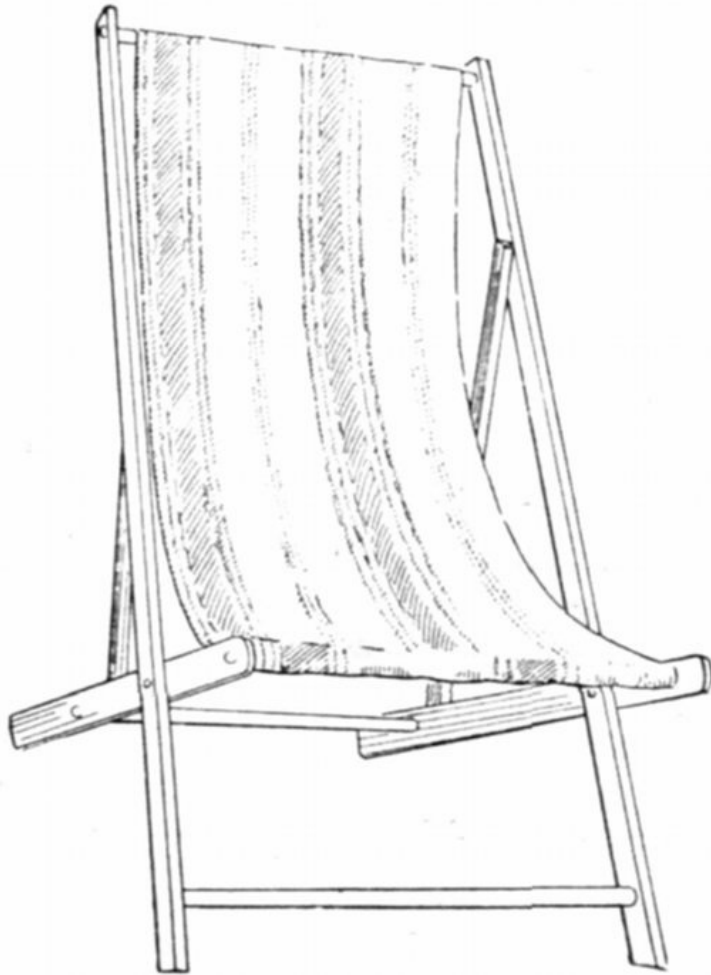

As cut.

Dozen.

Red painted wood folding frame, fancy colored canvas. Height, \$3 80
18 inches; length, 19 inches

LAUNDRY SETS.

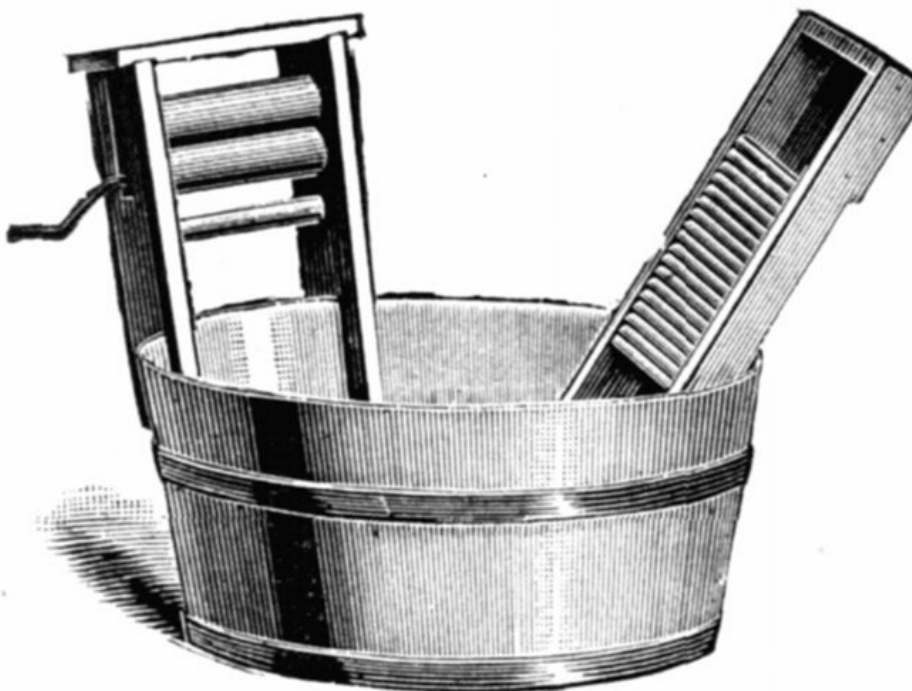

No. 100.

Dozen Sets.

Contains a 10 inch tub,



No. C.

Dozen Sets.

A. Columbia Set.

Contains five pieces, bench, tub, wringer, clothes horse and washboard, all nicely finished, each in a package. Size of bench set up, 11½ × 6½ inches \$5 50

B. Columbia Set.

Contains six pieces, bench, tub, wringer, clothes horse, washboard and pail, all handsomely finished, each in a package. Size of bench set up, 17 × 9 inches \$12 00

C. Columbia Set.

The most complete set made, contains 8 pieces,—bench, tub, wringer, clothes-horse, washboard, pail, sad iron and stand, all handsomely finished, each in a package. Size of bench set up, 23 × 11½ inches \$22 00

Wash Tub.

10-inch, strongly-made, metal hoops

Dozen.

\$ 2 40

Pail.

7-inch

\$ 2 40

TOY IRONING TABLE.

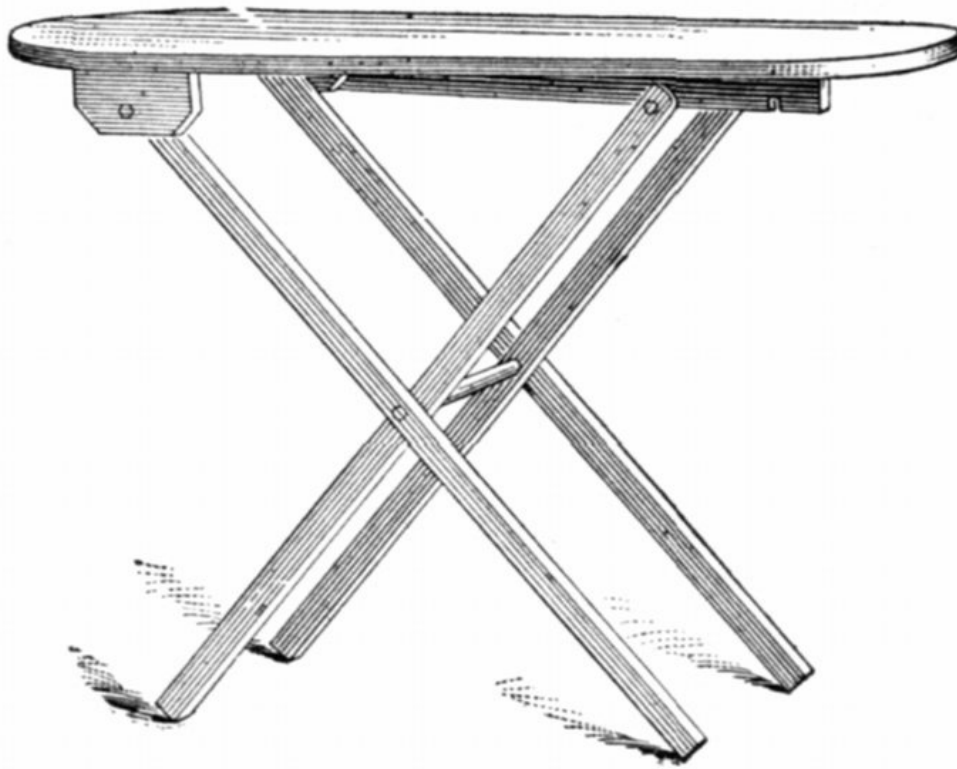

As cut.

Dozen.

Natural wood, strong and neatly finished; folding stand. Presents extra value for 25 cent retailer. Length, 24 inches; height, 16 inches \$3 20

Toy Buck and Saw.

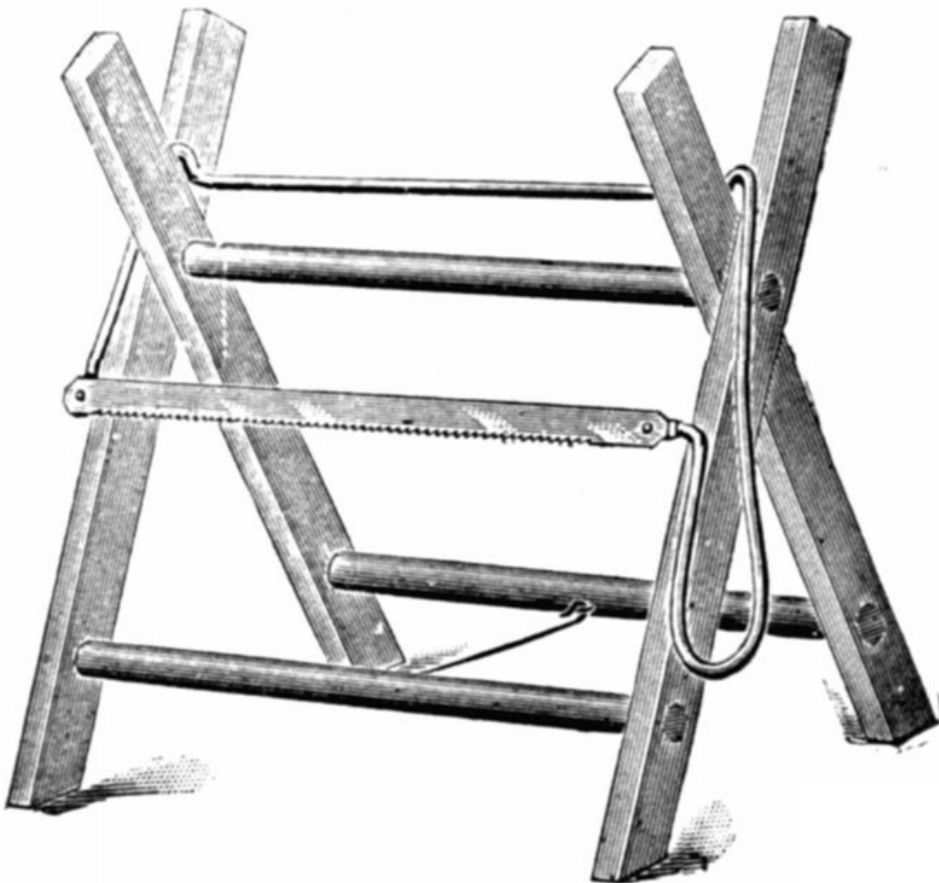

"Little Midget."

Dozen.

Heavy copper wire frame buck-saw, 11 inches long. Stained \$ 2 00

wood folding buck, 10 inches long and 9½ inches high

Toboggan Coaster.

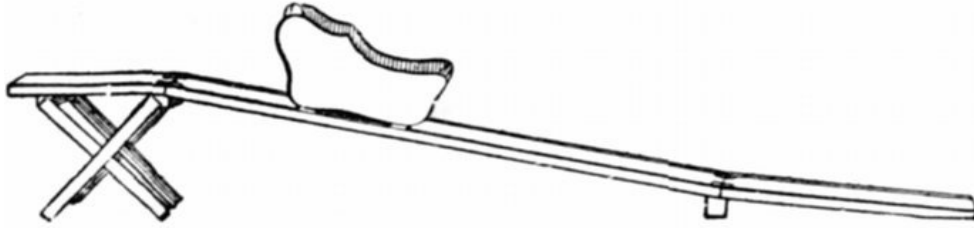

As cut.

Dozen.

Stained wood track slide, 6 inches high at one end and 34 inches long; folds and packs up snugly. Fancy car on rollers, 6½ inches long

\$3 60

TOY CRUISERS.

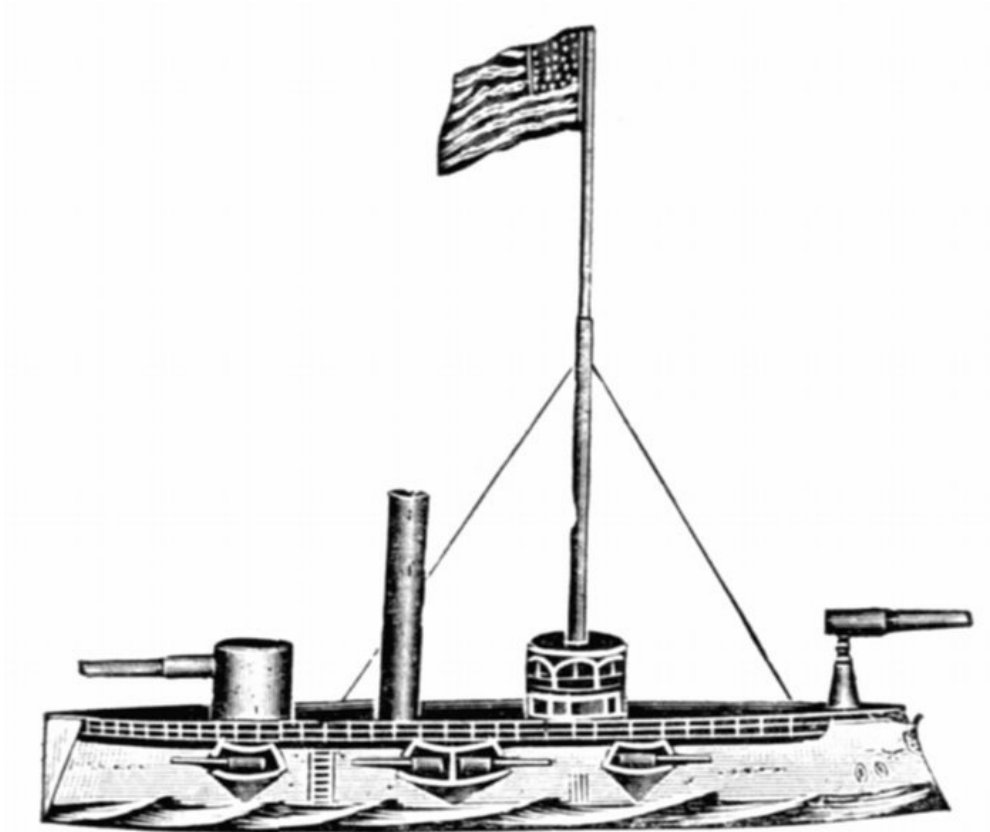

No. 482.

482. Torpedo Boat "Plunger."

Dozen.

A very attractive boat, in entirely new colorings, furnished with flags, cannon, mast, etc. The largest and best boat on the market for the money. 15 inches long by 13 inches high

\$ 2 50

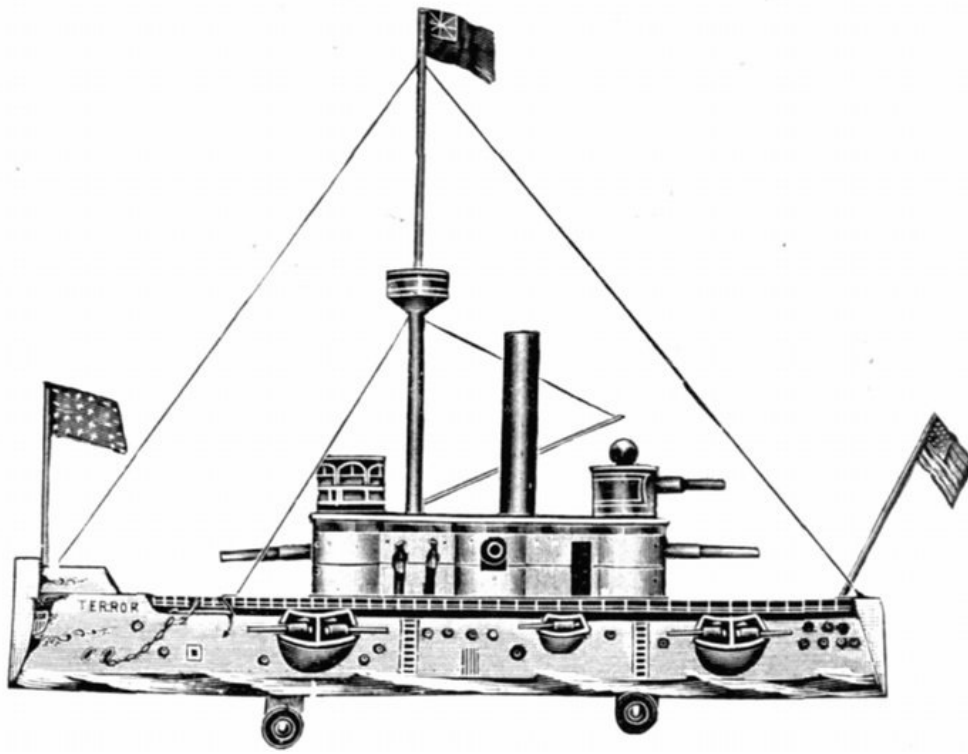

No. 483.

483. Battleship.

Dozen.

Our new boats are even handsomer than last year's designs, having embossed cabins and armors. This size is equipped with medium and small modern-shaped cannon, masts, rigging, flags, sailors, etc. 22 inches long by 20 inches high. Handsomer and better finished than any other on the market at the price

\$ 6 00

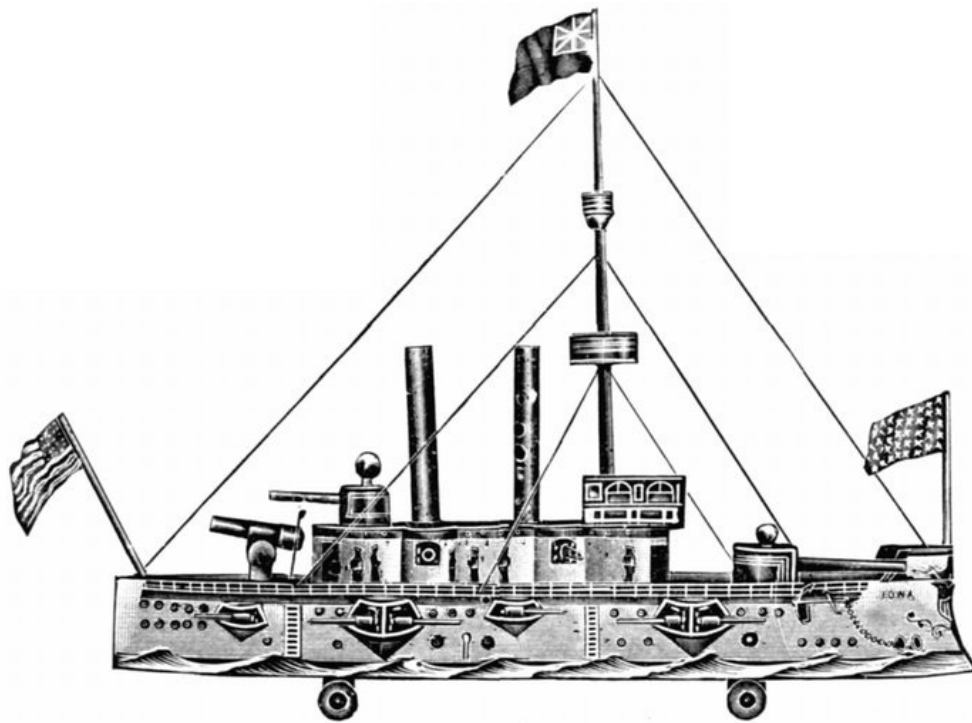

No. 484.

484. Battleship.

Dozen.

Modeled after the largest and most formidable vessel in the Navy. 30 inches long, and elaborately lithographed in colors and gold. Fully equipped with sailors, masts, rigging, flags, and cannon which fire caps and projectiles. Diagram for setting up with each boat

\$13 00

485. Battleship.

This is conceded to be the largest, finest, and best equipped boat ever placed on the market. Has embossed cabins and turrets, large cannon which fire caps and projectiles, and numerous small cannon, sailors, etc. Lithographed in new colors, with gold relief, shellac finish. Diagram with each boat for setting up. Length 37 inches

\$26 40

SLEIGHS.

Every number is a strongly built and well finished Sleigh, and, coming in beautifully assorted top designs, they present the most saleable line on the market.



Dozen.

722x.

Bent Knee Sled; finished on natural wood, except top which is painted in different colors and nicely ornamented in variety of styles. Length, 31 inches; width, 10 inches. (1/2 dozen in crate) \$8 40

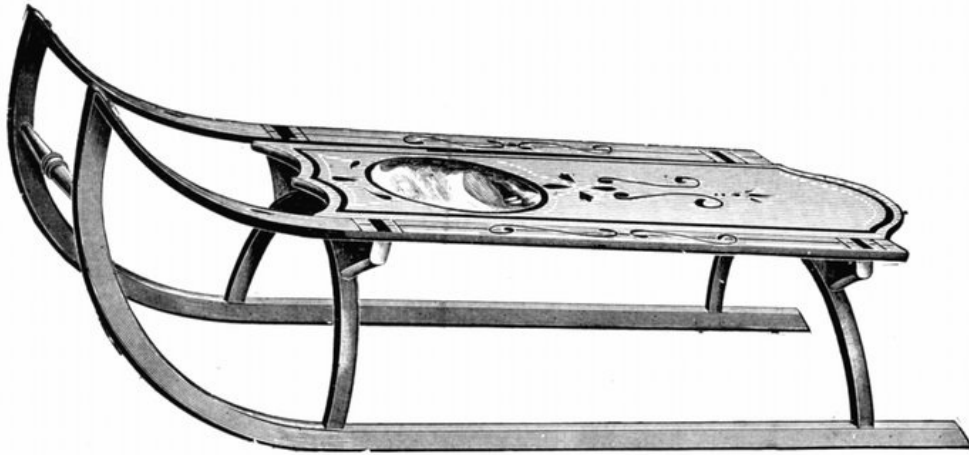

No. 716x.

716x.

Bent Knee; varnished on the wood, tops are nicely ornamented in assorted designs. Length, 34 inches; width, 13 inches. An extra large and fine sled at a low price. (1/3 dozen in crate) \$13 50



No. 717.

717.

Finished on natural wood. Tops are tastily ornamented in assorted designs. Knees are tapered and are both glued and securely nailed to both runners and beams. Fancy goose necks. Length, 35 inches; width, 12 inches, (1/3 dozen in crate) \$14 40



No. 713.

Dozen.

As cut. No. 713, but without Swan necks. This sled has wide raves; knees are bent in half circle and set at an angle which adds greatly to the strength of the sled. It is strongly braced; frame is varnished on natural wood and the tops show a variety of beautiful designs. Length, 34 inches; width, 13 inches. (1/3 dozen in crate) \$17 50

716.

Same as No. 716, but has nicely tinned Swan necks and **oval** shoes, making a very desirable and attractive sled. (1/3 dozen in crate) 21 60

713.

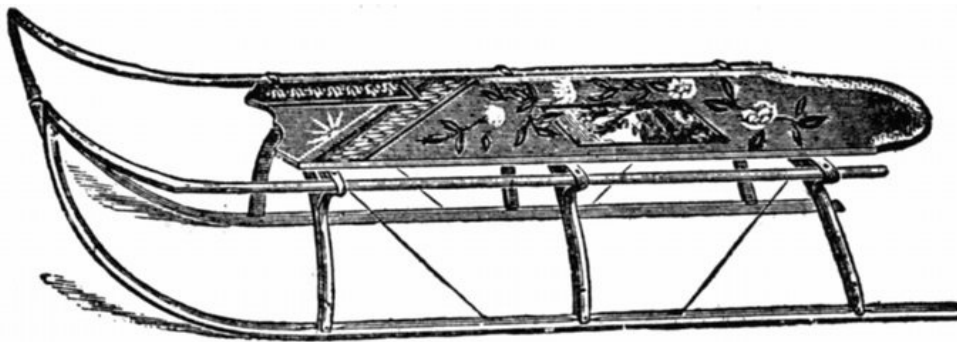

No. 79.

79. Oak Sled.

An ideal production, made of the best selected oak, finished on natural wood, beautifully decorated tops. Is shod with half oval shoes extending over the noses. Knees are well braced to runners and all side braces are riveted through both knees and runners. For strength, style and finish this sled cannot be surpassed. Length, 34 inches; width, 11 inches. (1/6 dozen in crate) \$24 00



No. 76.

76.

A fine sled made of the best quality of hardwood, painted in bright colors and nicely ornamented. Has large Swan necks, half oval shoes, and is well braced and brightly trimmed. Length, 38 inches; width, 15 inches, (1/2 dozen in crate) \$33 60

BOYS' SLEDS.

All have new hand painted top decorations.

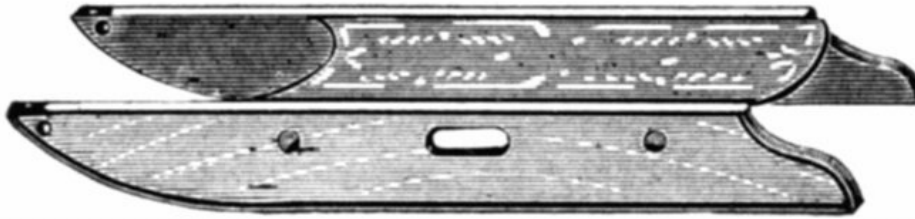

1.

Dozen.

28 inches long, 10 inches wide, nicely painted and decorated, with hand holes \$3 80

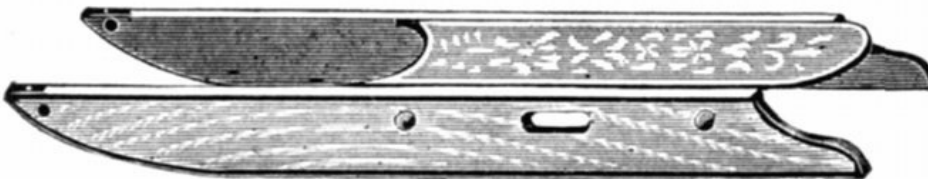

2.

33 inches long, 10 inches wide, nicely decorated, with handle holes \$4 50

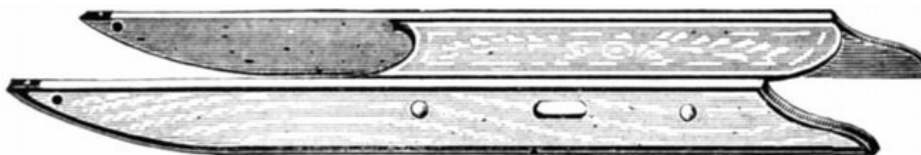

3.

38 inches long, 10 inches wide, nicely hand painted \$5 00

Clipper Coasters.

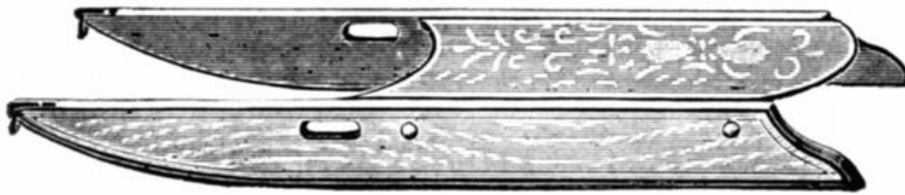

"Victor."

33 inches long, 10½ inches wide, with hand holes, round spring shoes, nicely painted and striped \$8 40

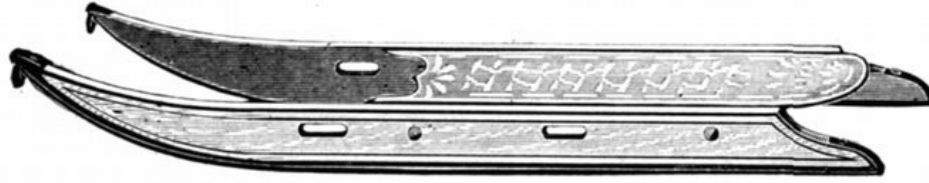

"Sport."

Strongly made of best hardwood, tops painted, sides varnished on the wood, beautifully decorated with new designs, and has round spring shoes. Length, 40 inches; width, 10½ inches \$11 80

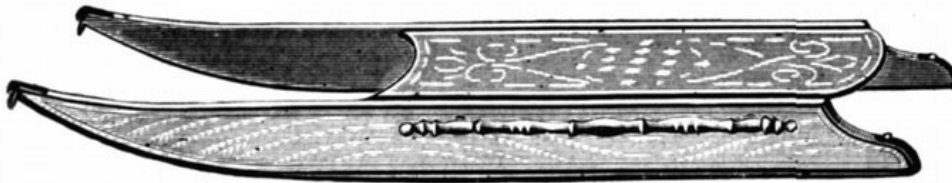

"Racer."

A large, strong and beautiful sled, with fancy turned side-rails, and heavy, round spring shoes. Length, 44 inches; width, 15 inches \$14 00

Specify whether you wish above sleds shipped, crated, or in bundles.

BENT RAIL SLEIGHS.

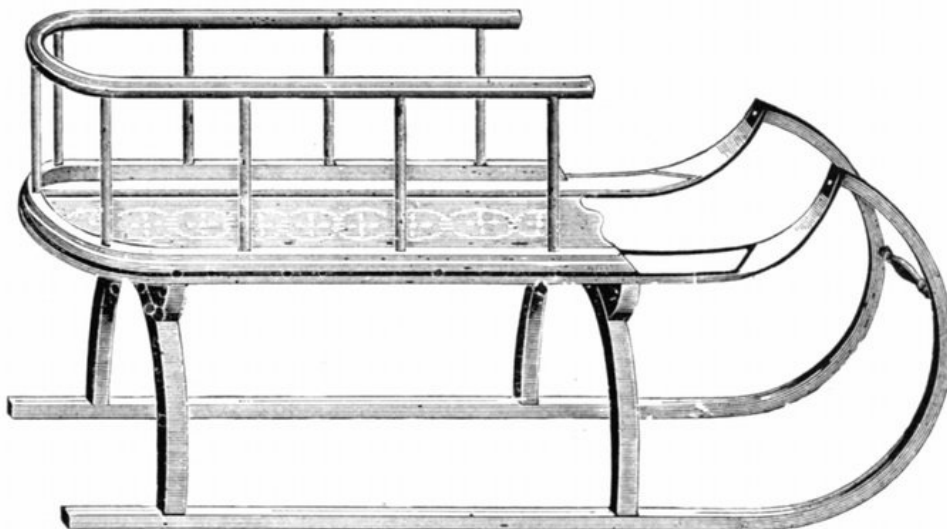

"Comfort."

42 inches long, 13 inches wide, nicely painted and striped Dozen, \$15 00

"Bent Rail."

20 inches long, 11 inches wide, frame varnished, seat Dozen, 12 50

board painted
and striped

BABY SLEIGHS.

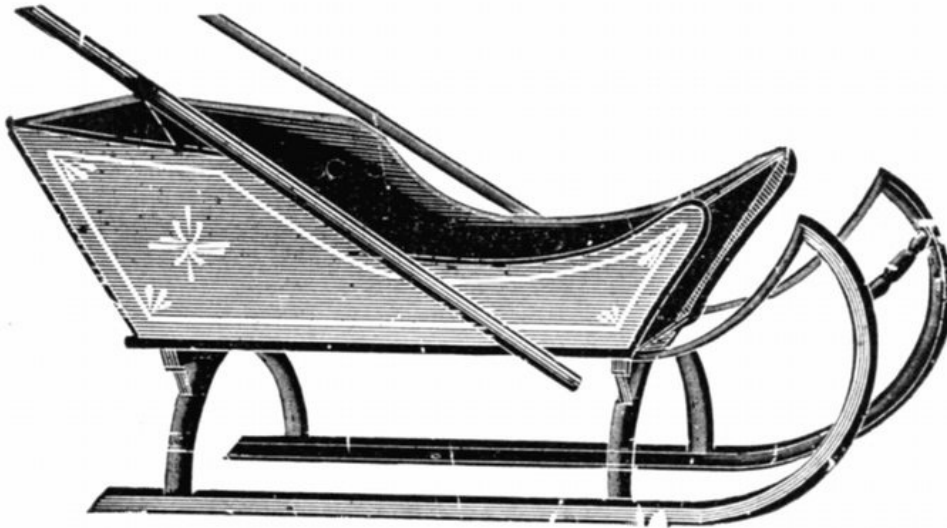

"Popular."

Has reversible handles to push or draw, body painted, framework varnished on the wood, well finished and nicely striped throughout. Length of body, 28 inches; width, 11½ inches

Dozen, \$23 50

"North West Comfort."

Similar to "Popular" but much larger, box being 30 inches long and 15 inches wide

Dozen, 32 00

SHOO-FLY ROCKER.



1.

Improved design, . Horses painted dapple grey. Hardwood rockers, Dozen, \$14 40
finished on natural wood and striped, red painted seat

2.

A much larger Rocker than No. 1, finished in superior style, strong and well made Dozen, \$19 20

Specify whether you wish these Rockers shipped "set up" or "knocked down."

PLUSH ROCKING HORSES.

Made of paper fibre, and covered with best quality wool plush. All have hair tail and mane, felt saddle-cloth, tan leather saddle and bridle. Rockers grained and varnished.

	Each.	
408/7.	Height from floor to saddle 20 inches	\$ 6 00
408/8.	Height from floor to saddle 22 inches	8 00
408/9.	Height from floor to saddle 24 inches	10 00
408/10.	Height from floor to saddle 29 inches	14 00

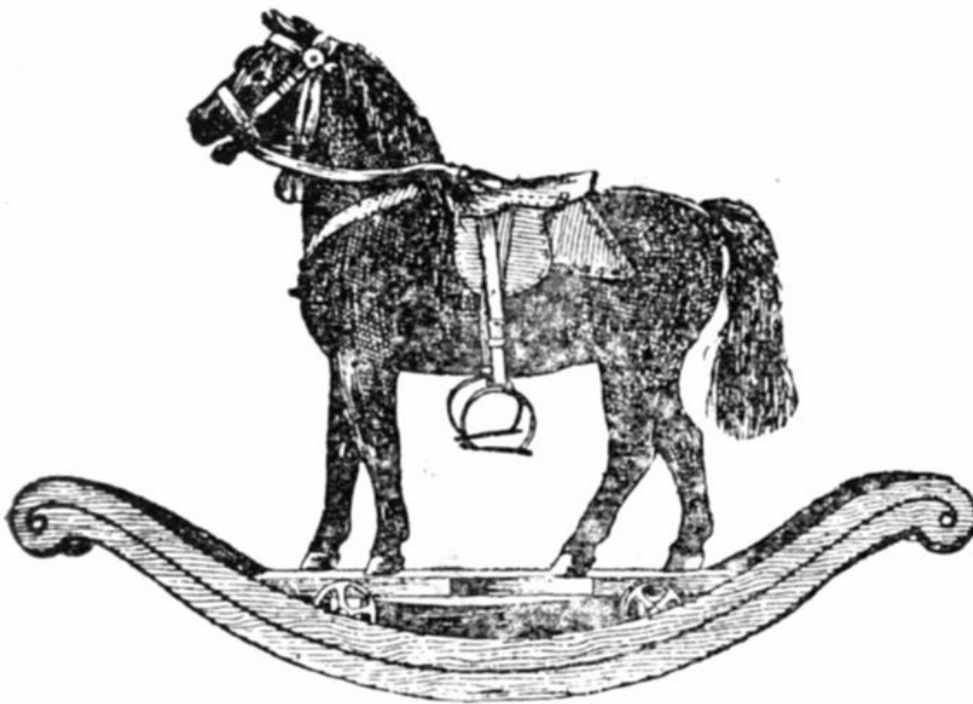

No. 408/11.

PLUSH, Combination,

Being mounted on platform with wheels, and can be detached or refitted to rocker in two minutes.

PLATFORM AND ROCKERS GRAINED AND VARNISHED.

408/11.

408/12.

408/13.

Each.

Height from floor to top of saddle 24 inches	\$10 00
Height from floor to top of saddle 27 inches	13 00
Height from floor to top of saddle 30 inches	18 00

WOOD ROCKING HORSES.



25.

35.

Dozen.

Well shaped body, thug legs, red painted rocker, oilcloth covered Mexican saddle, hair tail; entire height of horse 21 inches; length of rocker 43 inches. Assorted white and grey dapple. Packed ¼ dozen in a crate
 As cut, but with stirrups, has oilcloth covered Mexican saddle, hair tail and mane, red painted rocker; entire height of horse 25 inches; length of rocker 52 inches. Assorted white and grey dapple. Packed ¼ dozen in a crate

Plush Horses on Platforms.

Horses are covered with wool plush, have tan-colored saddle and bridle; mounted on varnished platforms with iron wheels.



No. 408/1.

408/1.

408/2.

408/3.

408/4.

408/5.

408/6.

Dozen.

Entire height, 7 inches,	\$ 4 00
platform 6¼ inches	
" " " 9½ " " 8	8 00
" " " 12 " " 9½	12 00
" " " 15 " " 13	18 00
" " " 16 " "	21 60
13½ " " 17 " "	27 60
14½ " " " "	

Wood Horses on Platforms.



No. 119/2.

Made of solid wood, felt dust finish in dapple colors. Wood platform with iron wheels and tongue handles.

119/00.

Dozen.
Entire height 11 inches, length of platform 13 inches \$ 8 40

119/0.

Entire height 12 inches, length of platform 13 inches 12 00

119/1.

Entire height 13 inches, length of platform 13½ inches 14 40

119/2.

Entire height 15 inches, length of platform 16 inches 21 00

Papier-Mache Horses.

On platform with wood wheels. Well painted horses.

271/27.

Gross.
Entire height 5½ inches, ⅙ gross in package. \$ 9 60

271/28.

Dozen.
Entire height 6½ inches, 1 dozen in package 1 50

271/29.

" " 7 " 1 " " 2 20

271/30.

" " 9½ " ½ " 3 60

271/31.

" " 10½ " ½ " 4 50

Plush Horses with Carts.

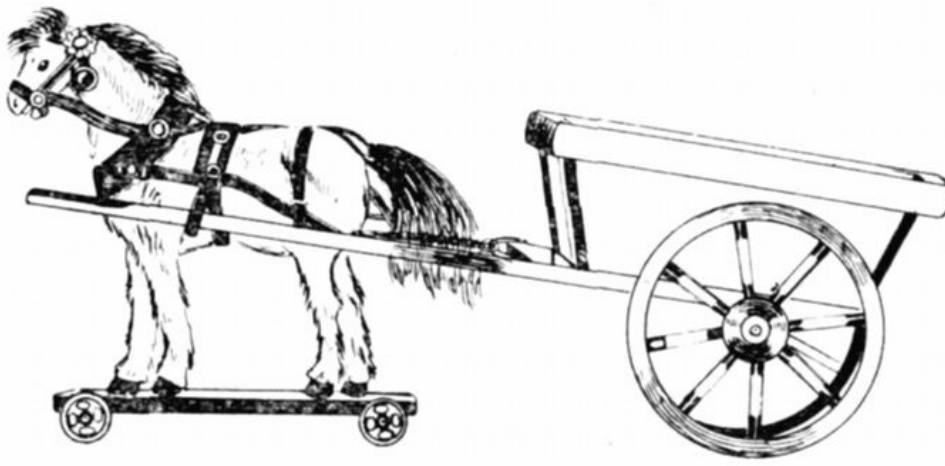

No. 156/97.

Well shaped plush platform horse with harness. Nicely varnished and fancy striped wood cart.

156/97.

156/98.

156/99.

Dozen.

Entire length, 16 inches, ½ dozen in package	\$ 8 40
" " " 20 " ⅙ "	16 00
" " " 24 " 1/12 "	24 00

Plush Horses with Loaded Trucks.

Trucks are well painted in bright colors.

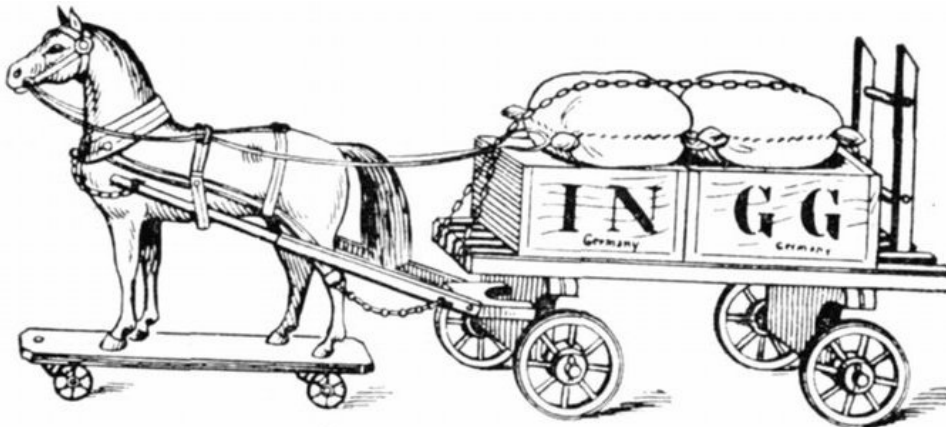

No. 269/33.

269/32.

269/33.

269/34.

269/25.

Dozen.

Length, 16 inches; loaded with 2 cases and 1 barrel	\$16 00
Length, 19 inches; loaded with 2 cases and 2 bags	26 40
Length, 27 inches; loaded with 2 cases and 4 bags	42 00
Length, 33 inches; loaded with 2 cases, 1 barrel, 3 bags	72 00

Papier-Mache Horses.

With Loaded Trucks.

Painted horses and natural wood trucks.

271/46.

271/47.

271/48.

Dozen.

Length, 17 inches;
loaded with 3 boxes, 1 bag; 2 horses \$12 00
Similar to above but is
a hay rack truck 12 00
As 271/46, but larger,
length being 21 inches 18 00

TOY CARTS.

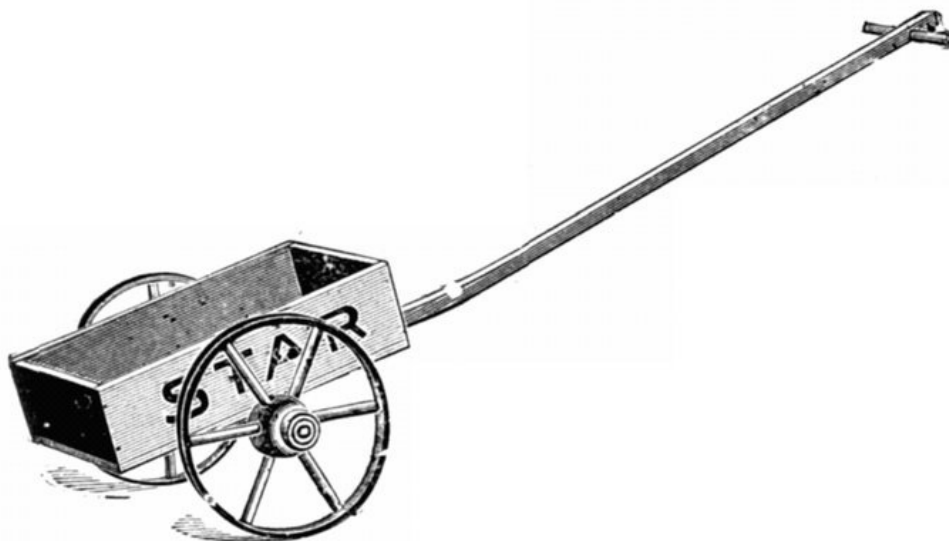

No. 2.

2.

Has 8 inch
spoke wheels,
tin tires; outside
of box painted
red, sides neatly
lettered and
varnished. Size
of body, 7 x 12
in. An extra
large and well
finished cart for
the money. (One
doz. in crate) Dozen, \$ 4 00

HAY CART.



No. 0.

0.

Dozen.

Has 5 inch spoke
wheels, wood tires; red
stained box. Size at \$ 2 80
top, 12 x 7½ inches
3½ inches deep. Set up
Knocked down,
in crates of 3 Per
dozen gross, 30 00

GALLOPING STICK HORSES.

Papier-Mache Horses with Felt Saddle Cloths. Are Nicely Painted.

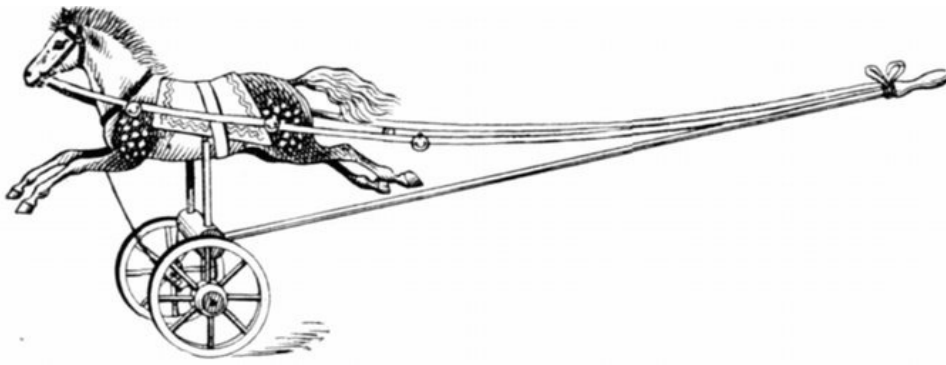

No. 271/38.

271/34.

271/35.

271/36.

271/37.

271/38.

271/39.

Dozen.

Solid wood wheels, entire length 21 inches, 1 dozen in package	\$ 1 60
Spoke wheels, entire length 28 inches, 1/2 dozen in package	3 80
" " " 32 " bsp;	4 60
" 1/2 " " " " 37 " 1/2	9 00
" " " " " " 39 " 1/4	12 00
" " " " " " 46 " 1/6	21 60

CUTS FOR SALE. We will supply to our customers, **AT COST**, duplicate electrotypes of any cuts in this Catalogue. In lots of ten or over cost averages from 30 to 40 cents each (net) according to size.

Allow about three days for having the electrotypes made, and in ordering give number of cut and Catalogue page it appears on.

Office Baskets.

Made of clear round willow, strongly woven.

ROUND.

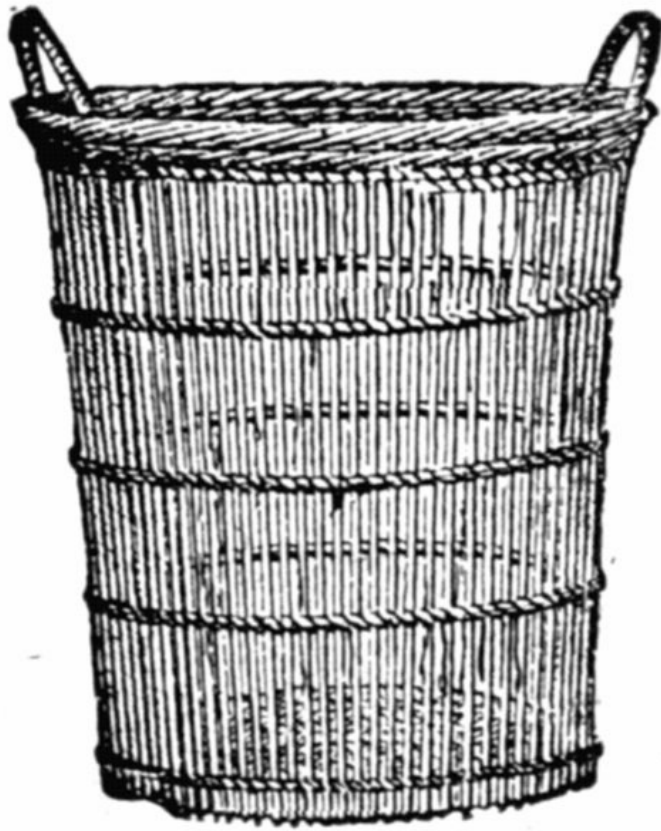

No. 1R.

00 R.
0 R.
1 R.

Dozen.

12-in high, 11-in. wide	\$ 6 50
13-in. " 12-in. "	7 20
14-in. " 13-in. "	8 40

SQUARE.



No. 0 S.

- 0 S.
- 1 S.
- 2 S.

Dozen.

12-in. high, 10-in. wide	\$ 7 50
13-in. " 11 in "	8 40
14-in. " 12-in. "	10 50

CROSSBAR.



No. 1.

- 0.
- 1.
- 2.

Dozen.

10 in. high, 13-in. wide	\$ 7 00
11½ in. " 15-in. "	8 00
12 in. " 17-in. "	10 80

Fancy Waste Paper Baskets.

Made with solid wood bottom, round willow uprights, fancy colored straw interwoven.



13/50. Assortment,

13/51. Assortment,

13/52. Assortment,

Dozen.

six styles, different shapes and variety of colored straw braiding; average height, 12 inches	\$ 8 00
similar to 13/50, but larger and finer quality	12 00
a beautiful variety of fine large and extra quality goods; six lines in the assortment	16 80

Baby Baskets.

Also suitable for Work or Counter Baskets.



Made of split willow, woven in fancy honey-comb pattern.

3606/2.

3606/4.

Split willow uprights, woven straw bands.

1111/1.

1111/2.

Extra quality split willow in honey-comb pattern.

4476/3.

4476/4.

Dozen.

Size, 16 × 13 inches	\$ 9 60
Size, 18 × 15 inches	14 40
Size, 16 × 13 inches	\$10 00
Size, 18 × 15 inches	13 00
Size, 17 × 14 inches	\$16 80
Size, 18 × 15 inches	21 60

Fibre Lunch Boxes.

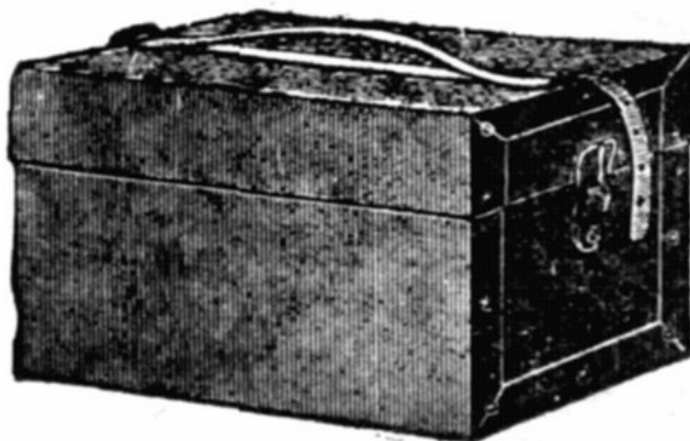

No. 7½ and 8½.

Dozen.

Size, 7½ × 5 × 4¾

7½.

inches, with strap \$3 00

8½.

Size, 8¼ × 5½ × 5 inches, with strap 3 60

Folding.

Cloth bound, tin corners; strap handle. 6 00
Size, 8 × 5 × 4½ in

DOLL CABS.



No. 1.

6851.

Dozen.

Stained wicker body, 13 inches long 6 inches wide; wicker wheels and handle \$4 00

1.

Stained wicker body, 14½ inches long, 6 inches wide; wooden wheels and handle 6 70

2.

As above, size 17 × 8 inches 8 00

3.

" " " 19½ × 9 " 12 00

5.

" " " 24 × 11 " 15 00



No. 4.

4.

Dozen.

Fancy reed body (as cut) 16 inches long; lined. Size of body 16 × 7 inches. 5-inch wheels

\$8 00



No. 16.

16.

Dozen.

Maple and reed body,
cretonne lining with
binding. Size of body \$16 80
18 × 8½ inches. 7-inch
wheels



No. 16½.

16½.

Dozen.

Maple and reed body,
cretonne lining,
upholstered and with
binding. Size of body \$24 00
18 × 8½ inches. 8 and
9-inch wheels. Steel
springs; folding parasol

DOLL GO-CARTS.

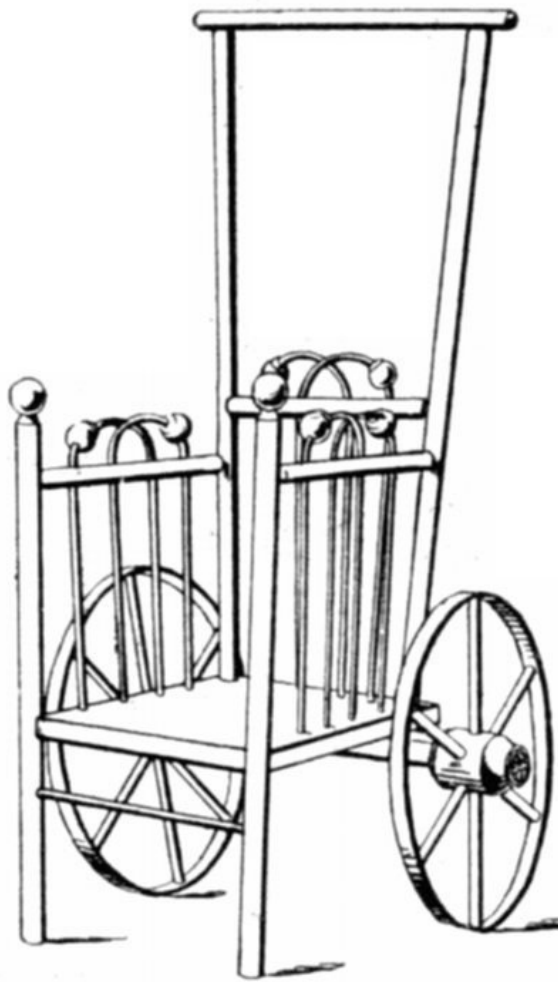

No. 3.

3.

1.

Dozen.

Has 5-inch wood wheels; reed body, natural wood finish. Size of seat 7 × 7 inches; entire height 22 inches (1 doz. in crate)

\$4 00

Similar to No. 3, but with varnish finish and has 7¼ inch wheels

5 50

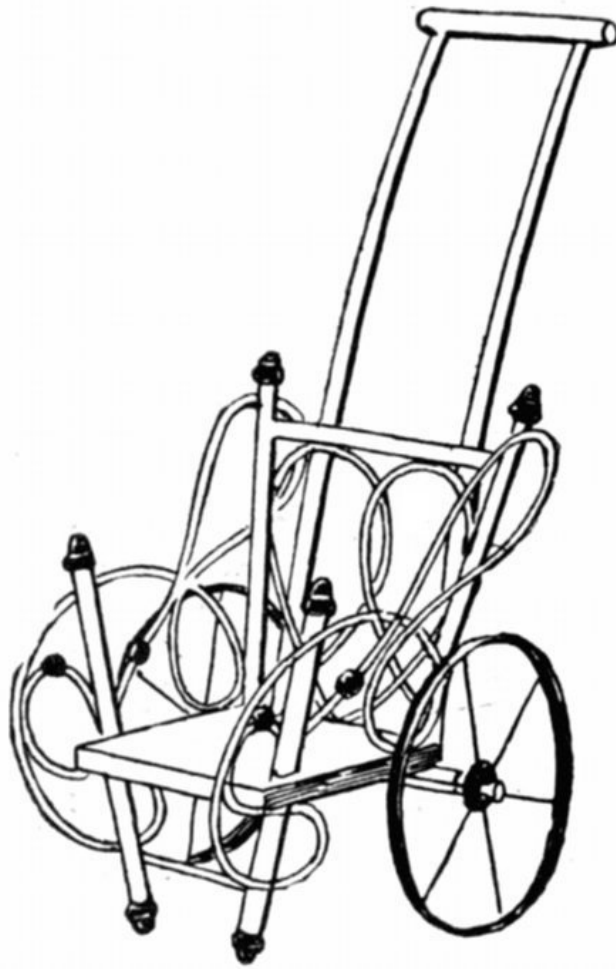

No. 250.

250.

Dozen.

As cut. Reed body,
stained knobs. Metal
wheels, tinned, 7-inch
diameter. Height of
handle, 20 inches. Size
of seat 6 × 6 inches

\$6 50



No. 251.

251.

Dozen.

As cut. Reed body. 10-inch trimmed metal rear wheels, and 5 inch wood spoke front wheels. Height of handle 22 inches. Size of seat $7 \times 7\frac{1}{2}$ inches \$14 40

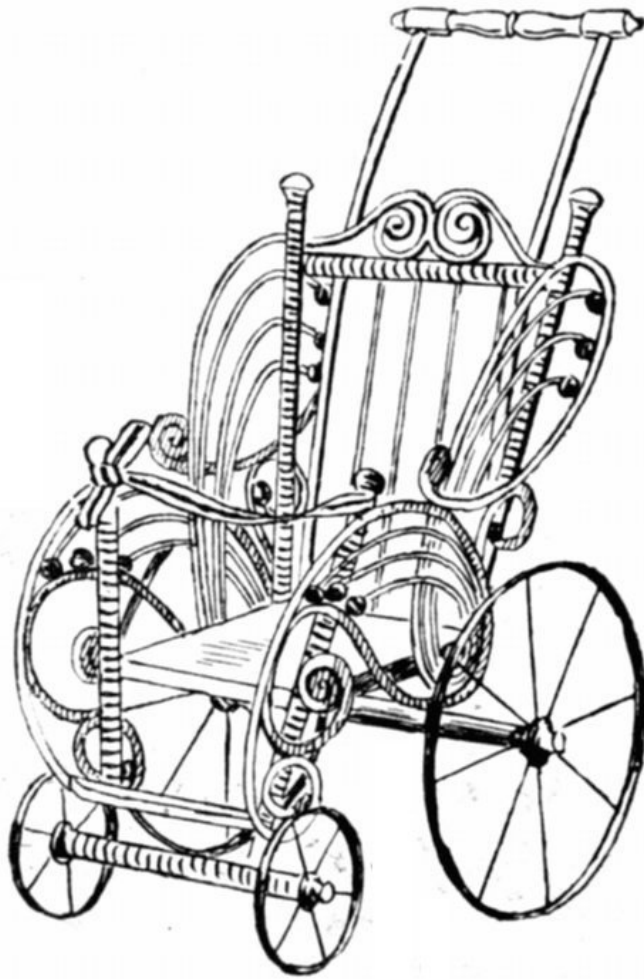

No. 253.

253.

Dozen.

As cut. Body made of selected reeds and shellacked. 11-inch tinned metal rear wheels, and 5-inch tinned metal front wheels. Height of handle 26 inches. Size of seat 8 × 8½ inches

\$26 40

256.

Dozen.

Fancy reed body, woven sides and back, shellac finished. 22-inch tinned metal rear wheels, and 5-inch tinned metal front wheels. Tinned C. springs. Height of handle 26 inches. Size of seat, 8 × 8½ inches

\$36 00

BABY SWINGS.

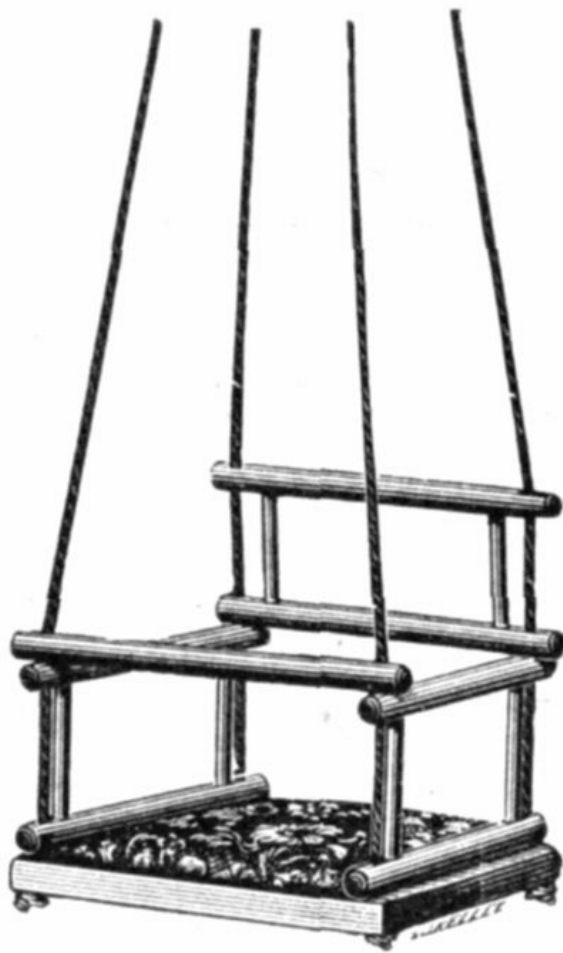

1.

3.

Dozen.

Natural wood, long cotton ropes. Seat 11 × 10½ inches, height of back 10 inches \$ 6 50

Oil finish and upholstered seat, long cotton ropes. Seat 13 × 11 inches, height of back 10 inches 13 00

"Eureka" Swing Chair.



Dozen.

A combination swing and child's swing crib. It can readily be adjusted to any position desired, and is so constructed that a child can either sit or recline without danger of falling out. Has heavy coil suspension springs and steel adjustment rods. Perforated veneer seat and back; oiled and varnished

\$48 00

TOY TRUNKS.

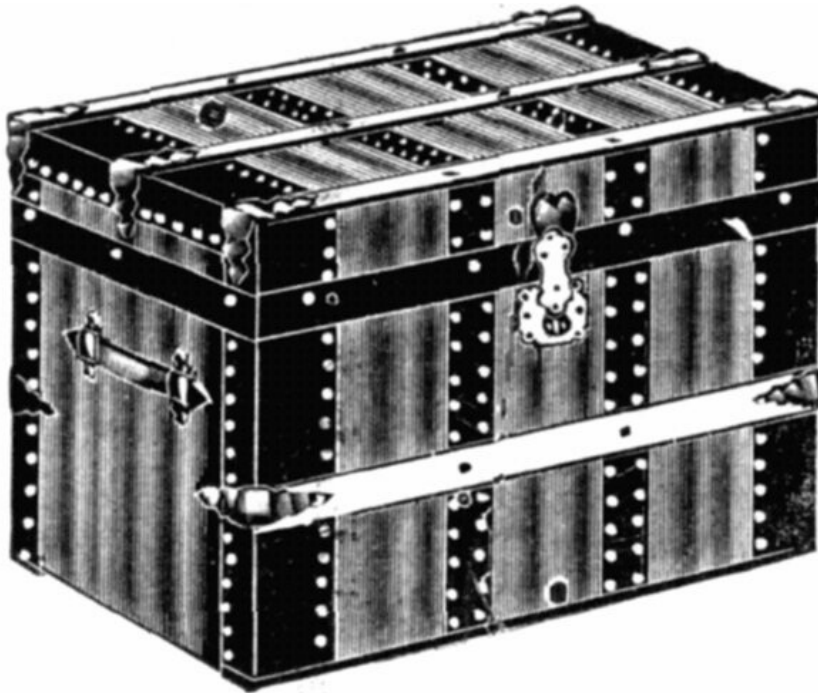

NESTED FOLIO TRUNKS.

Per Nest.

Four in Nest:

One 10 inch, one 12 inch, one 14 inch and one 16 inch. Paper covered (printed to imitate leather), good

\$ 4 00

lock, brass hinges and lock; leather handles

STEAMER TRUNK.

10-Inch Rainbow.

Dozen.

Steamer trunk. A new and striking rainbow design in enamel finish; metal back, hinges and corner pieces; leather handles

12 00

Toy Tools.

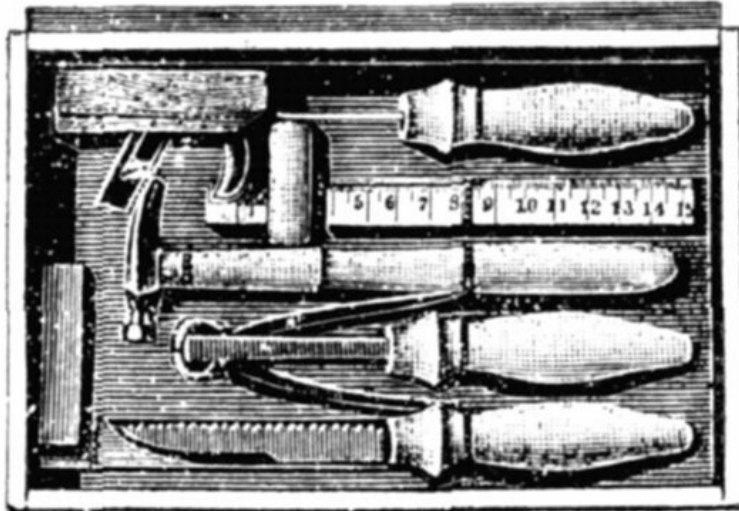

12/99.

Dozen.

Eight pieces including regular shape handsaw. Cardboard box with fancy top; size, 9¾ x 5¼ inches

\$ 3 60

12/100.

Ten pieces including a good large handsaw; polished handles. Fancy cardboard box; size, 11½ x 7¼ inches

7 20

IN HINGE COVER CHESTS.

45B.

Dozen.

Chestnut box; size, 9½ x 4¼ x 2½; hinged cover, locked corners, well finished, with brown mouldings. Contains about eleven tools

6 00

60B.

Chestnut box with till; size, 11 x 5 x 3½ inches; hinged cover with heavy brown mouldings. Contains about eleven tools

12 00

90B.

As above, but size 12¾ x 6 x 4¼ inches, and contains about thirteen tools

16 00

700B.

Chestnut box with tray; size, 15½ x 7½ x 5¾, heavy brown mouldings. Contains about sixteen tools

26 40

DOLL HOUSES.

Good representations of modern brick houses; made of wood and covered with fine lithographed paper; have glass windows, doors, etc. The whole front of the house is

also on hinges and swings out, disclosing an upper and lower room beautifully decorated all ready for furnishing.

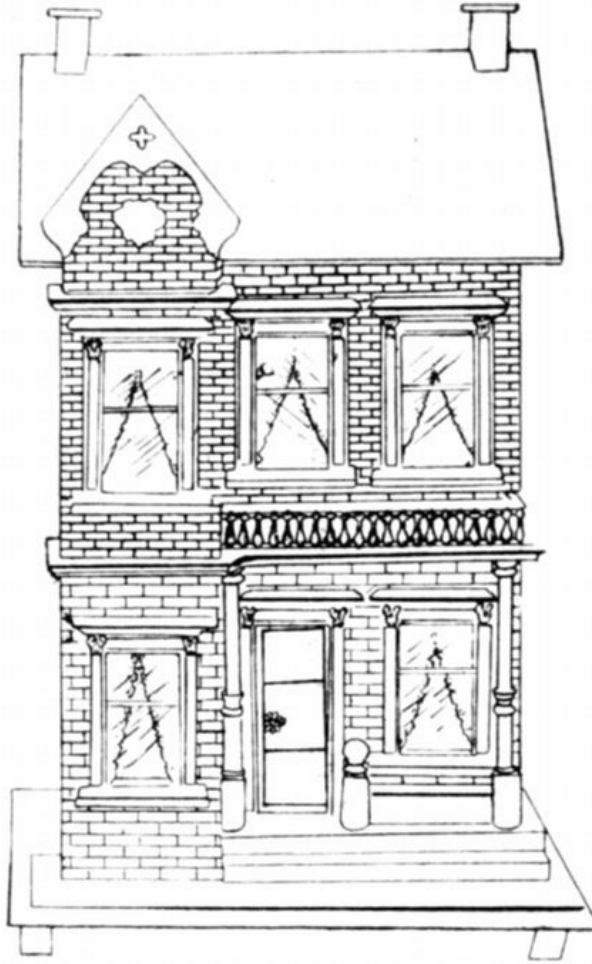

Nos. 315/24, 25, 26, 27 and 29.

- 315/33.
- 315/34.
- 315/35.
- 315/36.

Dozen.

Height 10 inches, length 6 inches	\$ 4 00
" 12 " " 7½ "	8 00
" 14 " " 8½ "	12 00
" 17 " " 10½ "	16 00

Following line are exactly as cut, extra well finished and first class in every respect.

- 315/24.
- 315/25.
- 315/26.
- 315/27.
- 315/29.

Each.

Height 14 inches, length 8 inches	\$ 2 00
" 16½ " " 10 "	3 00
" 18½ " " 11 "	4 00
" 21 " " 12 "	6 00
" 25 " " 15 "	7 50

Toy Store.



Made of wood; finely painted and decorated; very complete in every detail.

315/15. Grocery Store,

Each.

size 18 x 9 inches

\$ 2 00

TOY STABLES.



315/1.

315/2.

Finely decorated stable and driving shed, with hay mow and loft door above. Each has waggon and horses.

315/2½.

315/3.

With large dwelling room above in addition to loft. Each with waggon and horses.

315/4.

315/5.

269/30.

Dozen.

A brightly painted toy stable, 7 inches long and 6 inches high. \$ 4 00
With horse and cart. ¼ dozen in package

As above, but size 9 x 8 inches, with two horses and cart, and loft door above. ¼ dozen in package 8 00

Height 10½ in., length 11 in. \$14 40

" 11½ " " 14½ in. 21 60

Height 15 in., length 14 in. \$33 60

" 17½ " " 16½ 48 00

" 18 " " 21 " 5 50
Each

Toy Warehouse.



Have two floors, door opening into each, working hoist and load of merchandise.

315/30.

Each.

With hand truck,
height 15 in.

\$ 2 20

Toy Kitchen.

An open front apartment fitted up with tin stove and over twenty kitchen utensils, including almost every article of common use in a well equipped culinary department.

315/12.

315/13.

Each.

Length 18 inches
" 20 "

\$ 2 00

3 00

ROLLER CHIMES.

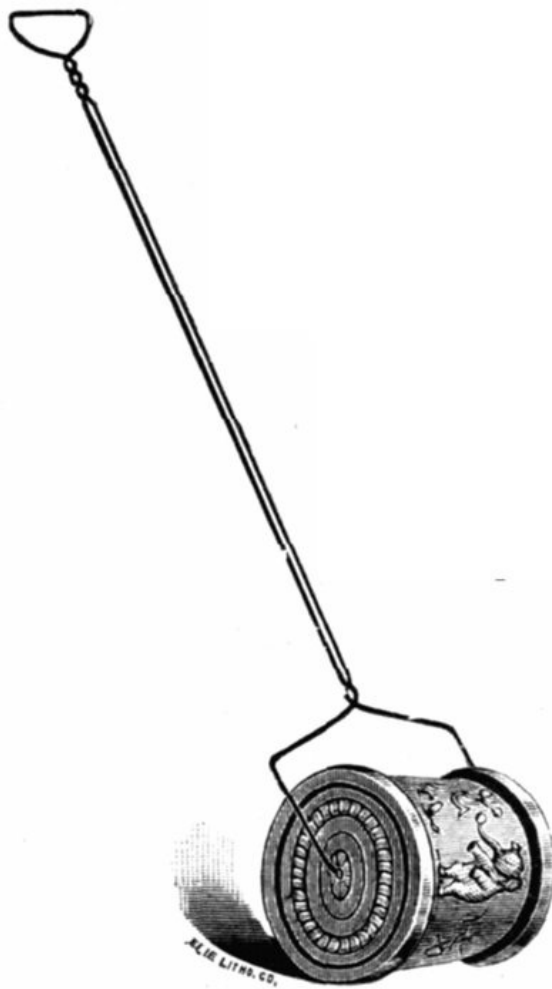

Nos. 1 and 2.

1.

2.

Dozen.

As cut. Wood wheels, handsome lithographed centre, wire handle. Has clear and perfect chime of bells. Size of roller, 4½ × 4 inches. Length of handle, 26 inches

\$ 4 80

Similar to above, but much larger. Size of roller, 6½ × 5 inches

10 80

Hobby Horse Chimes.

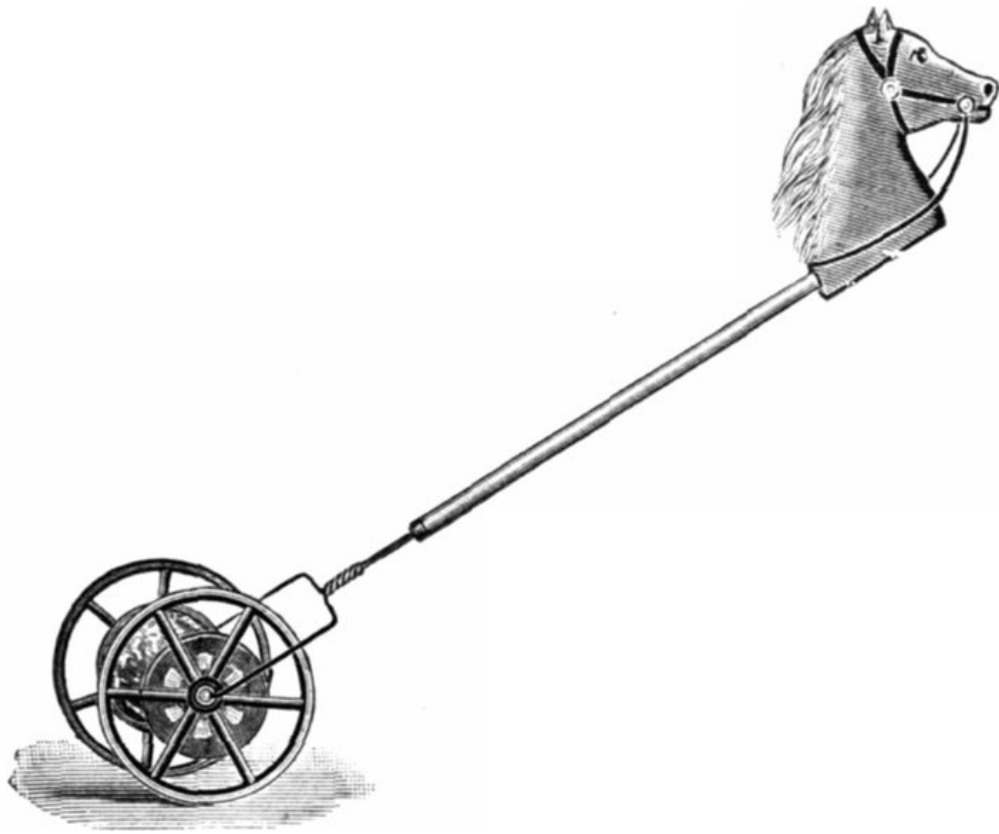

No. 10

10.

Dozen.

This is our No. 1 roller chime on spoke wheels and with a Stick Horse for handle. Diameter of \$10 50 wheels 7 inches. Length of toy over all 42 inches

Tin Floor Chimes.

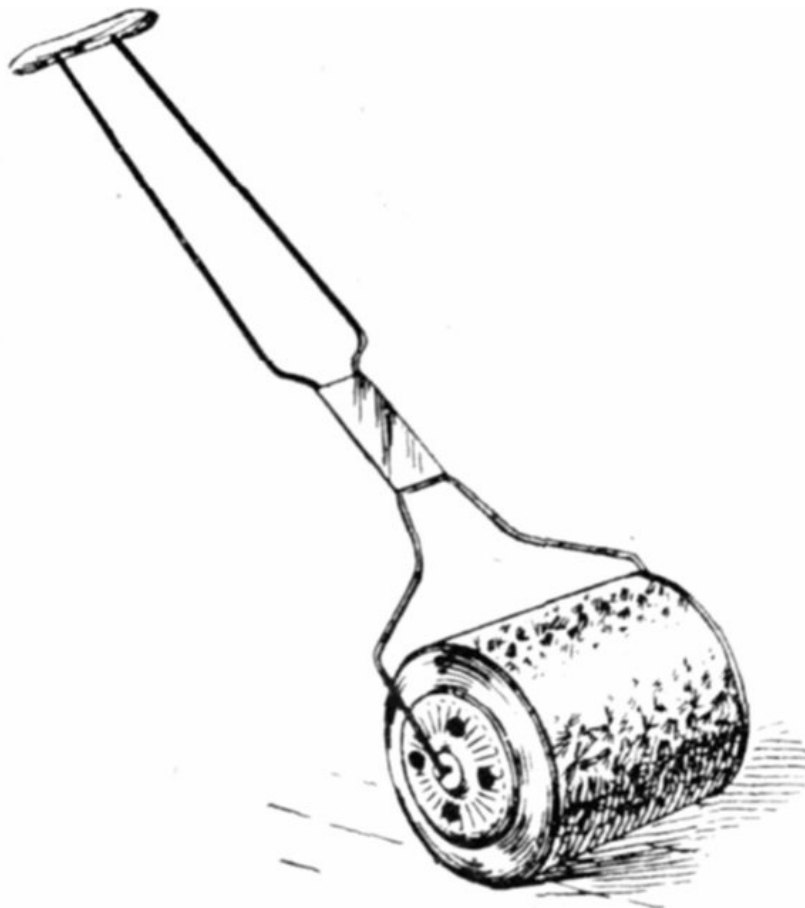

No. 19/6.

14/608.

19/6.

Dozen.

Fancy japanned roller
 box, 3 inch diameter,
 with long stick handle; \$ 1 60
 1 dozen in package
 As cut, 4 inch roller
 music box, with double
 wire handle; 1 dozen in
 package 2 50

RATTLER CHIMES.

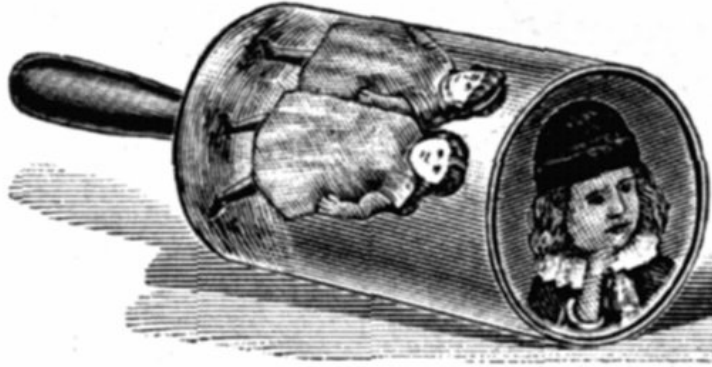

No. 0.

0.

Dozen.

Handsomely
 lithographed. This is
 the most unique
 development of the
 chime principle, and \$ 3 60
 the most attractive
 baby's rattle to be had.
 Has black enamelled
 handle. Entire length,
 6 inches

Bell Chimes.



No. 10.

Dozen.

10.

As cut. Iron wheel, two
1 3/4 inch nickel bells. \$ 2 20
Long wood handle

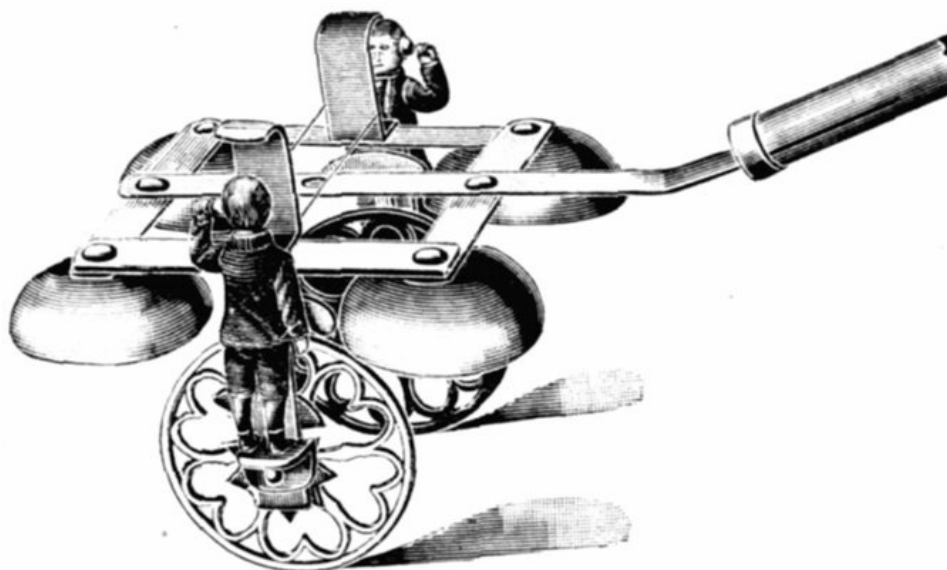

No. 40.

Dozen.

40.

As cut. Telephone
chime. Has four 1 3/4
inch nickel bells, iron \$ 6 00
wheels. Long wood
handle

Bell Chimes.

On Wheels with Cord Draw.

Dozen.

19/41.

All nickel. Has 1
medium, and 1 small
gong bell. Entire
length, 5 inches; 1/2
doz. in pkg. \$ 4 00

19/42.

All nickel. Has 2
medium, and 1 large
gong bell. Entire
length, 7 inches 8 00

19/39.

Double dome axle gong
bell with 4 1/2 inch
rubber tired bicycle
wheels 7 50

19/40.

An extra large gong
bell and 6 1/4 inch
double spoke rubber
tired bicycle wheels 19 20

TOY PIANOS.

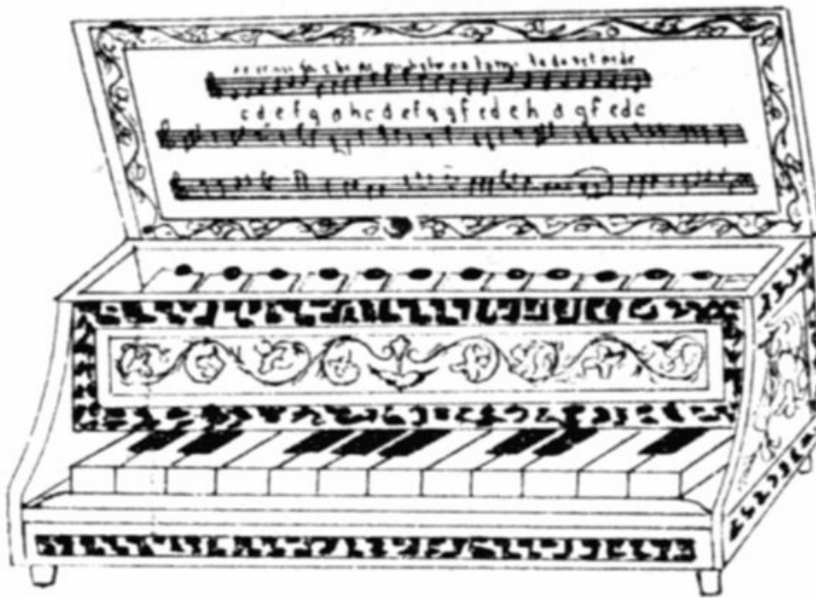

No. 332/3.

Flat Shape,

as cut. Wood bodies covered with glazed paper, gilt decoration pattern on black ground. All have sweet toned metallophone scale.

Dozen.

357/6.	Six keys. Length, 6½ inches. ⅓ dozen in package	\$ 2 50
357/8.	Eight keys. Length, 7½ inches. ⅓ dozen in package	3 20
357/10.	Ten keys. Length, 9 inches. ⅓ dozen in package	4 00
332/3.	Twelve keys. Length, 10 inches. Open top (as cut) with metallophone hammer. ⅓ dozen in package	5 50
332/4.	As 332/3 but 12-inch size. ⅓ dozen in package	7 50

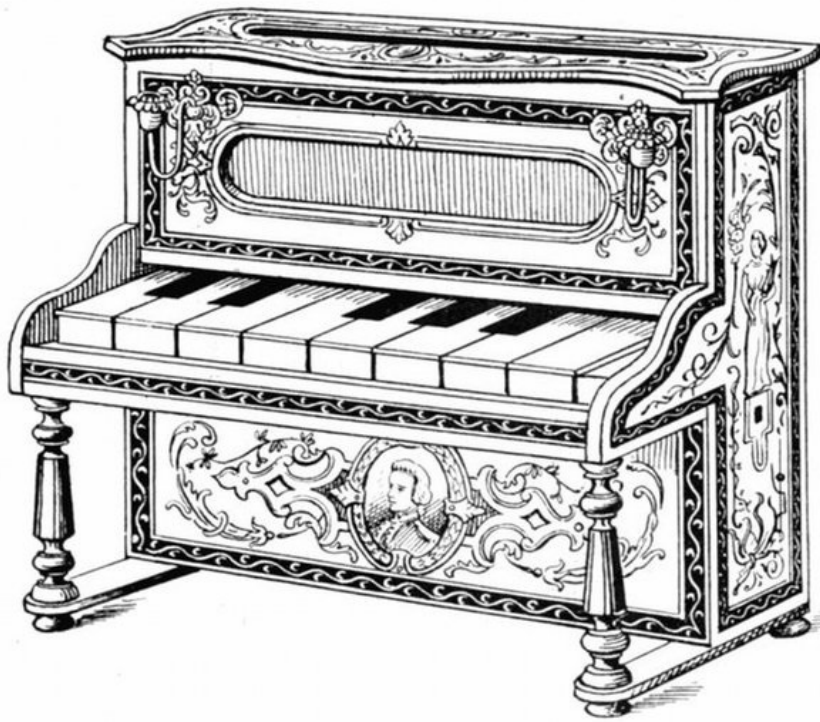

No. 332/5.

Upright Shape,

- 332/5.
- 332/6.
- 332/7.

as cut. Wood body, fancy lithograph decoration on glazed paper; all have gilt metal candle holders. Correctly tuned metallophone scale.

Dozen.

Eight keys. Length, 9 inches	\$15 50
Ten keys. Length, 11½ inches	20 80
Twelve keys. Length, 13½ inches	26 40

Toy Violins.



No. 271/43.

Each is in cardboard box complete with bridge and bow.

- 156/96.
- 271/43.
- 271/41.

Dozen.

Size, 15 × 5¼ inches	\$ 2 50
" 17 × 5¼ "	4 00
" 19 × 6 "	8 40

Blow Accordions.

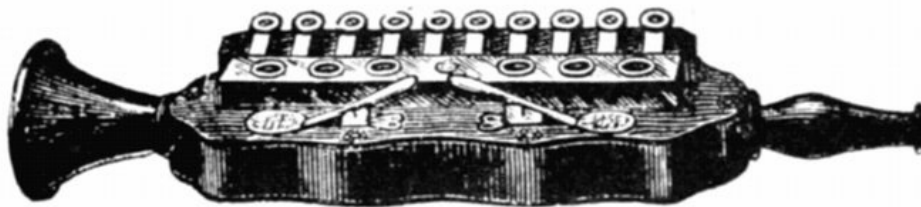

No. 98/10.

319/1.

320/2.

98/10.

Dozen.

Red polished wood, nickel reed cover. Six notes, nickel keys.	\$ 4 50
Length, 10 inches Similar to cut 98/10.	
Red polished wood, nickel reed cover.	8 00
Eight notes, two basses, bone keys.	
Length, 11½ inches As cut. Red polished wood, nickel reed cover. Ten notes, two basses, bone keys.	12 00
Length, 14 inches	

CHILDREN'S BLACKBOARDS.

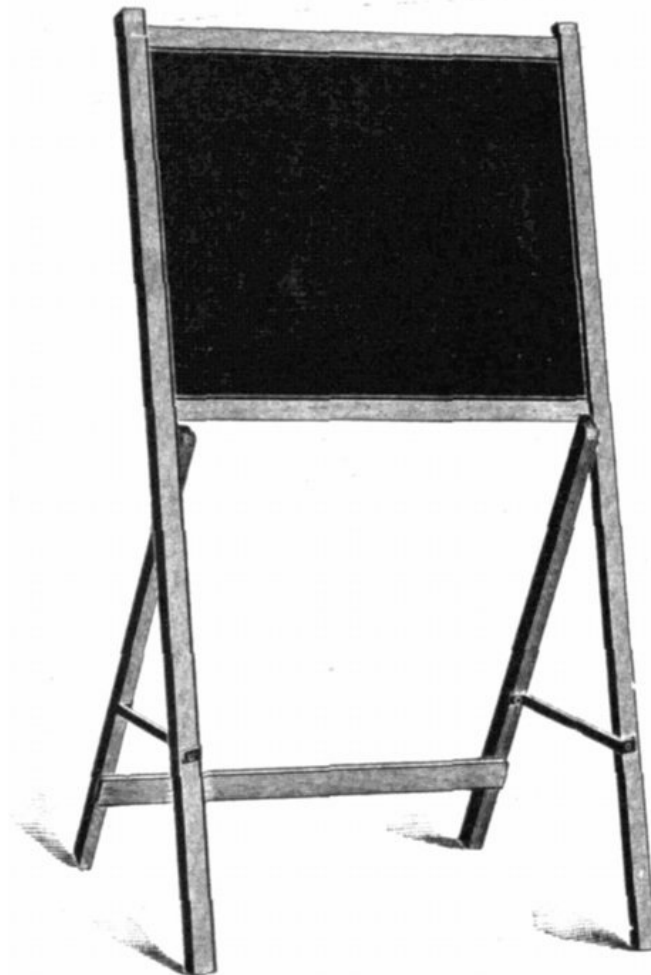

1.

Dozen.

Folding easel, oak frame; double faced; size of board, 14 × 17 inches; 1 dozen in a crate	\$ 4 00
---	---------

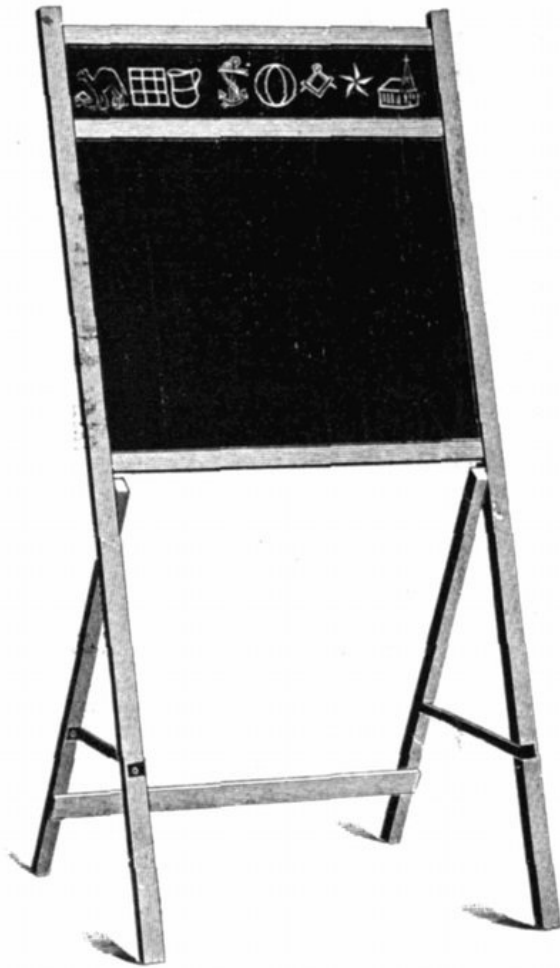

2.

Dozen.

Folding easel
whitewood frame;
double faced with
drawing designs on
each side. Size of
board 17 × 18 inches;
1 dozen in a crate

\$ 5 50

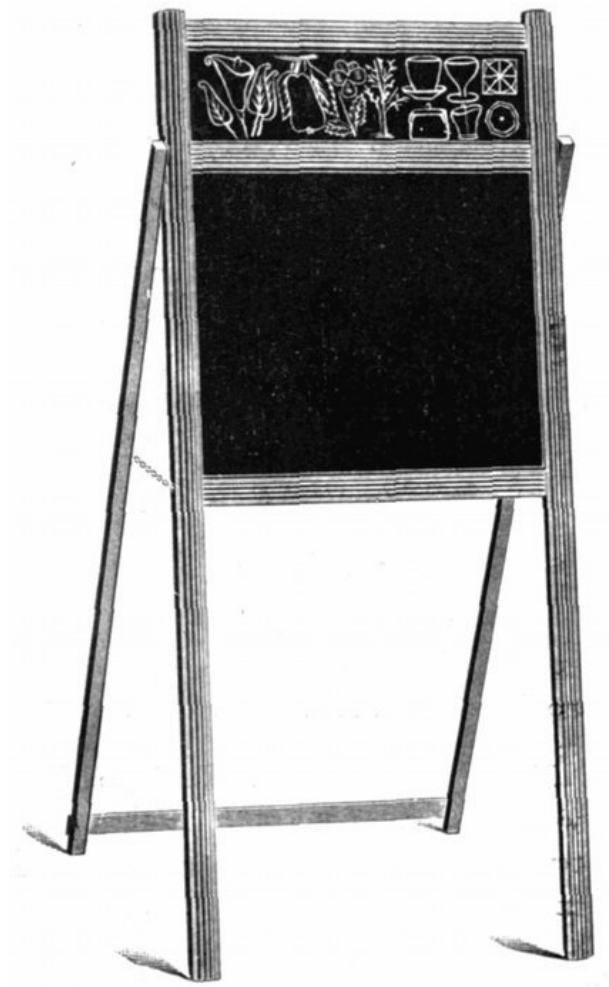

3.

Dozen.

Long support folding
easel, whitewood
frame. Double faced,
with drawing designs
on each side. Size of
board 20 × 23 inches;
1 dozen in crate \$ 8 00



5.

Dozen.

Folding easel pattern with drop table on front. Double face revolving board, with designs on both sides. Size 22 × 23 inches

\$20 00

COMBINATION DESKS WITH BLACKBOARDS.



"Ideal."

"Ideal."

Dozen.

An attractive design in a low priced combination blackboard desk. The inside is as shown in cut and the blackboard is size about 16 x 17 inches. Has rolling design chart \$18 00



"Queen."

"Queen."

A complete blackboard
with desk combination.
Made of solid oak, oil
finish; 4 feet high;
rolling chart 22 inches
by 9 feet; contains 500
letters, characters and
designs for drawing

30 00



"Chautauqua."

"Chautauqua."

Made of solid oak, nicely finished and varnished on the natural wood; elaborate carvings; rolling chart with 500 letters, characters and designs for drawing

36 00

POPULAR GAME BOARDS.

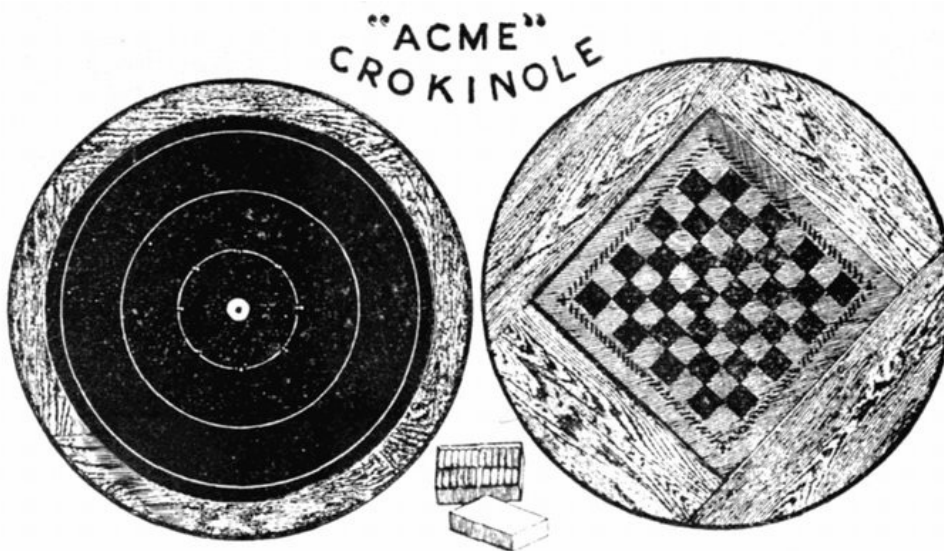

"Acme" Crokinole.

Dozen.

As cut. A finely finished round shape board with checker board on reverse side. This board while substantial and strong weighs only about one-half as much \$15 60 as the octagon shape, and thus offers a great

freight saving to the dealer. Packed four, six or fifteen boards in a crate



20. Octagon Crokinole.

Fine quality, varnish finish, with screw pegs. \$15 60
 1/2 doz. in crate

SHEBA.

The Queen of Board Games.

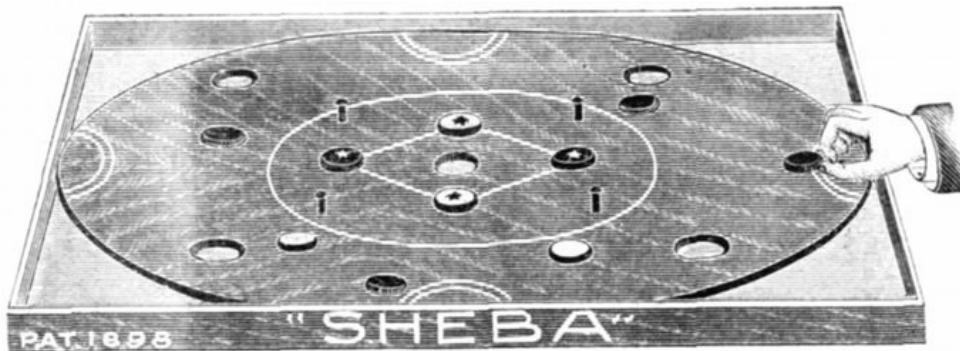

1.

2.

Dozen.

Fine quality polish, screw pegs; crated one-sixth dozen in a crate, each with fancy pasteboard box containing 24 shooting 4 "star" discs, and rules of the game \$15 60
 Same as No. 1, but has handsome lithographed checkerboard on the back, the shooting discs forming a complete set of checker men 21 60

CARROMS.

Checker Board on Reverse Side.

Bird's eye maple veneer board with felt side cushions and cloth pockets.

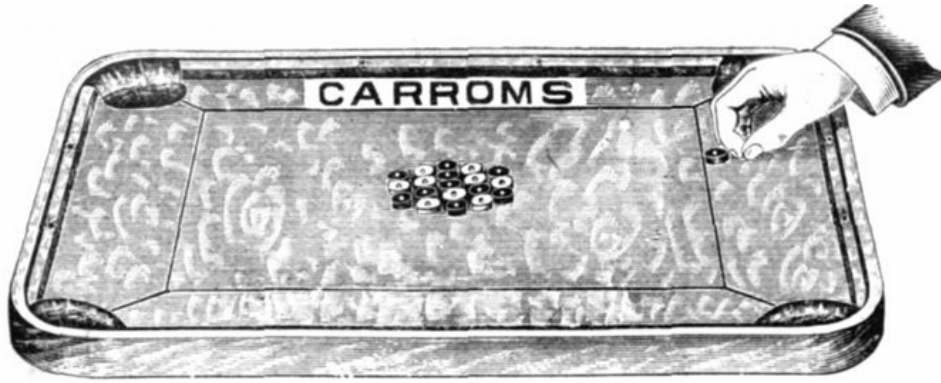

No. 1.

1.

Dozen.

A very handsome board, made of bird's eye maple veneer, which will not warp. This board will last a lifetime. Complete with rule book and shooting discs put up in fancy box (1/2 dozen in crate) \$48 00

NOTE.—Shooting discs for carroms form a complete set of checker men for playing on reverse side.

CARROMS AND CROKINOLE.

Combination—Two Great Games.

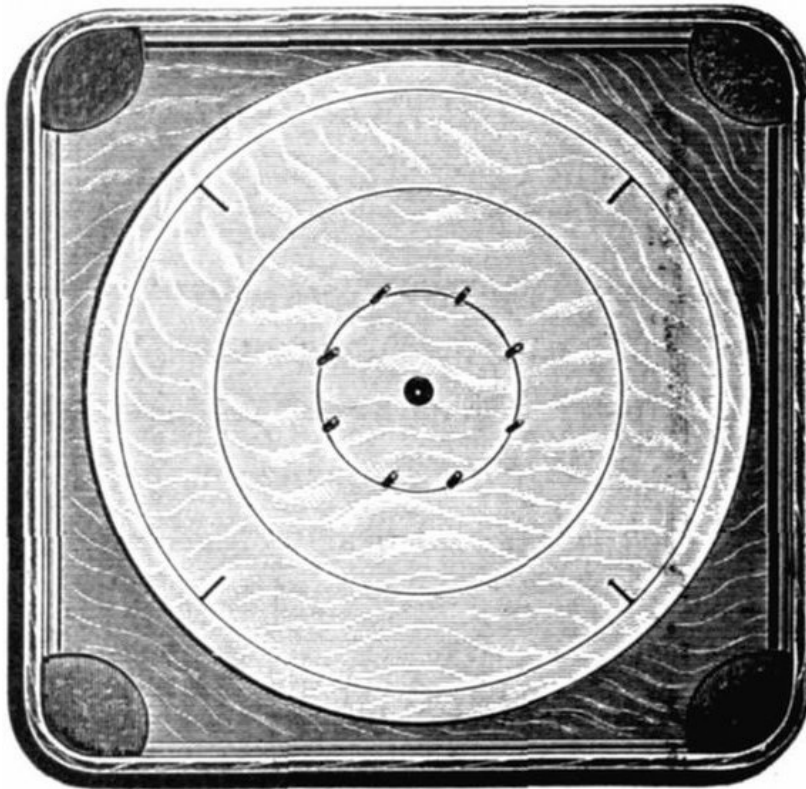

No. 1.

3.

Dozen.

An ideal combination embracing a handsome veneer carrom board with crokinole on reverse side. Discs complete for both (1/2 dozen in crate) \$48 00

BALL TOSS.



No. 479.

The accompanying cut shows a game never before manufactured in this country; similar in style to a popular foreign game, but much improved. While simple, it requires skill and accuracy of aim, making it very fascinating. Handsomely lithographed in colors and bronze. As a parlor game Ball Toss has no equal.

478.

479.

Dozen.

Ball Toss. Diameter, 13 inches; 7 holes, 2 balls	\$12 00
Ball Toss. Diameter, 20 inches; 13 holes, 4 balls	26 40

TEN-PINS.

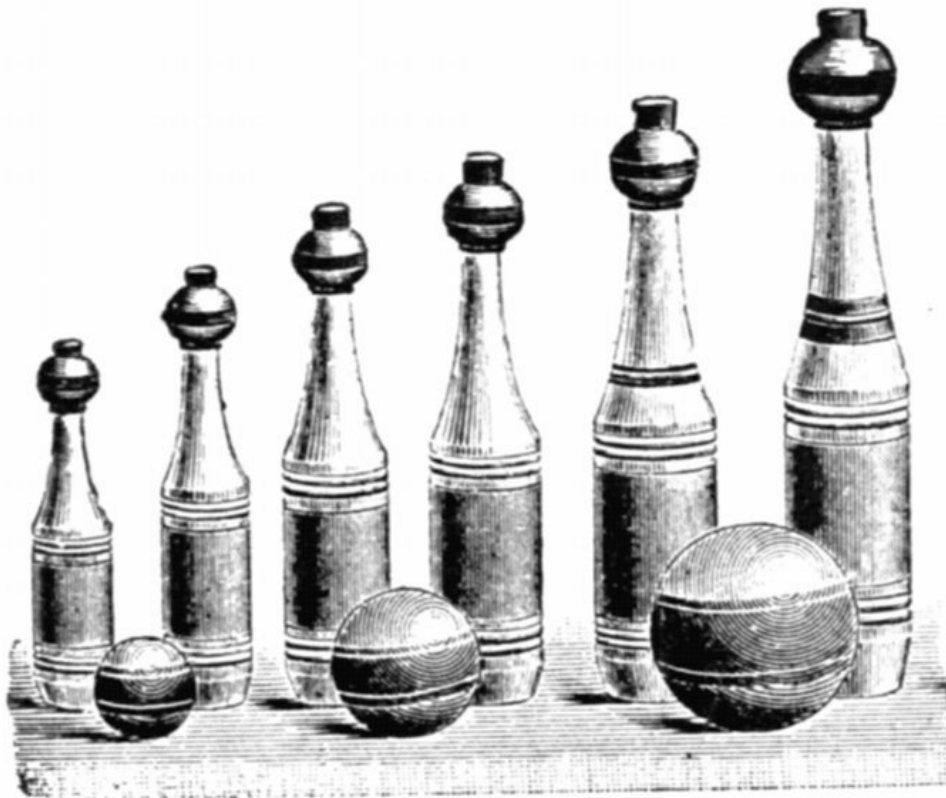

Nicely polished and striped Ten-pins, put up with balls in white wood boxes with slide covers.

6

Dozen.

-inch size, complete \$3 60

SOLITAIRE BOARDS.

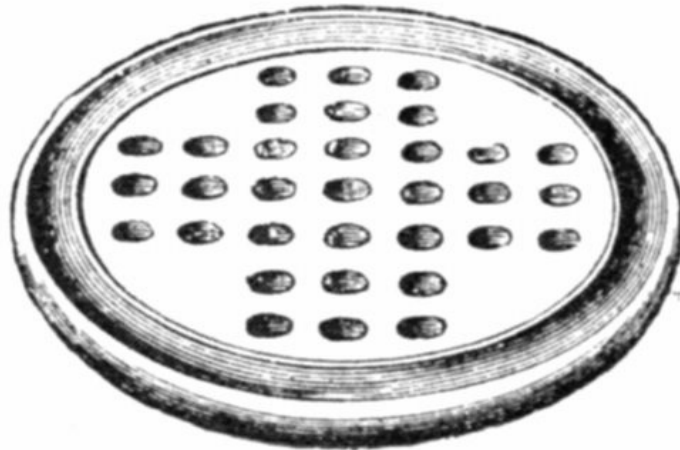

No. 12/29.

12/29.

12/98.

Dozen.

Stained board, china alleys \$4 00

Polished board, large size, china alleys 8 00

CARPET BALLS.

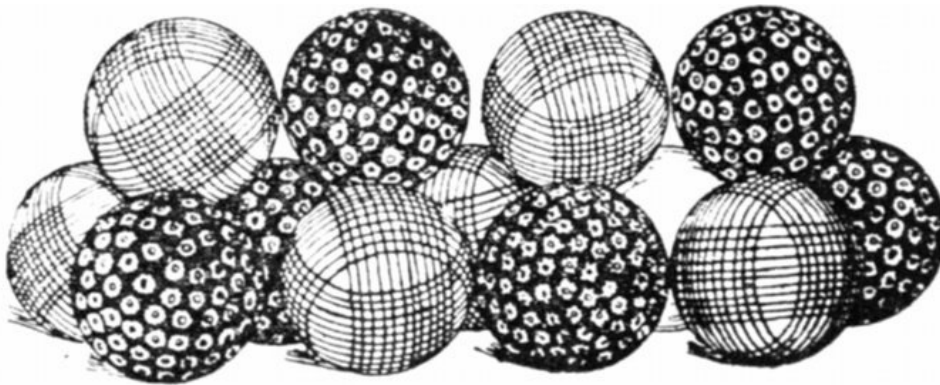

Standard set of Glazed China Balls.

Per set. \$4 00

FORT.

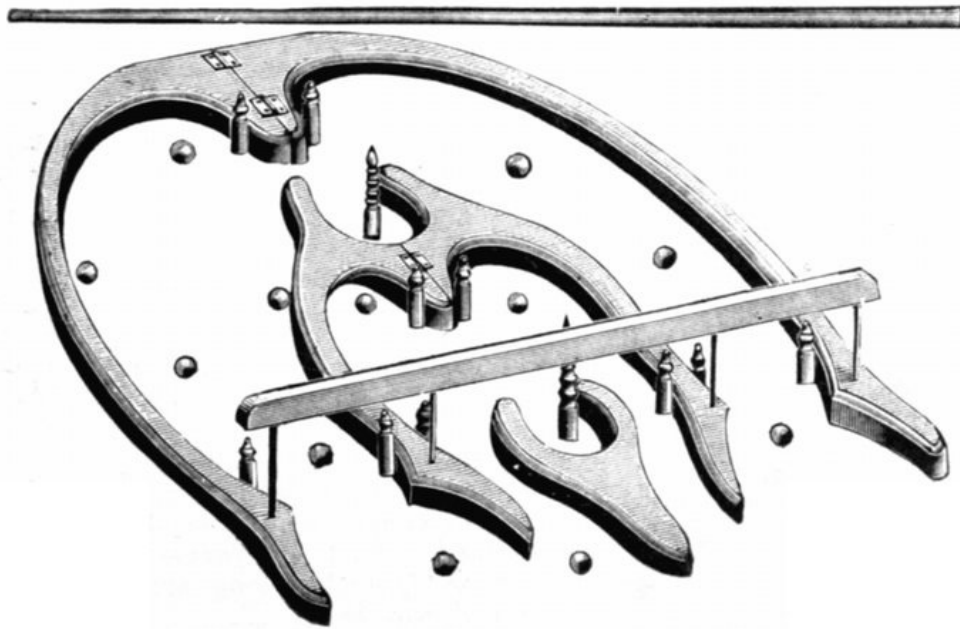

Dozen.

This popular and fascinating parlor game, made of selected stock and put up in a neat box, complete, with men, alleys and cue \$13 00

Pewter Soldiers.

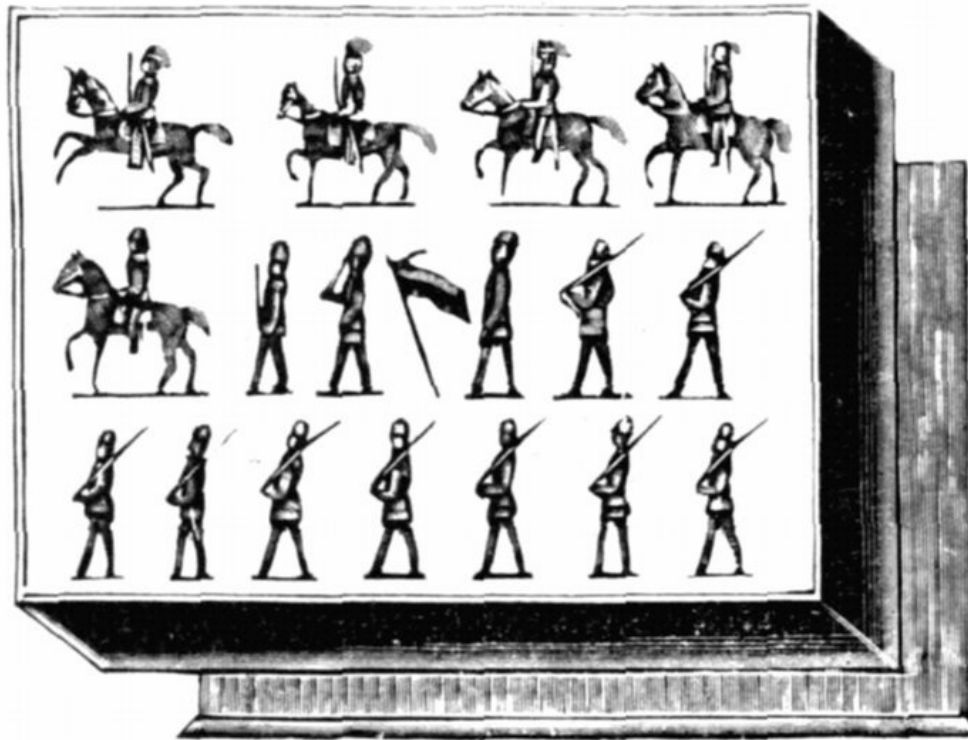

Dozen.

19/43.

Eighteen pieces
Infantry and Cavalry,
Redcoats; size of box,
8½ × 5 inches \$ 1 60

19/44.

Twelve large pieces
Infantry with band;
assorted Redcoat and
Khaki sets; size of box,
13 × 6½ inches 4 00

19/45.

Twenty large pieces
Infantry with band;
assorted Redcoat and
Khaki sets; size of box,
12 × 10½ inches 6 50

19/46.

Twenty-three large
pieces Infantry with
band and mounted
officer; assorted
Redcoat and Khaki
sets; size of box, 8 40

19/48.

15 x 12 inches
Twenty-four large pieces Infantry and Cavalry; assorted Redcoat and Khaki sets; size of box, 16 x 11 inches 12 00

19/49.

Extra quality solid figures. Twenty-four pieces Infantry and dismounting Cavalry; assorted Redcoat and Khaki sets; size of box, 17 x 10½ inches 16 80

19/50.

As 19/49 Twenty-nine pieces; size of box, 23 x 10½ inches 24 00

19/51.

As 19/49 Thirty-seven pieces; size of box, 19 x 17 inches 36 00

Strathcona Horse.

Dozen.

19/47.

All Cavalry. Assorted colored horses, Khaki riders. Eighteen pieces; size of box; 15 x 7¼ inches \$ 8 40

Paper Pulp Soldiers.



No. 209.

Indestructible, painted in lasting colors. Pieces are all large, average height being about 4 inches.

Dozen.

10K/S.

"Gentlemen in Khaki," individual soldiers 4 inches tall \$ 0 70

11H/R.

Horse and rider; height of double piece 5 inches 1 60

105.

Five pieces, including horse and rider, Khaki colored; size of box, 10½ x 5 inches 4 50

209.

Nine pieces, including horse. Khaki men, redcoat officer and rider, and pea cannon; size of box, 9 x 8½ inches 7 50
Thirteen pieces, including horse and rider, pea cannon and

212.	trees, Khaki men and redcoat officers; size of box, 12 × 8½ inches	11 50
217N.	Nineteen pieces, including mounted officers, pea cannon, trees, guard-house, etc., assorted Khaki and redcoats; size of box, 14 × 10½ in.	17 00
221.	As above. Twenty-two pieces; size of box, 14 × 14 inches	24 00
224.	As above. Twenty-four pieces; size, 16 × 14 inches	30 00
228.	As above. Twenty-seven pieces; size, 17 × 16 inches	36 00

Pewter Marine Corps.

Dozen.

19/33.	Four-inch Man-of-War Ship and 6 Marines; size of box, 9½ × 7 inches	\$ 4 00
19/34.	Three Men-of-War Ships as above and 11 Marines; size, 10½ × 10½ inches	8 00
19/35.	Three 4-inch Men-of-War and 1 larger one, 18 Marines; Size, 14 × 10½ inches	13 50

PEWTER FURNITURE.

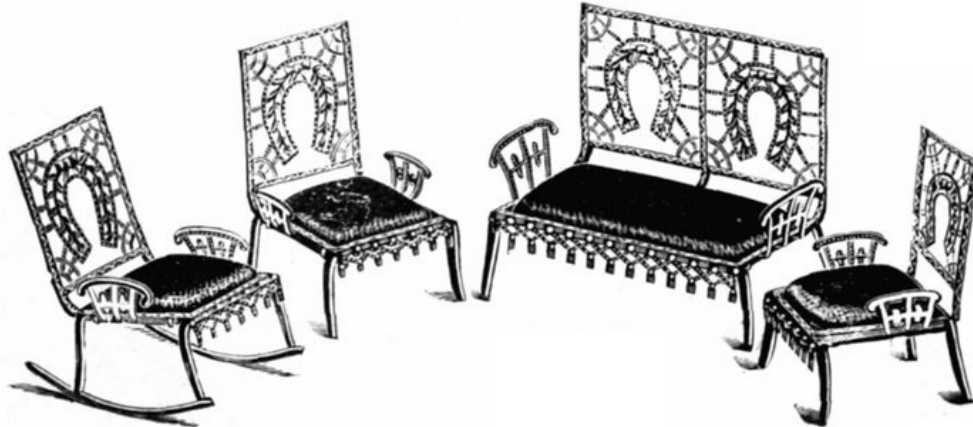

Dozen.

10.	Parlor set, comprises 3 pieces, "Horseshoe" Sofa, Chair and Rocker, each neatly upholstered in plush. The pieces stand three inches high and pack in box 6½ inches long and 3¼ inches wide	\$ 2 20
25.	Parlor set, comprises 4 pieces,—Sofa, Rocker and 2 Chairs, elegantly upholstered in plush. Each set packed in box; 9¼ inches long and 4 inches wide	4 00

PEWTER TOYS.

Tea Sets.

Very substantial and attractive, and at exceptionally low prices.



No. 10M.

10M.

15.

Dozen Sets.

Contains 22 pieces in box; size 6⁷/₈ × 4⁷/₈ inches \$ 1 70

Contains 28 pieces in box; size, 9¹/₂ × 7 inches 4 00



No. 27.

27.

Dozen Sets.

Contains 23 pieces in box; size, 11 × 9 inches \$ 7 20



No. 75.

75.

600.

Dozen Sets.

Contains 22 pieces in box; size, 14½ × 10 inches \$12 50

Contains 23 pieces in box; size, 17 × 10¾ inches 16 80

Cruet.



Dozen.

Has four glass bottles;

35.

height 6 inches, width \$ 4 00
3¼ inches; detachable
parts; each in a box

Doll Cabs.



No. 10.

10.

Dozen.

Height 5¾ inches,
length 5⅞ inches, each \$ 1 80
in a box

25.

Height 7¼ inches,
length 6½ inches, each 4 00
in box

Canary Whistle.

185.

Dozen.

Bright finish pewter
water whistle in shape
of canary, and it gives
a proper imitation of \$8 60
this bird. Size, 3½ × 2
inches

SHEET STEEL TOYS.

INDESTRUCTIBLE.

Coal or Express Waggon.

58.

Dozen.

As cut. 14½ inches
over all. Body,
7½ × 3½ inches; one
walking horse 6 inches
high; steel wheels
fastened to axles with
the new Long Arm
Hub, which adds \$ 6 00
greatly to their
durability Body painted
bright red, horse
aluminum bronze, seat

in gold, and wheels
bright yellow. ½ dozen
in box

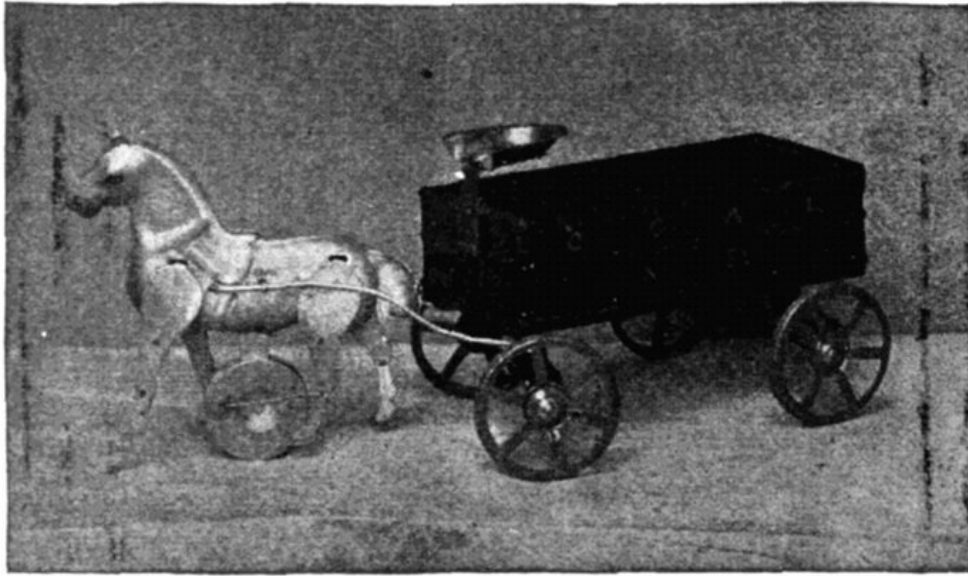

No. 58. Entire length, 14½ inches.

Coal Waggon.



No. 859. Entire length, 17½ inches.

859.

Dozen.

As cut. 17½ inches
over all. Body, 9 × 4½
inches and stands 6½
inches high; one
walking horse, 7½
inches tall. Waggon is \$12 00
in assorted bright
colors, wheels in
yellow, horse in
aluminum bronze. ½
dozen in box

EXTRA LARGE AND SHOWY.

Dump Carts.

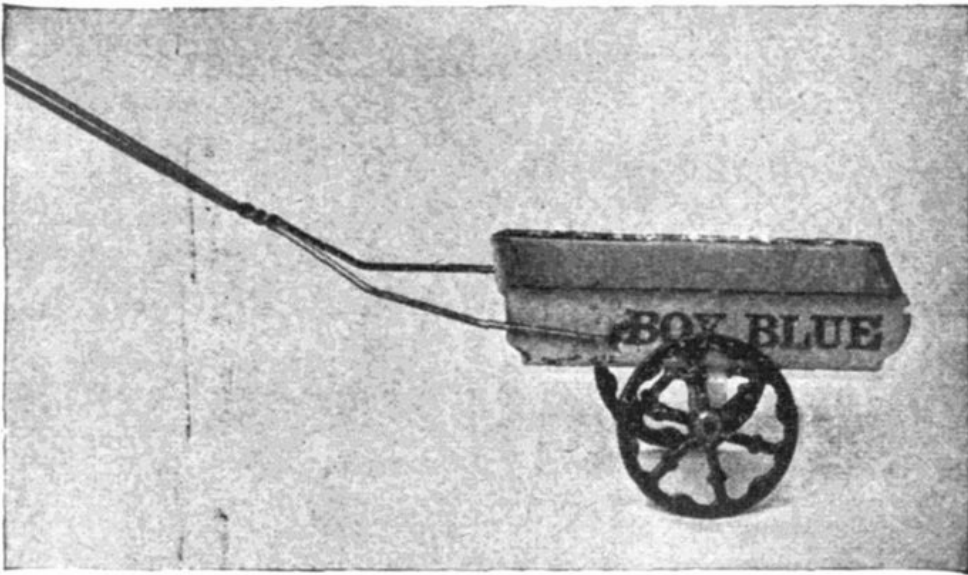

No. 52. Size of box, 7 x 4 inches.

52.

1.

Dozen.

"**Boy Blue**" is made wholly of steel, finished in two bright colors. Has long handle made of heavy wire. Size of box, 7 x 4 inches

\$ 2 40

"**Tom Thumb**," every part is of steel and is so strongly made that it is practically indestructible. Body is of one piece and is set on wood axle; wheels are fastened by bolts. Size of box, 10½ inches long; 7-inch wheels. Perfect dumping apparatus

\$ 5 50

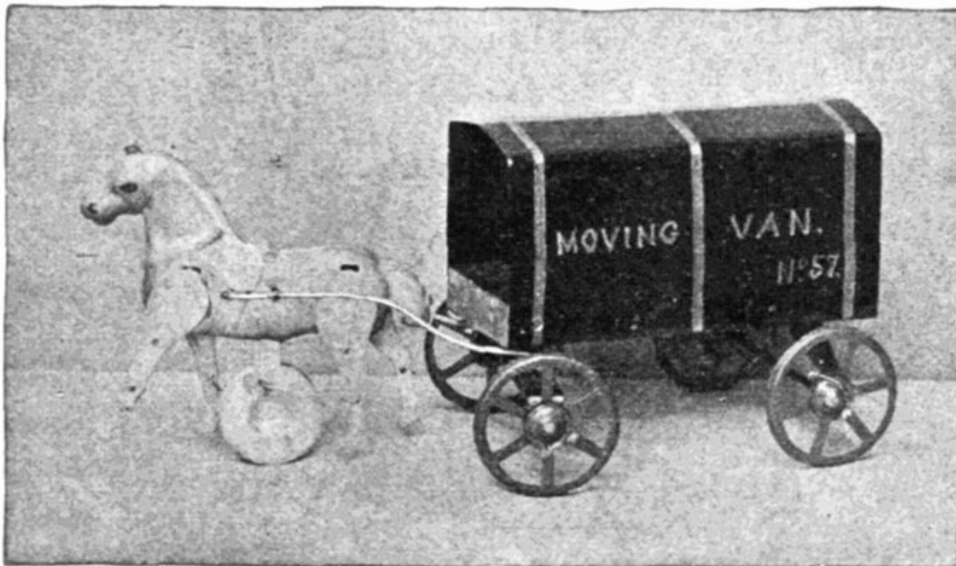

No. 57. Entire length, 14 inches.

Moving Vans.

57.

Dozen.

As cut. 14 inches over all. Body, 7 x ¾ inches, and stands 6 inches high; one walking horse 6 inches high, wheels fastened to axle with the new Long Arm Hubs. The van is painted in bright

\$ 6 00

colors, and horse is in aluminum bronze. 1/2 dozen in box



No. 858. Entire length, 17 1/2 inches.

858.

Dozen.

As cut. 17 1/2 inches over all. Body, 9 x 4 1/2 inches and stands 7 1/2 inches high. One walking horse 7 1/2 inches tall. Van is painted in bright colors, lettered in bronze, and wheels are yellow; horse aluminum bronze. 1/6 dozen in box

\$12 00

Express Waggon.

61.

Dozen.

As cut. 17 inches over all, stands 7 inches high; 1 walking horse 6 1/2 inches high. Waggon is painted in bright colors; wheels in yellow and horse aluminum bronze

\$13 00

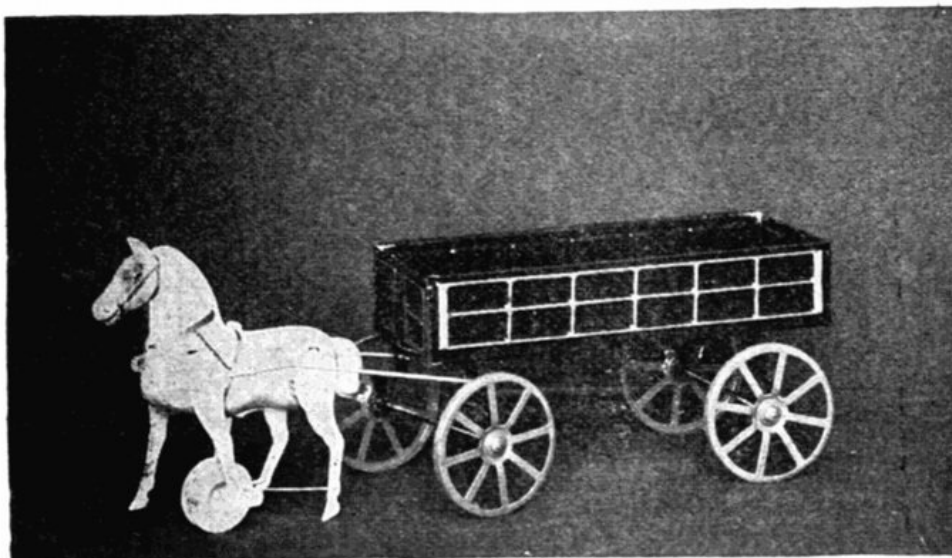

No. 61. Entire length, 17 inches.

Moving Van.

Dozen.

As cut. 20 inches over all, stands 9 1/2 inches high; 2 walking horses

788.

7½ inches high. Van is \$26 40
in bright colors; wheels
in yellow and horses
aluminum bronze



No. 788. Entire length, 20 inches.

Tally-Ho Coach.

Dozen.

776.

As cut. 20 inches over
all, stands 8 inches
high; 2 walking horses
7½ inches high; coach
comes painted in \$26 40
bright colors, wheels
yellow, horses
aluminum bronze



No. 776. Entire length, 20 inches.

All Steel Safes.

Dozen.

1.

As cut. Size, 12 × 9 by
6½ inches outside;
inside opening
6¾ × 5¾ inches;
double walled with
pigeon holes and space
for books; double door
flanged; combination
lock on two figures.
This safe is an absolute \$28 00
copy of the genuine
article, and is the only
safe which has ever
looked like a safe when
opened, and is by far
the largest ever
offered. The finish is
superb, aluminum with

2.

red and gold
ornamentation
Is same as No. 1,
except much larger
and contains additional
features. Size, \$42 00
14 × 10½ by 8 inches
outside; opening
8¾ × 6¾ inches

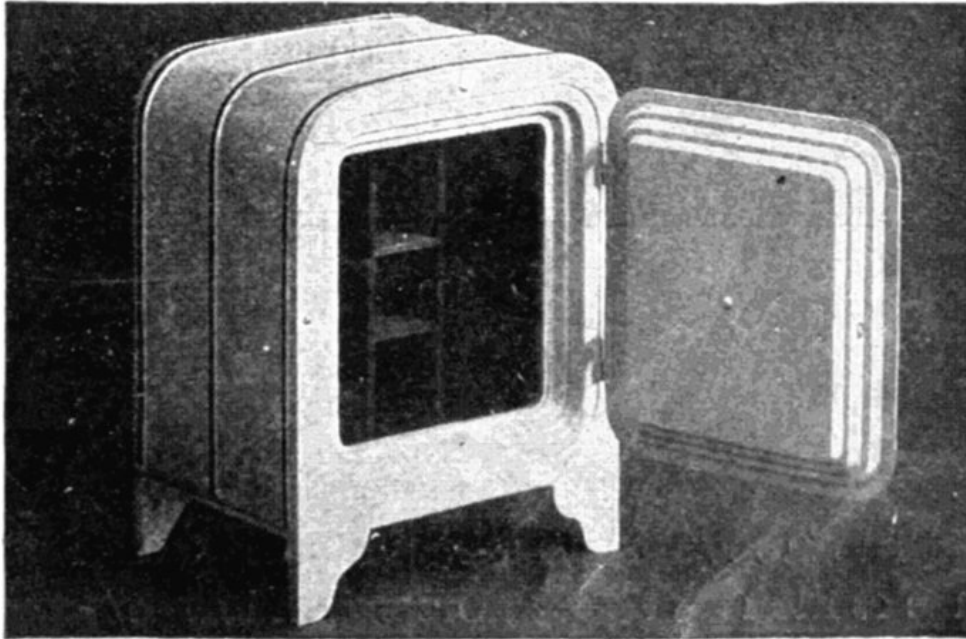

No. 1. Size, 12 × 9 × 6½ inches.

SHEET STEEL TRAINS.

STRONG AND DURABLE. EXTRA LARGE AND SHOWY.

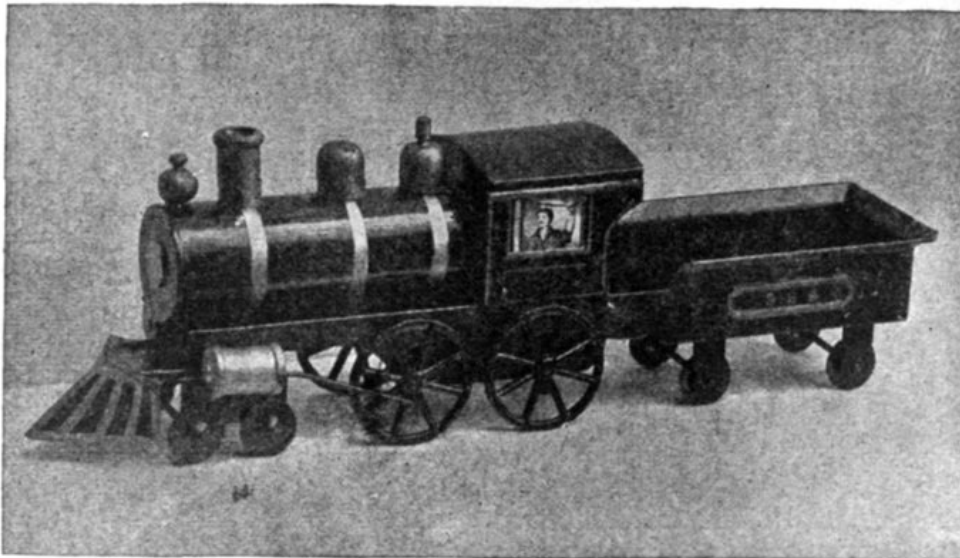

No. 888. Entire length 18½ inches.

Dozen.

As cut. Body is made of
good quality sheet
steel, and finished in
black and gilt. Wheels
are malleable iron and

888. Locomotive with Tender.

painted red. The smoke stack, dome, whistle, headlight and cylinders are gilt bronze. Length 18½ inches; height, 6 inches

Consists of 888 locomotive with tender, flat car and vestibuled coach. The two steel cars in this train fold one within the other, thus taking up small shipping space. Entire length of train, 4 feet 2 inches; height, 6 inches

888. Train Complete.

26 00

999. Locomotive with Tender.

Similar to our No. 888, but more complete in detail and much larger. Length, 30 inches; height, 8 inches

28 80

Consists of 999 locomotive with tender, flat car and vestibuled coach in size to match. Finely modelled and decorated. The cars in this train fold and pack one within the other for shipping same as No. 888. Entire length, 6 feet 3 inches; height, 8 inches

999. Train Complete.

56 80

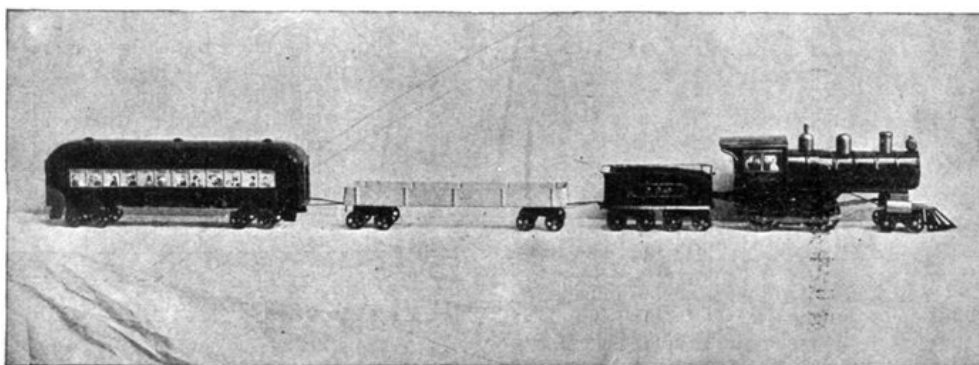

No. 999. Steel Train complete, 6 feet 3 inches long and 8 inches high.

As a Window Piece.

The above trains, being so large in size, and attractive in design and coloring, form an excellent subject for a window piece or inside display attraction; and so exhibited create for themselves a ready sale.

BOYS' SOLDIER SETS.

Each set is put up on fancy Flag Card, and all are so attractively gotten up that they are sure to be big sellers at this time of so much military enthusiasm.

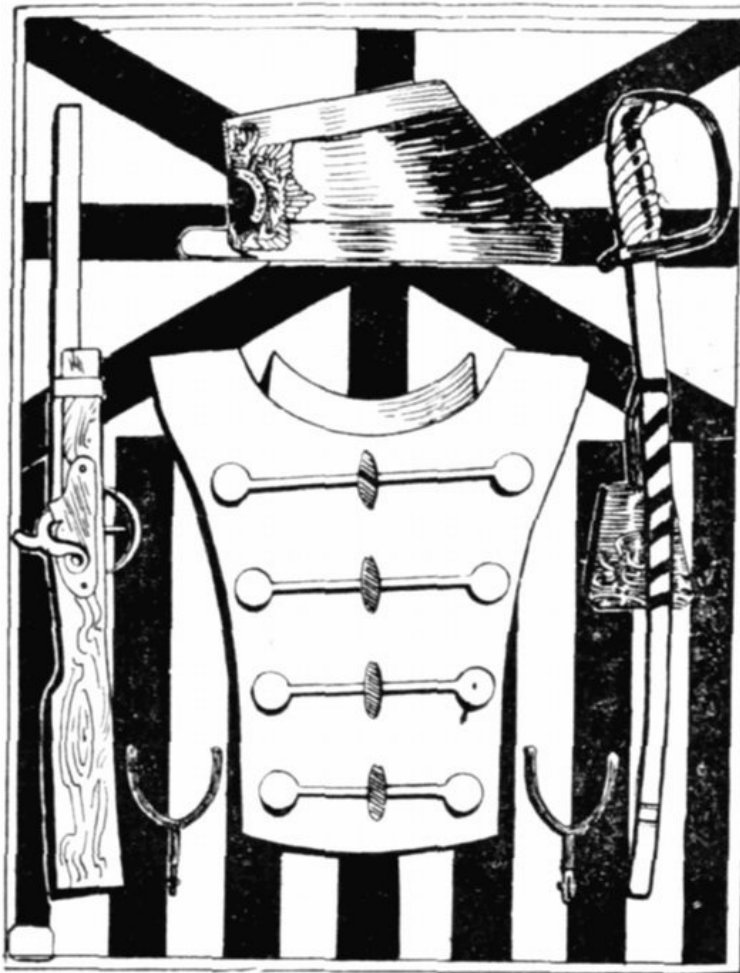

No. 4.

Dozen Sets.

1.	<p>Infantry. Cap, red breastplate with gilt epaulets and sword. Size of card, 19½ × 12½ inches</p>	\$ 6 00
2.	<p>Infantry. Cap, knapsack, epaulets and sword. Size of card, 19½ × 12½ inches</p>	6 00
3.	<p>As No. 2, but has in addition a gun that will explode paper caps. Size of card, 20 × 17 inches</p>	8 00
4.	<p>Cavalry. As cut. Cap, red breastplate, spurs, sword and gun that will explode paper caps. Size of card, 25 × 18½ inches</p>	8 40
14.	<p>As No. 4, but Khaki colored cap and breastplate</p>	8 00

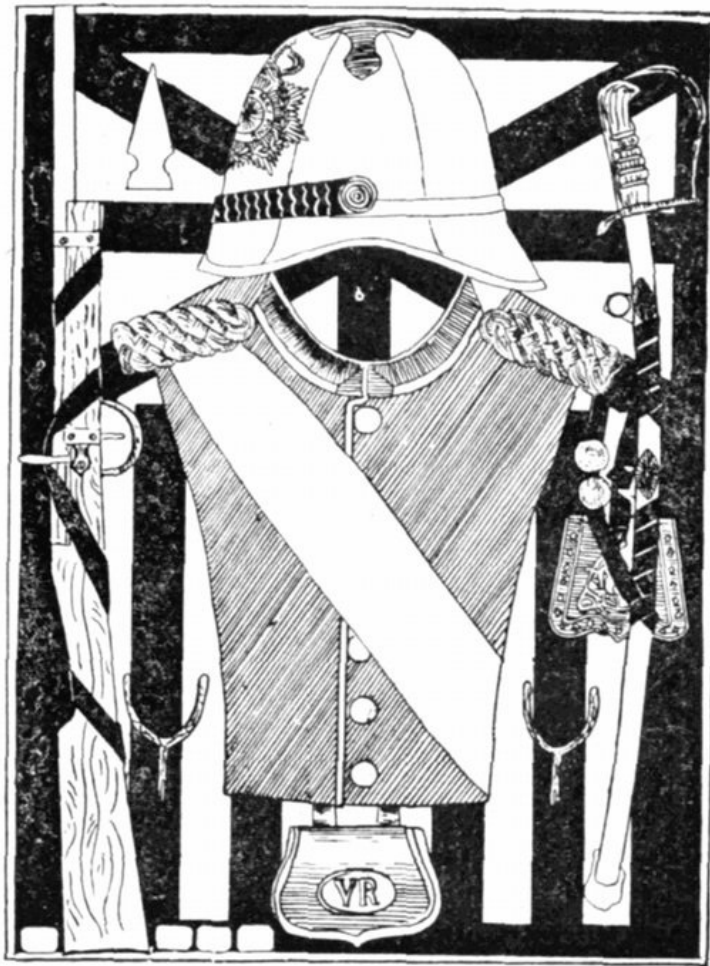

No 9.

Dozen Sets.

5.	<p>Infantry. Helmet with spike, red breastplate, good sword and gun. \$13 00 Size of card, 25 × 18½ inches</p>
8.	<p>Cavalry. Helmet with hair plume, blue breastplate, sword, spurs, belt of dummy cartridges and spring gun to shoot them. Size of card, 25 × 18½ inches 16 80</p>
9.	<p>Infantry Officer. As cut. Helmet with spike, breastplate, despatch pouch, spurs, sword, and gun that explodes caps and shoots stick 16 80</p>
11.	<p>Royal Canadian Dragoon Uniform. Fine helmet with chain, breastplate, knapsack, cartridge pouch, gilt epaulets, spurs, good sword, and gun that shoots caps and stick 24 00</p>
12.	<p>Dragoon Guard Uniform. Gilt helmet with plume, breastplate, despatch pouch, cuffs and sword 30 00</p>
13.	<p>Hussar Officer. Black fur head gear with white flap and gold trimmed, plume, breastplate, shoulder strap and pouch, epaulets, cuffs, spurs, sword, and gun to shoot caps and sticks 42 00</p>

"Strathcona Horse" Sets.

Dozen Sets.

15.

"Strathcona Horse" Uniform. Consists of Khaki hat, breastplate, spurs, sword, and gun that explodes caps. Size of card, 25 × 18½ inches \$13 00

16.

"Strathcona Horse" Uniform, same as No. 15, but has belt full of dummy cartridges, and spring gun for shooting them 16 80

Fireman Set.

6.

Consists of large red helmet, canvas belt with leather straps and large wooden axe \$13 50

IRON TOYS.



No. L108.

L108.

Dozen.

Sulky and horse, with driver; nickel and painted. Length, 5 inches. 1 dozen in package \$1 40

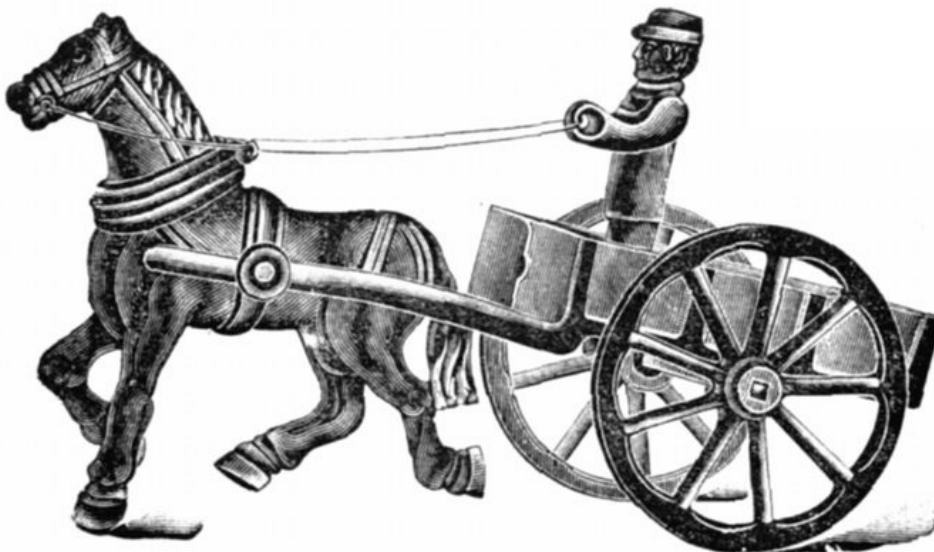

No. 15½.

15½. Cart,

Dozen.

with horse and driver; painted. Length, 6 inches. 1 dozen in package \$2 40
pony and driver;

M5. Pony Cart,

2 80
painted. Length, 7 inches. 1 dozen in package
in swan chariot; painted. Length, 7 inches. ½ doz. in package

8. May Queen,

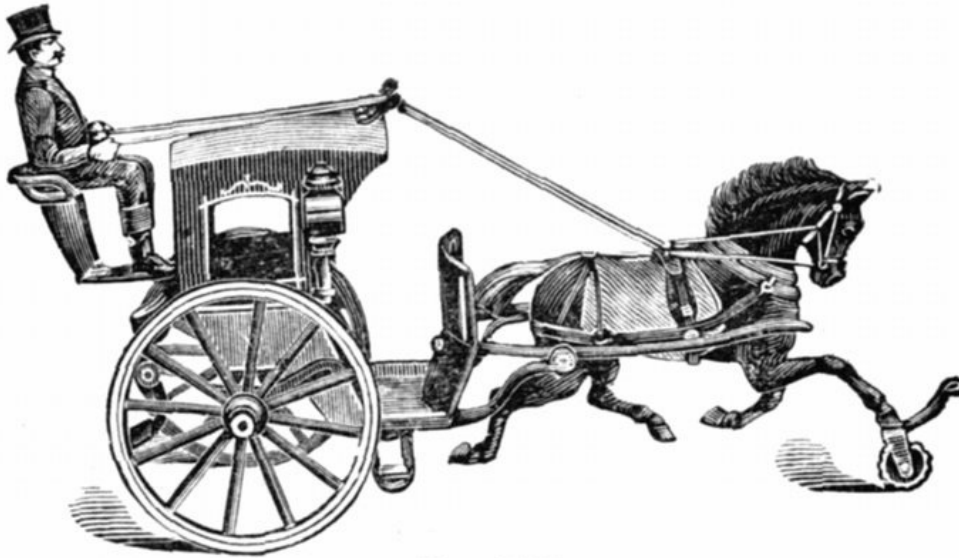

No. M65.

Dozen.

M65. Handsome Cab,

with horse painted. Length, 7½ inches. ½ \$4 00
doz. in package



No. 567.

Dozen.

567. Buggy,

with horse and driver; painted. Length, 8½ \$4 00
inches. 1 doz. in package

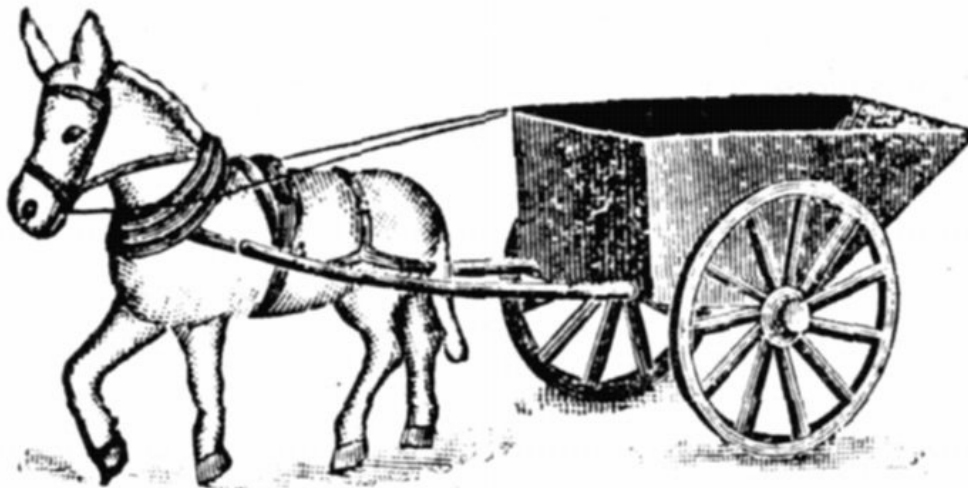

No. 570.

Dozen.

570. Mule Cart.

As cut. Painted. Length, 9 inches. ½ \$4 00

dozen in package



No. 15M.

Dozen.

15M. Mechanical Rowers,

a new attractive toy, the rowers go through the motion of rowing as the toy is drawn along. Length, 8 inches. Each in a box

\$5 50

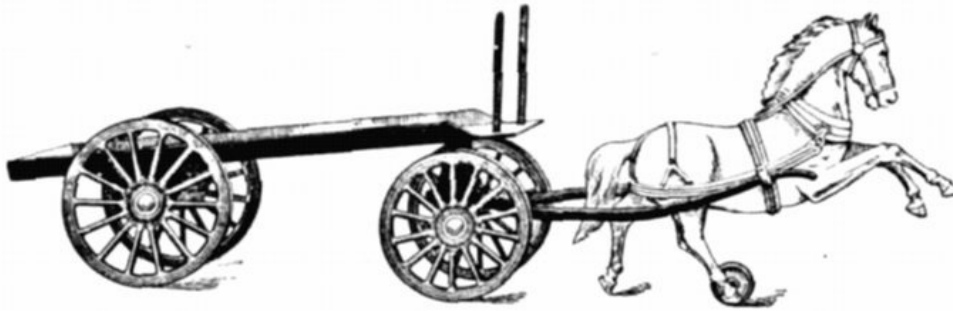

No. 236.

Dozen.

236. Truck,

with 1 horse; painted. Length, 14 inches, 1/4 dozen in package

\$6 00



No. 55 1/2.

Dozen.

55 1/2. Surrey,

1 horse, no driver. Length, 11 3/4 inches. Each in a box

\$6 00



No. 18.

18. Trap,

Dozen.

with horse and driver, painted. Length, 12 inches. Each in a box \$6 00

27. Dump Cart,

Dozen.

with horse and driver. Length, 10¾ inches. ½ dozen in package \$6 00

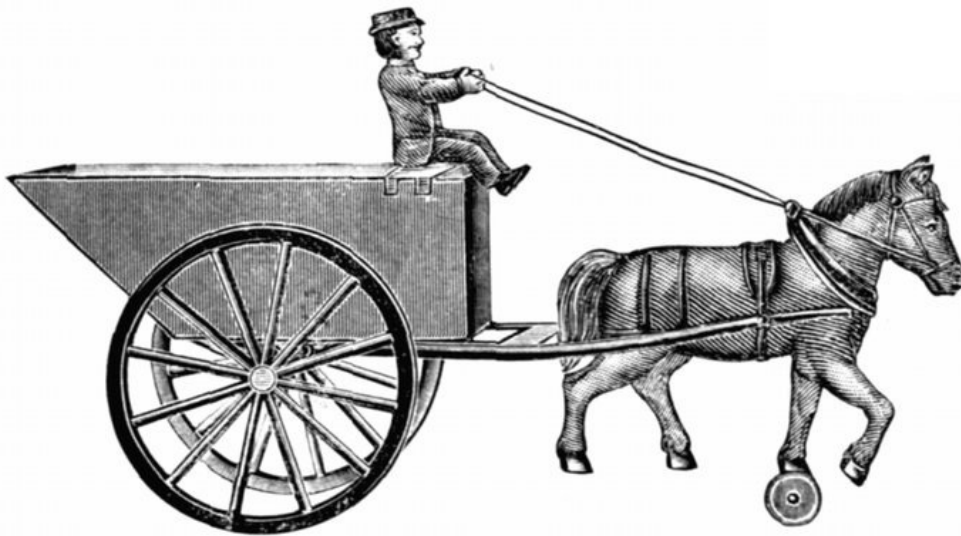

No. 27.

93. Mule Dump Cart,

Dozen.

similar to above, but with mule and driver; painted. Length, 10½ inches. Each in a box \$6 00



No. 28.

28. Pig Push Toy,

Dozen.

with stick handle; brightly painted. Size, 7½ × 6¼ inches. ½ dozen in package \$6 50

M96. Road Cart,

with 1 horse and driver. Length, 10 inches 7 20

237. Truck,

with 1 horse; driver and load. Similar to cut No. 226. Painted. Length, 17 inches. Each in a box \$13 00

239. Ox Cart,

a two-wheeled ox cart dray, with 1 ox and driver. Painted. Length, 16 inches. Each in a box 13 00

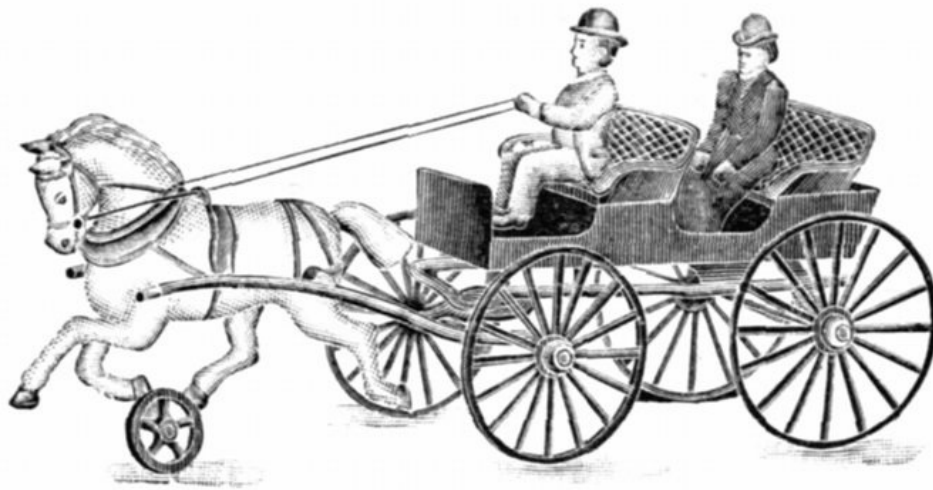

No 174.

174. Surrey,

177. Surrey,

Dozen.

two seats, 1 horse; painted. Length, 14 inches. Each in a box \$13 00
 two seats with occupants, 2 horses; painted. Length, 14 inches. Each in a box 13 00



No. 95.

95. Farm Waggon,

Dozen.

1 horse and driver; painted. Length, 15 inches. Each in a box \$13 00



No. M39.

M39. Ice Waggon,

M49. Trap,

M64. Phaeton,

Dozen.

1 horse and driver; painted. Length, 15 inches. Each in a box \$16 00
 in similar size to above. Each in a box 16 00
 in similar size to above. Each in a box 16 00

IRON FIRE DEPARTMENT.

Fire Engines.



No. 170.

M85. Fire Engine,

M87.

170.

Dozen.

with 1 horse and driver, painted, 7 inches long; ½ dozen in package \$ 3 00
 As M85, but 2 horses and is larger; ½ dozen in package 4 00
 As cut. Painted, with 3 horses and driver. Length 9½ inches; each in a box 6 50

Hook and Ladders.



No. 133.

M86. Hook and Ladder,

M88.

133.

Dozen.

with horse and driver, painted, 8 inches long; ½ dozen in package \$ 3 00
 As M86, but 2 horses and 2 men, 9½ inches long; ½ dozen in package 4 00
 As cut. Painted, 12 inches long; each in box. 6 50



No. 115.

Dozen.

115.

As cut. Painted, with 2 horses and driver. Length 13 inches; each \$13 00 in a box

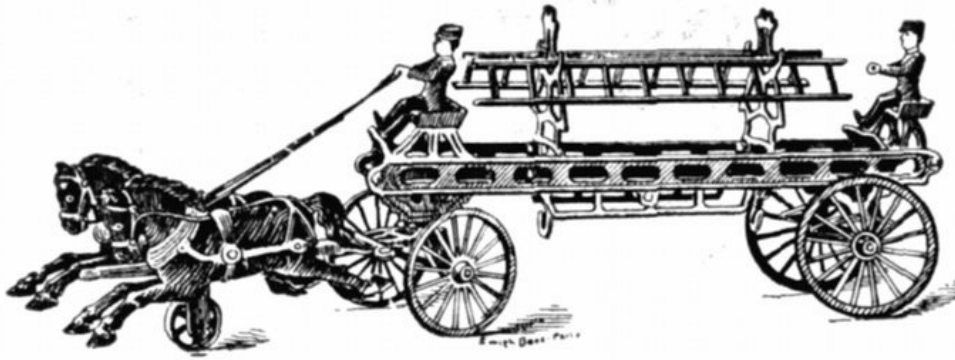

No. 117.

Dozen.

117.

As cut. Painted, 19 inches long; each in \$13 00 box



M72.

Dozen.

M72.

As cut. Painted, gilt trimmed; with three horses and driver. \$16 00 Length 16 inches; each in a box

M75.

Painted, similar to above, with 3 horses, 2 firemen, has gong. 32 00 Length 20 inches; each in a box

M81.

Painted. A very large and handsome 3 horse engine complete, with two firemen, hose connection, etc. Length 22 inches; each in a box 60 00

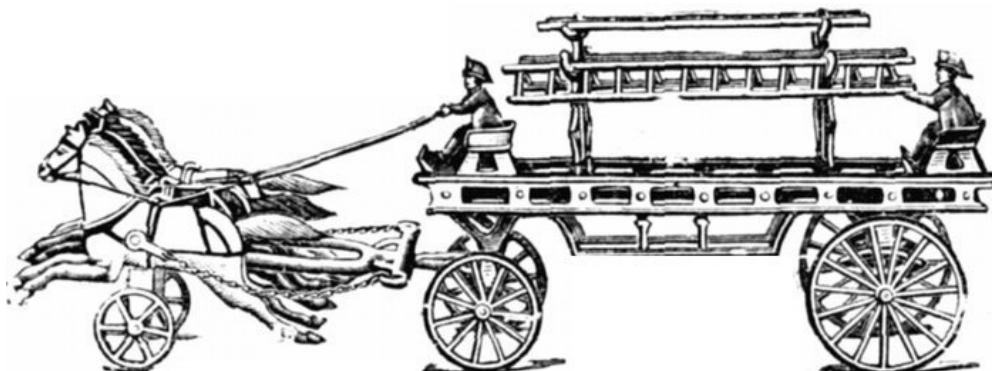

No. M72.

M73.

M76.

M82.

Dozen.

As cut. Painted, 3 horses, 2 firemen, 3 ladders. Length 19 inches; each in a box \$16 00
 Painted, similar to above, has 3 horses, 2 long ladders, 2 shorter ones, firemen, buckets, axe, etc. Length 28 inches; each in a box 32 00
 Painted and nickel finish, similar to above but larger and finer equipped. Length 31 inches; each in a box 60 00

Hose Reel.



No. 39.

39. Hose Reel,

Dozen.

with horse and driver, painted; each in a package \$ 6 50

NERLICH & CO.

REMOVAL NOTICE.
 About January 1st, 1901, we will remove to our new warehouse, directly opposite the Union Station, on Front Street.

IRON TRAINS.



120. Nickel.

121.

121¾.

Dozen.

Engine, tender and coach; 10½ inches long; ½ dozen in package \$2 50
 " " " " 2
 coaches; 16 " " ½ 4 00
 " "
 " " " " 3 " 21
 " " ¼ " " 6 00

150.

" " " " 4 " 26 8 00
 " " 1/4 " " "

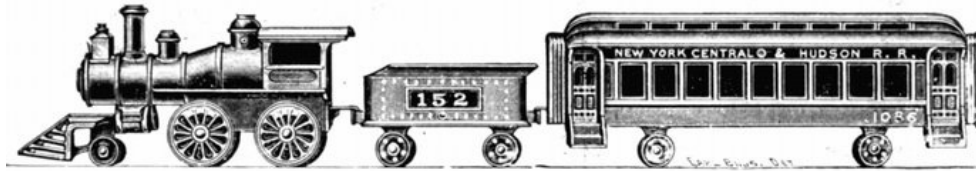

M91. Painted.

Engine, tender and coach, 17 inches long; each in box \$8 40

M93.

" " " 1 coach, flat car and caboose; 28 inches long; each in box 12 50

M12.

" " " and 3 coaches; 34 inches long; each in box 14 40

M18.

" " " " 4 " 41 16 80

M13.

" " " flat car and coach; 36 inches long; each in box 26 40

M16.

" " " coach, flat car and caboose; 42 inches long; each in a box 32 00

TOY SCALES.

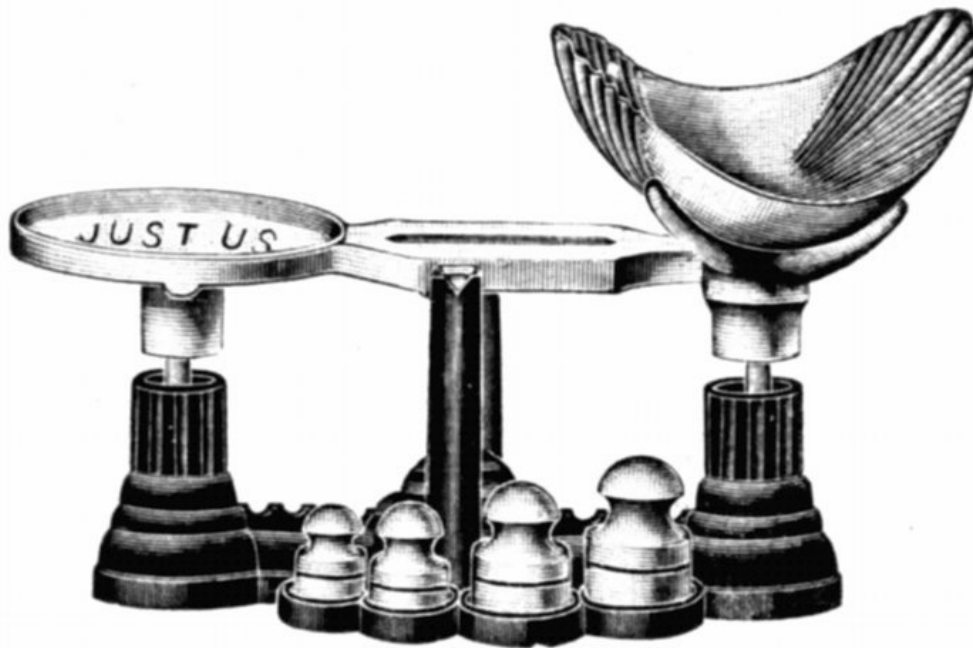

20.

Dozen.

Malleable iron stand, painted. Length, 4 1/2 inches; height, 2 1/2 inches, 4 inch scoop, 3 weights \$1 70

10.

As cut. Malleable iron, painted. Length, 4 3/4 inches; height, 3 1/2 inches, 4 3/4 inch scoop, 4 weights 4 00

HAMMERS.



246.

16.

Dozen.

Claw hammer, plain round wood handle, ½ dozen in package \$0 84
 Lady's hammer, 1 dozen in package 1 50

HATCHETS.



400.

450.

Dozen.

Red painted head, wood handle. Length, 9 inches, 1 dozen in package \$0 84
 Large size, red painted head, wood handle. Length, 12 inches, 1 dozen in package 1 60

IRON STOVES.



PET, Small.

Dozen.

White nickel finish, one swinging door. Length, 3 inches. 1 dozen in a package \$ 2 50

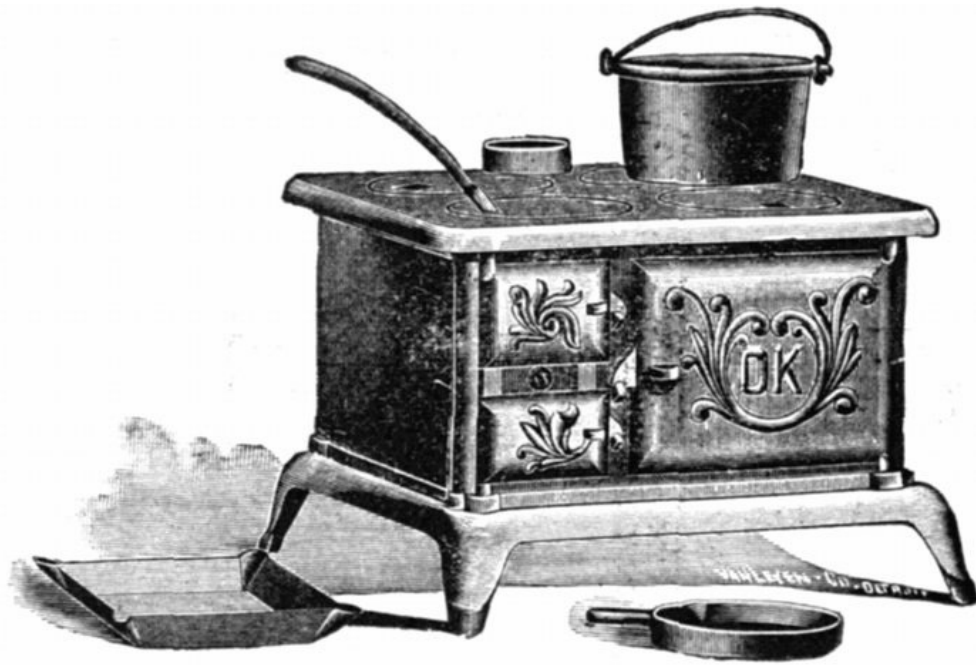

O.K., With Fittings.

Dozen.

White nickel finish, one swinging door and loose lids, fittings as shown in cut. Size, 5 x 5 x 3½ inches high \$ 7 50

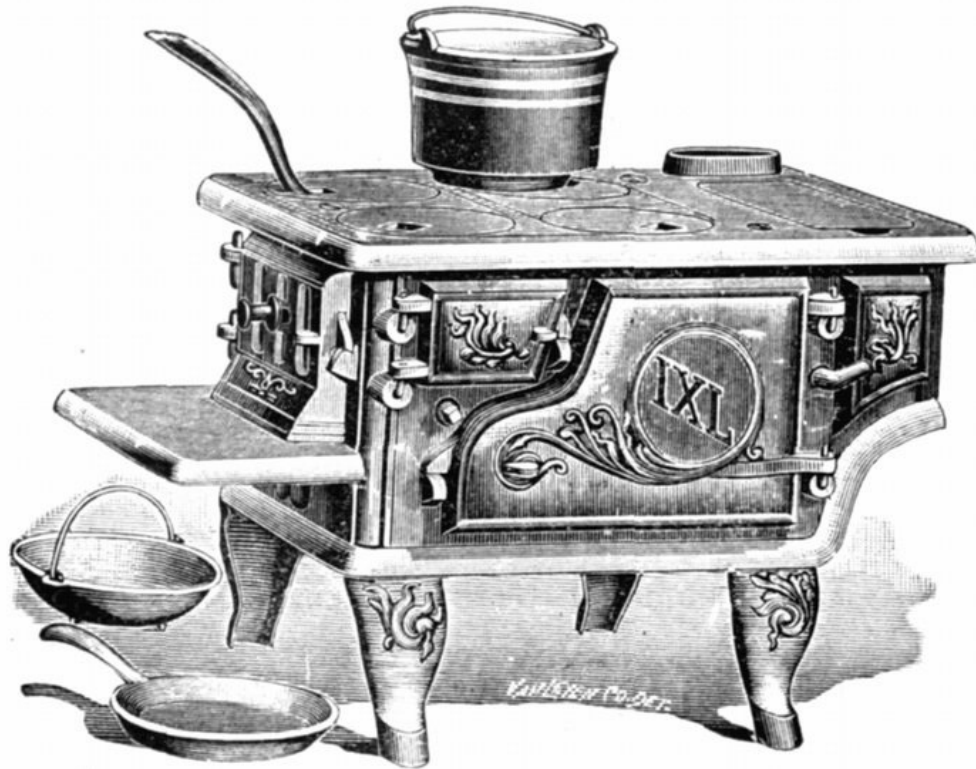

IXL. With Fittings.

Dozen.

White nickel finish, swinging doors, loose lids. Fittings as shown in cut. Size, 8¼ x 5½ x 5¼ inches high \$14 40

PET. With Fittings.

White nickel finish, swinging doors, loose lids and grate, detachable hearth, reservoir and fittings as shown in cut. Size, 11½ x 6 x 7 inches high \$32 00

TOY SAD IRONS.

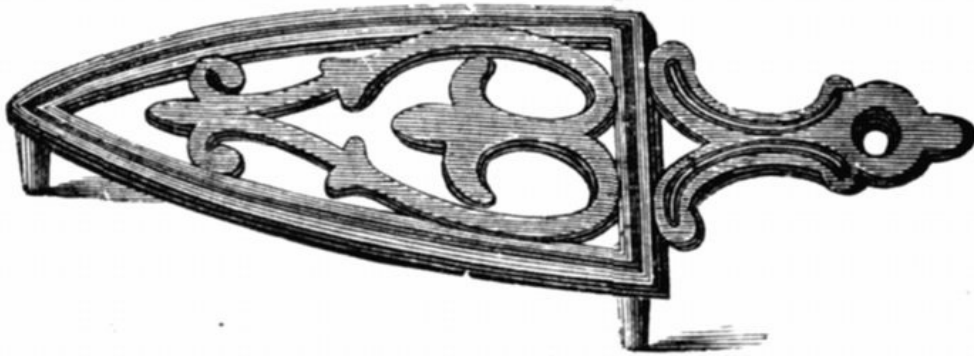
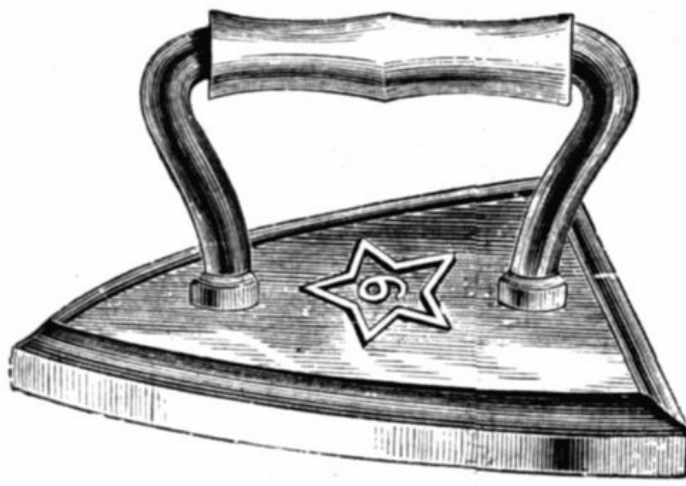

2.

5.

Dozen.

Flat shape, polished face, black enamelled top finish. Length, 3 inches; with 4½ inch coppered stand; 1 dozen in package

\$ 0 80

As above, but 3¾ inch iron, and 6 inch stand; ½ dozen in package

1 60



Artisan.

Artisan.

4 Toilet.

Dozen.

As cut. Finely finished
and with wood grip
patent detachable
handle. Length, 4
inches \$ 3 60
As above, but 5 inch
size 5 50

White Nickel Jackstones.



0.
1.
2.
4.

Gross.

2 gross in a box \$ 0 36
2 gross in a box 50
1 gross in a box 70
1 gross in a box 1 00

IRON BANKS.



No. 8.

Painted, with Lock and Key.

6.

8.

13.

Dozen.

Size, $2\frac{1}{2} \times 1\frac{3}{4} \times 2$ inches, $\frac{1}{2}$ dozen in package	\$ 1 60
Size, $3 \times 2\frac{1}{4} \times 2\frac{1}{2}$ inches, $\frac{1}{2}$ dozen in package	2 50
Size, $4 \times 2\frac{3}{4} \times 2\frac{3}{4}$ inches, $\frac{1}{3}$ dozen in package	3 50



No. 26.

Nickel, with Lock and Key.

26.

Dozen.

As cut. Imitation combination, key lock, nickel plated. An extra large and strong bank for the money. Size, $3\frac{1}{2} \times 2\frac{1}{2} \times 2\frac{1}{2}$ inches

\$ 3 00



No. 243½ Combination.

Combination Lock.

As cut 243½, all are finely nickered and are fitted with a new and perfect working combination lock.

242½.

243½.

244½.

Dozen.

Size 4¼ × 3⅓ inches,	
½ doz. in box	\$ 6 00
" 5½ × 4¼ "	12 00
each in box	
" 6½ × 5 " " "	24 00

House Shape.

Lacquered and Bronzed.

250.

265.

Dozen.

Double house style.	
Size, 5 × 4 × 3 inches,	\$ 4 00
½ dozen in package	
Same as 250, but size	
5½ × 4¾ × 3½ inches,	5 50
and has lock and key	
door	

TIN BANKS.



No. 355/19.

355/19.

356/26.

Gothic.

356/4AB. Assorted with Lock and Key.

Dozen.

As cut. Handsomely lithographed. Size, 3 × 2¼ inches. 1 dozen in package \$ 60

As above, but size 3 × 3 inches. 1 dozen in package 80

Gothic shape, painted and bronzed. Size, 4 × 2¼ inches. 1 dozen in package 80

Includes house, trunk shape, and barrel shape. Sizes, 2½ × 2¼ inches. 1 dozen of each in package 80

STEAM ENGINES.

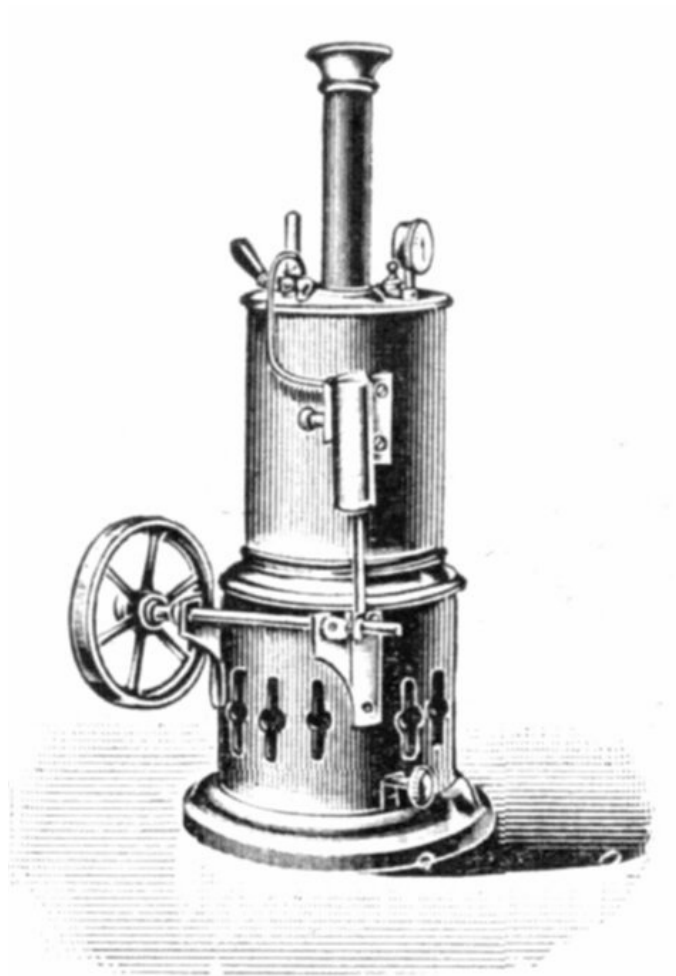

Nos. 14/717 & 14/718.

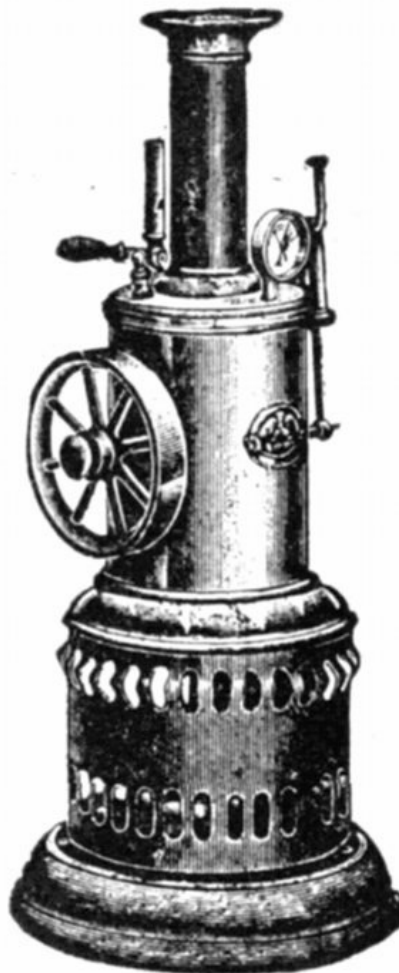

No. 14/684.

Made of sheet steel, lacquered in imitation brass, nickel trimmed, perfectly modelled and complete in all details, every one guaranteed to work perfectly if properly handled.

19/53.

14/716.

14/685.

14/717.

14/718.

14/684.

Fine quality engines, finely finished and extra powerful.

Dozen.

Height 7 inches	\$4 50
" 8 "	7 50
" 8½ " solid	12 00
brass boiler	
" 10 " as cut	18 00
" 11½ " solid	24 00
brass boiler	
" 12½ " " " "	42 00

14/111.

14/112.

Each.

Height 9 inches	\$ 2 50
" 10½ inches	4 00

Steam Boats.

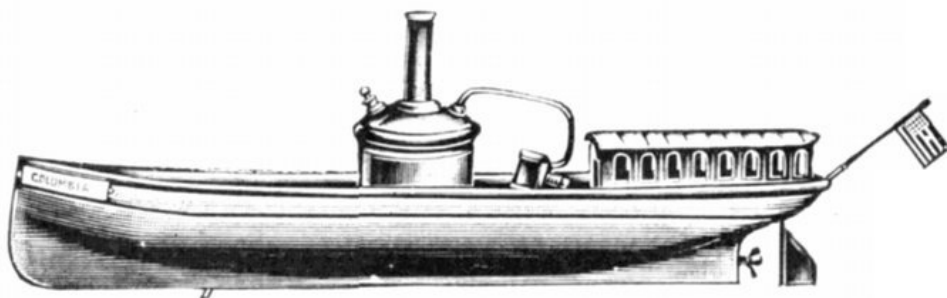

No. 14/434.

Dozen.

14/756.

Made of good quality sheet metal; painted and decorated in bright colors, has engine with spirit burner complete. \$7 20

14/434.

14/757.

Length, 10 inches	
As above. Length, 14 inches	14 40
" " " 19 "	20 40

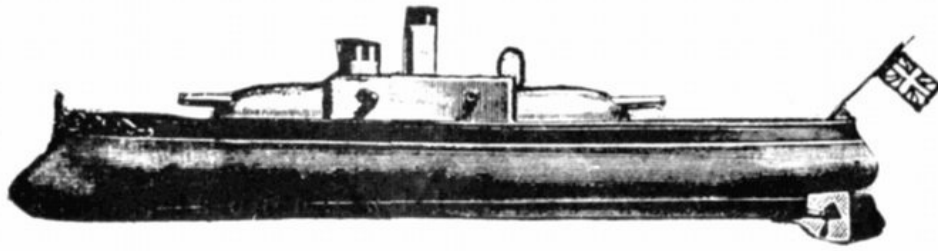

No. 14/720.

14/720. Torpedo

14/721. Trader.

14/722. Cruiser.

Dozen.

boat. As cut. Length, 18 inches	\$24 00
---------------------------------	---------

Each.

Has raised deck and extra powerful engine. Length, 18 inches	\$4 00
Very complete in details and handsomely decorated in white enamel, red and gilt. Length, 19 inches	7 50

HOT AIR MOTORS.

IMPROVED MODEL.

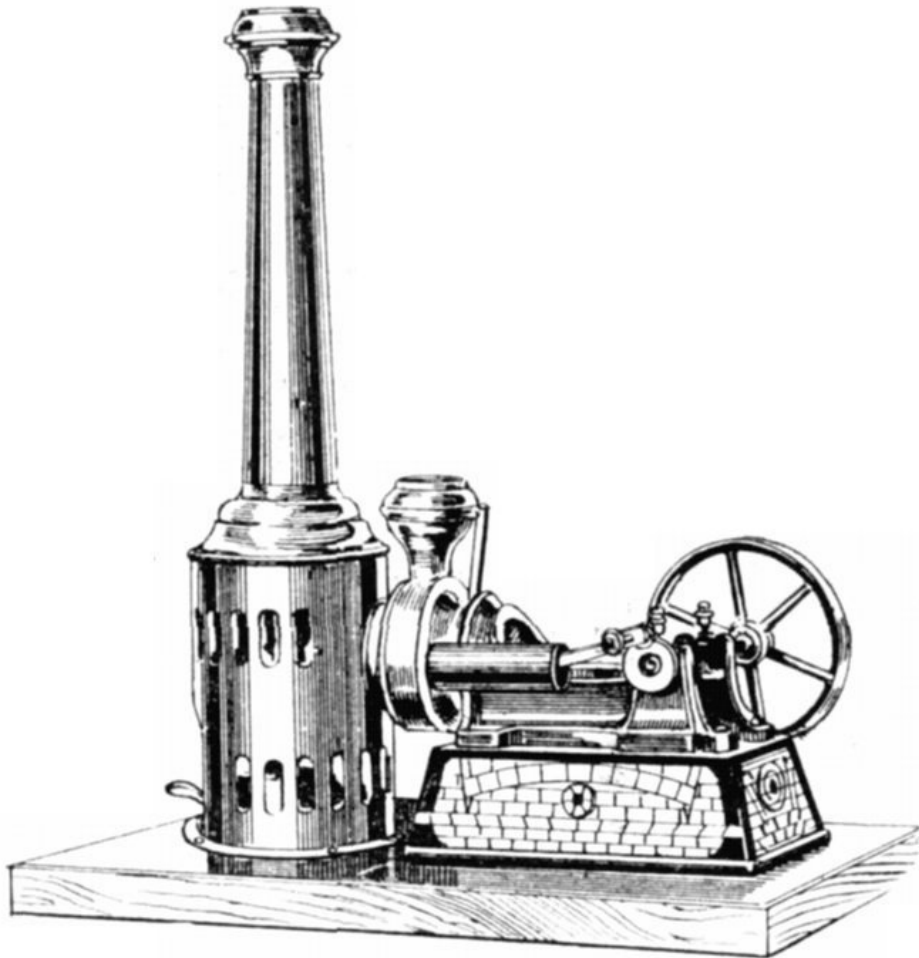

No. 14/679.

14/679.

Dozen.

As cut. Iron frame. Russian iron and nickelled body; mounted on polished wood base, size 9¾ × 6 inches. Height, 10½	\$24 00
---	---------

14/680.

inches. Extra good value
Same style as above but is more powerful and has two water tanks on platform elevated above motor on bridgework, with steps leading up. Size of base, $12\frac{1}{2} \times 6\frac{1}{2}$ inches. Height, $11\frac{1}{2}$ inches 54 00

Upright Shape.

14/379.

Dozen.

Good quality Russian iron and brass lacquer finish; body mounted on wood base. Height, $8\frac{1}{2}$ inches \$5 50

14/380.

As cut. Russian iron burner compartment, nickel and fine brass trimmed working parts; wood base. Height, 13 inches. Very attractive, and is a perfect working motor \$21 60



No. 14/380.

ATTACHMENTS.

For Steam Engines, Hot Air Motors and Electric Motors.

14/739.

Dozen.

Assorted. Plastic tin figures, painted in bright colors. Three kinds, "Dog Ringing Bell," "Working Blacksmiths" and "Girl Skipping." 1 of each in box

\$4 00



No. 14/749.

14/749.

Windmill on tower similar to cut. Painted in bright colors. Height, 8 inches

5 50



No. 14/383.

14/383.

14/742.

14/682.

Dozen.

Working Fountain. As cut. Is made of heavy tin finished in bronze, and provided with pump so that when top basin is filled with water and power attached the nozzle throws up the water to be caught again in the basin. Height of fountain, 7 in.

\$7 50

Dozen.

Balloon Boat Wheel. Similar to Ferris Wheel, but has in place of cars, boats with occupant and floating balloon above each; brightly painted. Height, 9½ inches
Windmill, on metal bridgework tower; painted. Height, 12 inches

\$8 00

\$14 40



No. 14/707, see description next column.

14/707.

14/683.

Dozen.

Ferris Wheel. As cut.
 Brightly painted
 framework and cars. \$42 00
 Height, 12½ inches
 Incline Railway. Has
 station top and bottom.
 When power is
 attached the car keeps
 ascending and
 descending the incline 72 00
 track, reversing each
 time it reaches a
 station. Length of
 structure, 19 in.;
 height, 15 in.

ELECTRICAL TOYS.

Every machine is accurately constructed and guaranteed to work perfectly if properly used, every one being tested and found in good working order before leaving the factory.

They are not only toys, amusing to both children and adults, but practical machines for studying magnetism and electricity.

INDUCTION COIL.

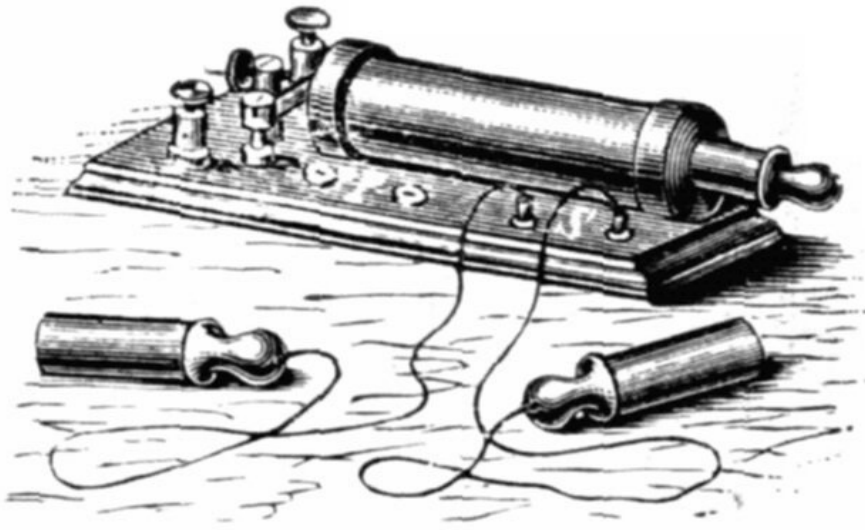

387/1.

Each.

Mounted on mahogany polished base, $4\frac{3}{4} \times 3$ inches; has brass vibrator posts, set screw and binding posts, nickel magnet tube for regulating strength of current, three handle pin sockets.

\$ 3 50

While this article is cheap enough for a toy, it is still good enough for medical purposes

MOTOR.

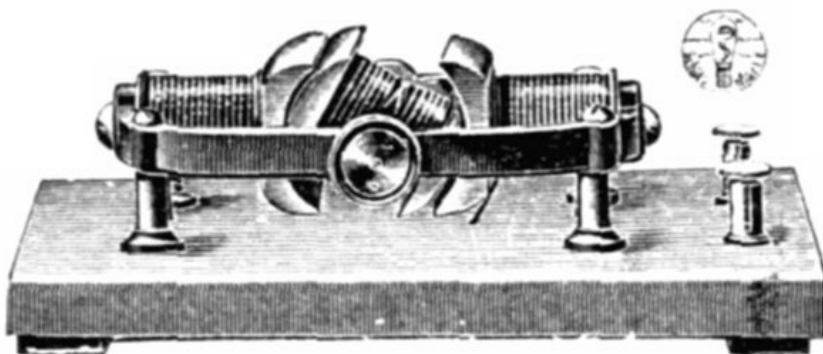

387/3.

Each.

Mounted on mahogany polished base, $6 \times 3\frac{1}{2}$ inches, solid iron frame, supported on brass posts, brass binding posts. Can be used to run small attachments or window pieces

\$4 50

"ANCHOR" MOTOR.

387/4.

Each.

Mounted on polished mahogany base, $6\frac{1}{2} \times 4\frac{1}{2}$ inches. Same style as cut, but has *three* double upright magnets, nicely painted and decorated; brass posts.

\$9 00

This machine is extra strong and powerful, and will run any small

BATTERY CELLS.

Dry Storage Cells for above

Each.

\$1 00

MAGIC LANTERNS.

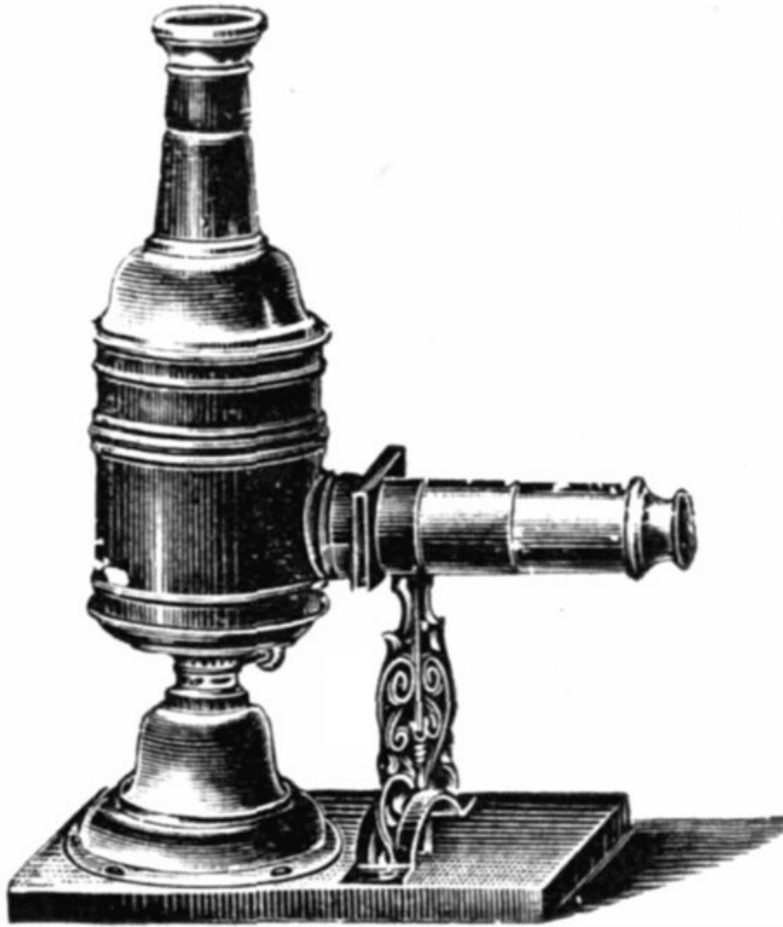

No. 19/36.

19/36.

Upright shape, as cut, made of good quality tin and japanned fancy colors pattern, assorted colors, brass and nickel trimmed Each in a box complete with 12 slides, in the following sizes:—

- 14/586.**
- 14/587.**
- 14/588.**
- 14/589.**
- 14/590.**

Dozen.

Upright shape, as cut. Made of good quality tin, painted in bright red; brass and nickel trimmed. Height, 9½ inches; each, complete with 12 slides.

\$ 6 50

Dozen.

Height 10¾ in., takes 1⅞ in. slide
 " 11½ " 1⅞ " " 12 00
 " 13 " 1¾ " " 16 80
 " 14 " 1½ " " 21 60
 " 15 " 1¾ " " 30 00

\$ 8 40

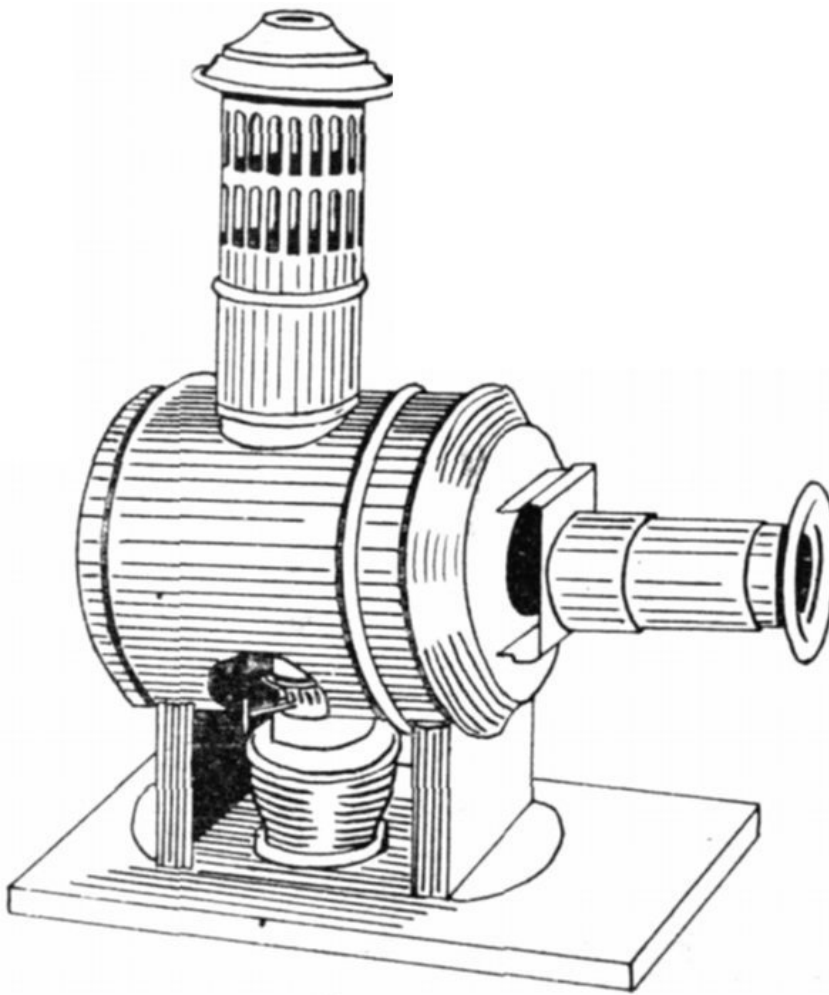

No. 14/681.

14/681.

An extra large lantern for the price.
 Horizontal body, made of good quality tin, red painted, nickel trimmed. Each in **double opening wood box** with 6 long slides and 3 circular slides, as in cut 14/577 below.

Dozen.

Horizontal shape, as cut. Made of good quality tin, black japanned, nickel and brass trimmed. Height \$26 40
 12½ in. Each in box complete with 12 slides.

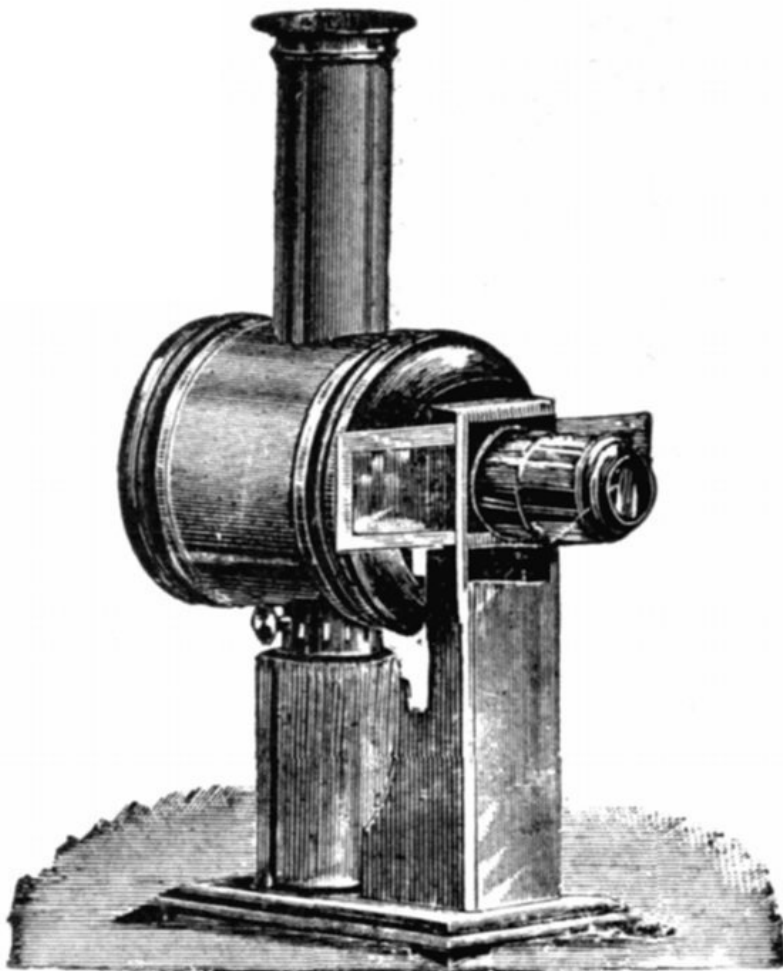

No. 14/575.

14/574.

14/575.

Dozen.

Height 10½ in., takes	\$19 20
1¾ in. slide.	
" 12½ " 1½ "	27 00

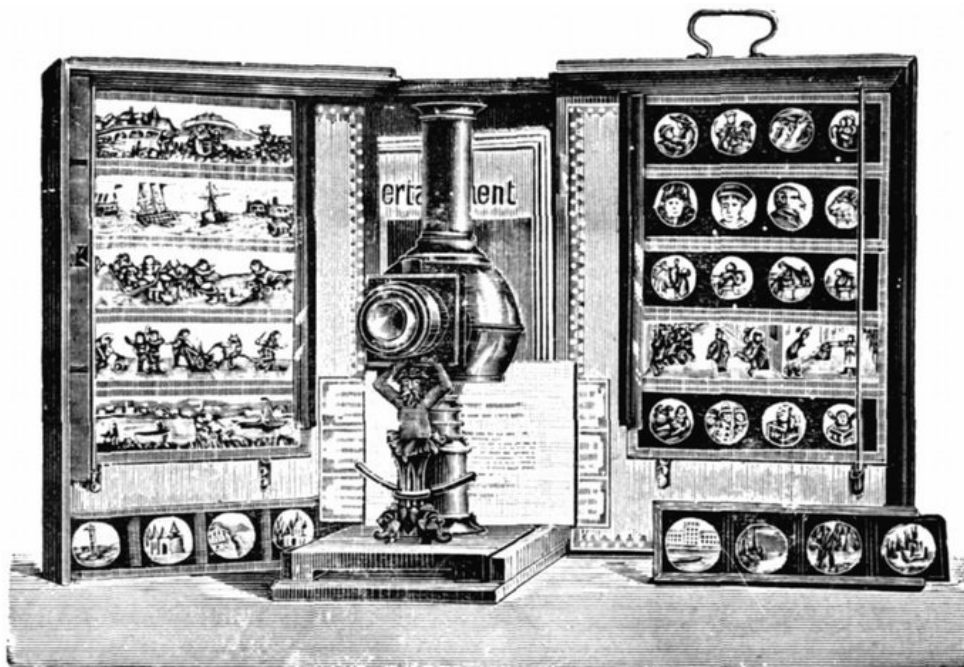

No. 14/577.

Globe shape body, finished in brass all through. Each Lantern put up in leatherette covered wood box, double opening as shown in cut. Has 10 long sides, 1 comic changing scene slide and 1 mechanical kaleidoscopic view.

14/576.

14/577.

14/578.

Dozen.

Height 10½ inches,	\$38 40
takes 1¾ inch slide	
" 11½ " " 2 "	60 00
" 13½ " " 2¼ "	78 00

**MAGIC LANTERNS.
Nerlich & Co's. Specialty.**

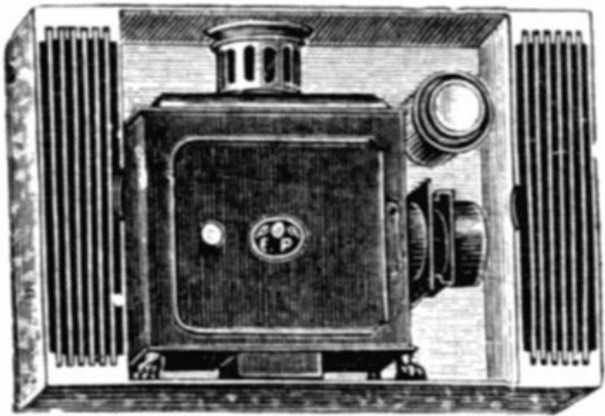

Russian tin iron, square shape, in wood box with hinge cover. Each with 1 dozen long slides.

- 14/700.**
- 14/546.**
- 14/547.**
- 14/548.**

Dozen.

Height 9 in., takes 1¼ in. slide.	\$20 40
" 9½ " " 1½ "	30 00
" 10¾ " " 2 "	38 40
" 10¾ " " 2¼ "	48 00

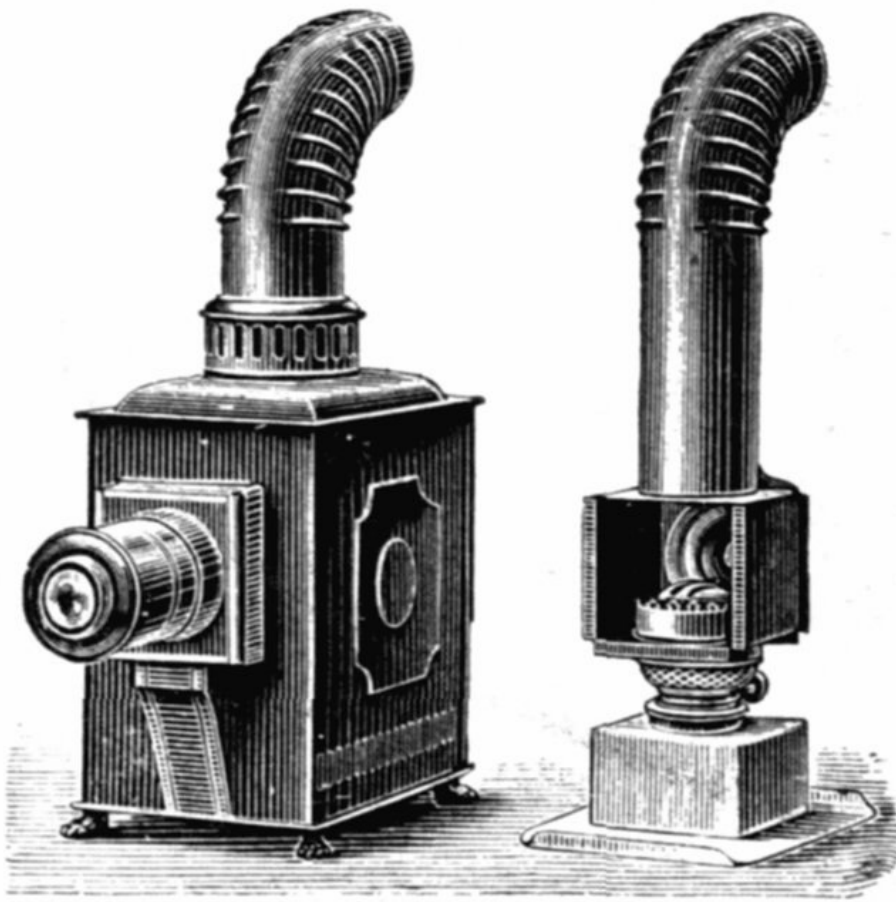

Russian tin iron, square shape with "Duplex" lamp; brass trimmed. First class Lanterns, and suitable for either home or school entertainment. Each complete in box with 12 slides.

- 14/549.
- 14/550.
- 14/551.

Each.

Height 18½ in., takes 2 in. slide	\$ 8 00
" " 14½ " " 2¼	10 00
" " 15½ " " 2¾	13 00

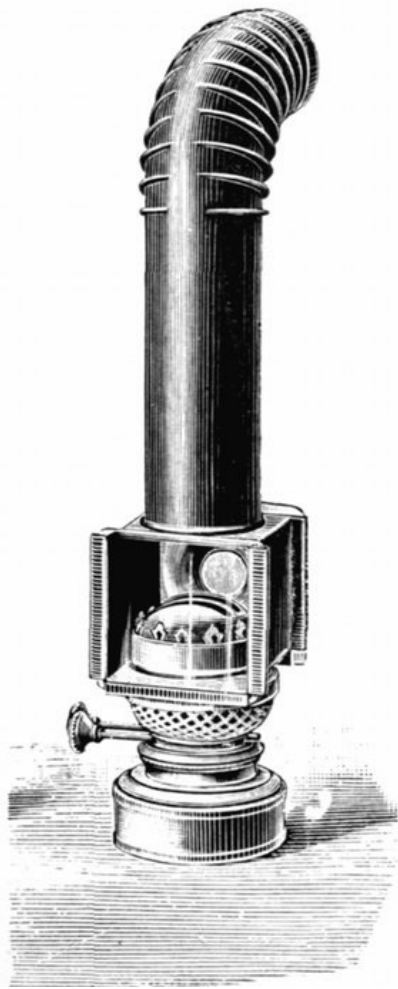

"Duplex" Lamp.

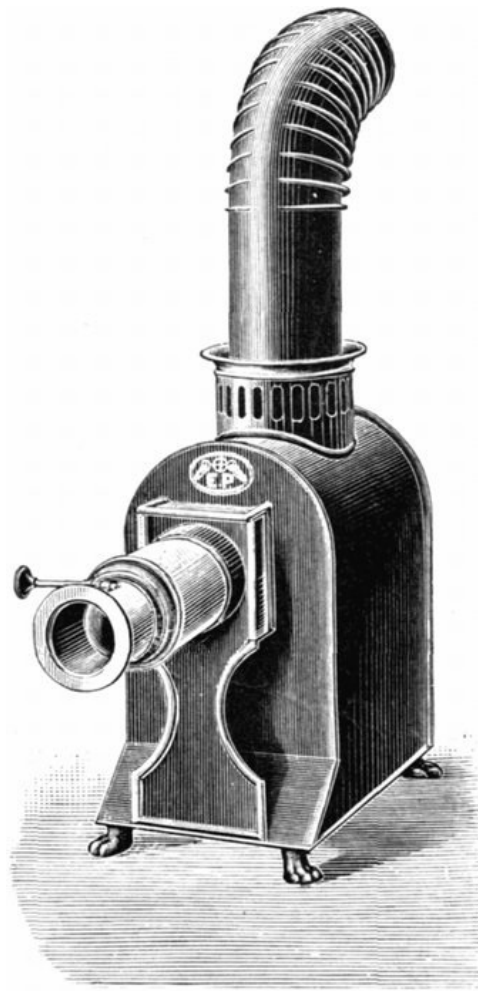

No. 14/552.

An extra superior line of Russian tin iron lanterns in new shape. Have extra strong "Duplex" lamps, and are first class throughout. Brass trimmed and brass lens adjusting screw. Each in box with 12 slides.

14/552.

14/553.

4238.

Each.

Height 19 inches, takes 2¾ inch slides \$18 00

Height 19 inches, takes 3 inch slides 22 00

Height 17 inches, takes 3¼ inch slides, and has with it in addition to the 1 dozen long slides, 3 moving slides 24 00

**MAGIC LANTERNS.
FOR CONCERT USE.**

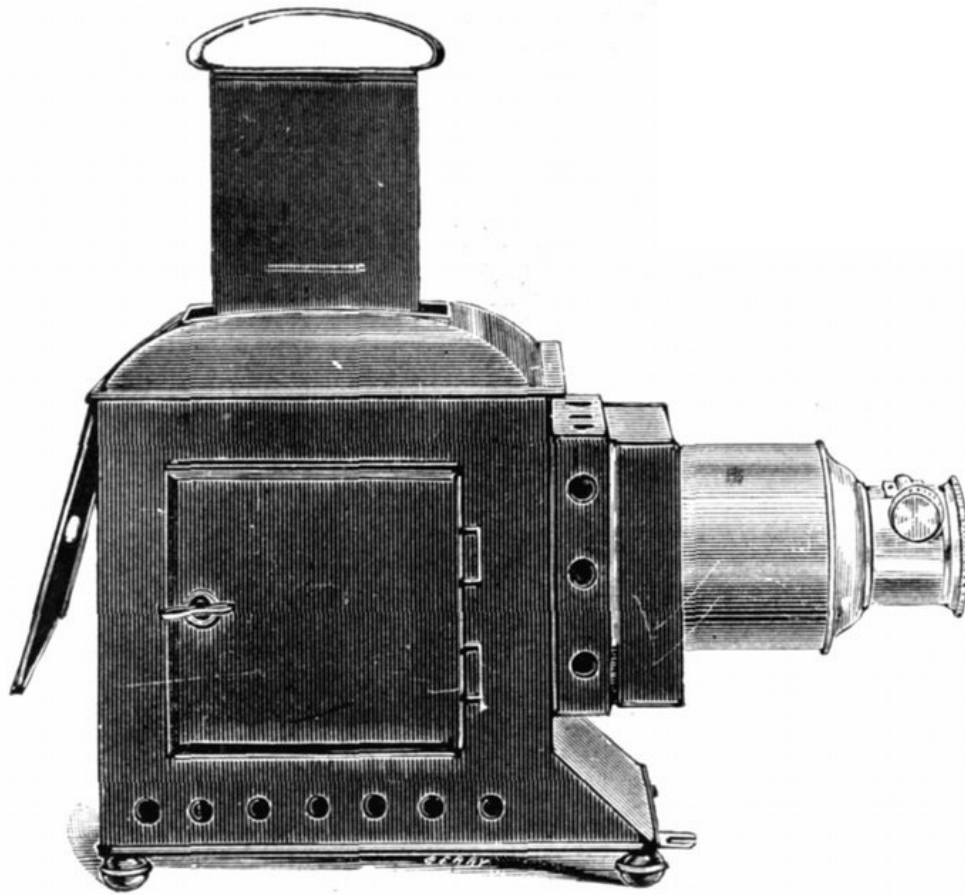

7A.

Three-wick Lamp

Each.

Russian tin iron, brass lens tubes and adjusting screws. Extra powerful lenses.

with patent extension chimney. This is a strictly first class lantern and adapted for use in quite large halls or lecture rooms.

\$18 00

No slides go with this lantern but with a slide holder $3\frac{1}{4}$ inch square slides can be used



Extension Chimney.

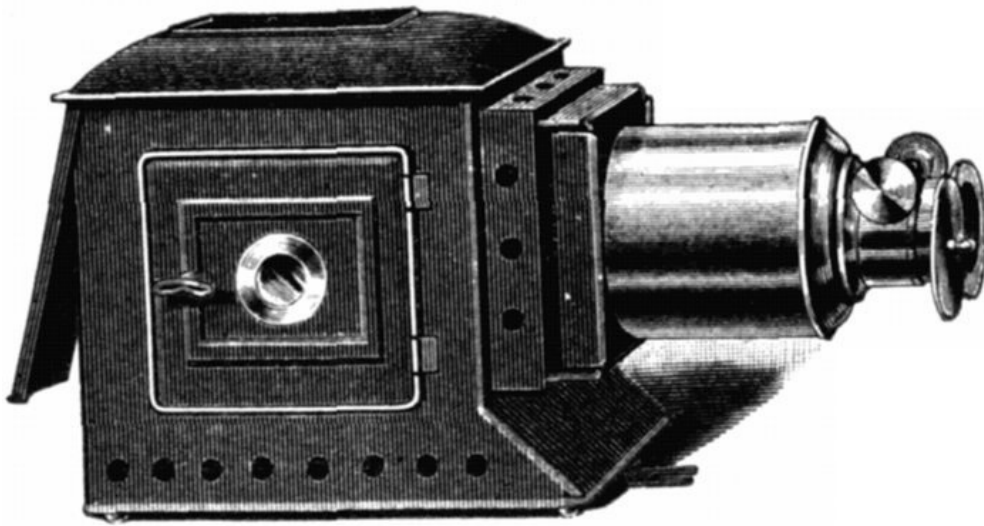

No. 8 1/4.

8 1/4.

Each.

Is a very superior Russian tin iron lantern somewhat similar in appearance to 7A, but is larger and finer quality throughout, and in addition is fitted with **Four-wick Lamp** with extension chimney as shown in cut. Without slides, but with a slide holder 3 1/4 inch square slides can be used

\$24 00



Slide Holder.

Slide Holder.

Wood slide holder and shifter for use with large Lantern

Each.

\$0 80

Magic Lantern Slides.

1 1/8
1 1/4
1 1/2
1 3/4
2
2 1/4
2 1/2
2 3/4
3
3 1/4
3 1/2
2 1/8
2

Dozen.

inches wide; 1 dozen in package	\$0 30
" " 1 " "	40
" " 1 " "	50
" " 1 " "	70
" " 1 " "	80
" " 1 " "	1 30
" " 1 " "	1 60
" " 1 " "	1 80
" " 1 " "	2 40
" Square Lithographic	2 50
" " Photographic	8 00
" " Panorama	1 60
wood frame slides	1 60
" " Lever comic	1 60
" " "	1 60

KINEMATOGRAPHS.

The Simplest and Most Satisfactory Moving Picture Machines.

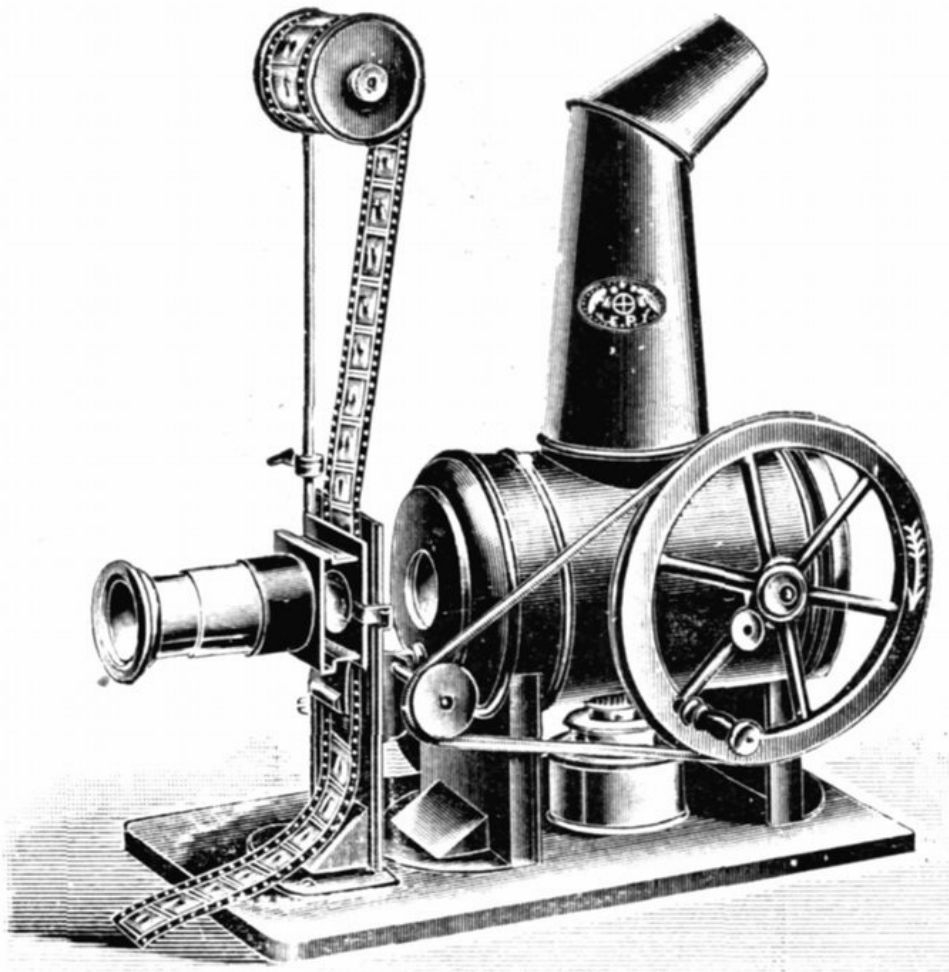

No. 14/701.

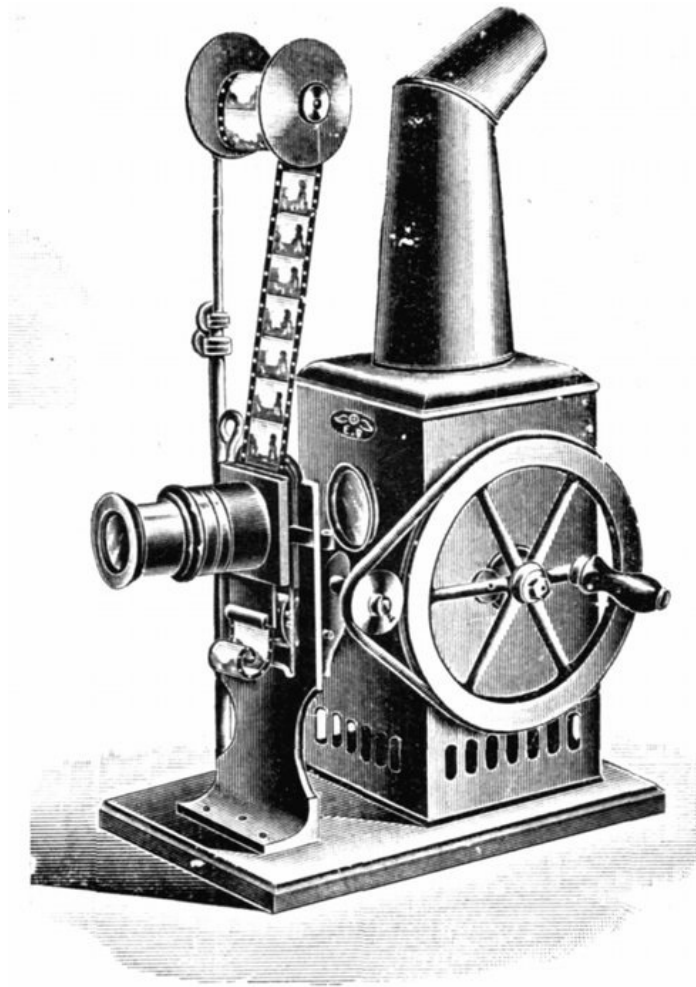

No. 14/702.

14/701.

14/702.

Each.

As cut. Red painted body, Russian iron chimney, set on polished wood. Has attachment to use as ordinary Magic Lantern (1¾ inch slides). Height of instrument, 13 inches. Complete with 3 lithographic films

\$ 8 50

As cut. Red painted body, Russian iron chimney, set on wood base. Brass lens tubes. Has attachment to use as ordinary Magic Lantern (2 in. slides). Height of instrument, 15 in. Complete with 6 lithographic films

15 00

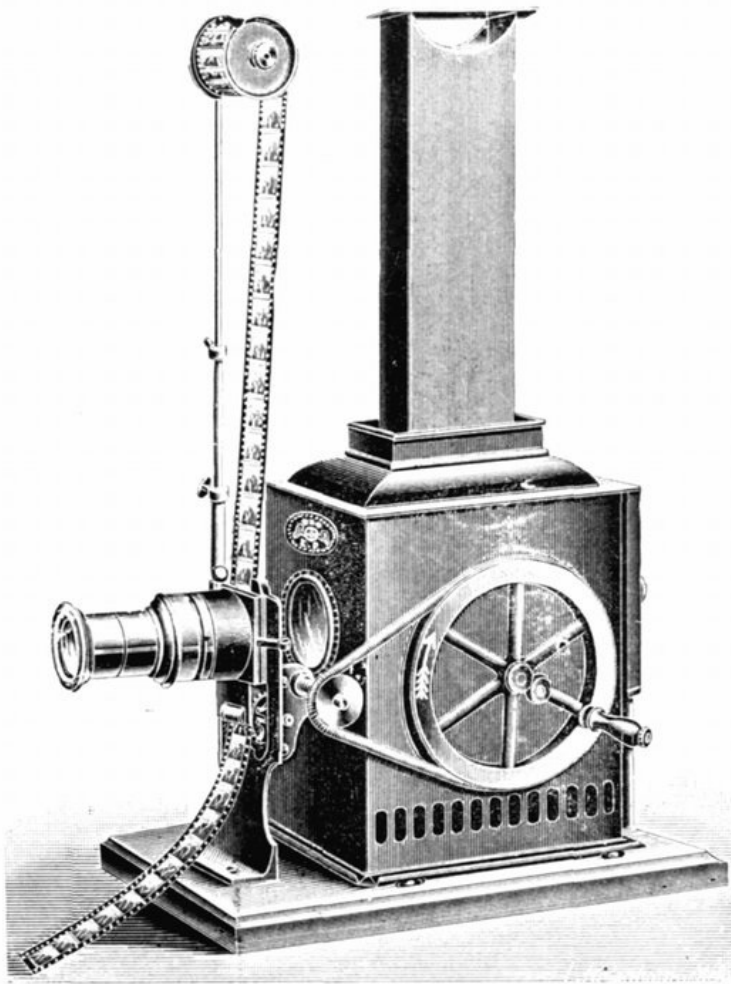

No. 14/704.

14/703. Extra Films

14/704.

14/706.

14/705. Extra Films

Each.

(lithographic), for Nos. 14/701 and 14/702 Kinematographs	\$ 0 46
As cut. Russian iron body. Extra strong lenses; three-wick lamp. Brass lens tubes. Has attachment to use as Magic Lantern (2¼ inch slides). Height of instrument, 20 inches. Complete with 6 lithographic films, and 1 photographic film	30 00
Similar to 14/704, but larger and much stronger lens, making this instrument very desirable for Exhibition purposes. Complete with 6 lithographic films and 1 photographic film (photographic) for Nos. 14/704 and 14/706 Kinematographs	40 00 2 50

A B C BLOCKS.

Embossed.



No. 46.



No. 12.

000.

46.

12.

Dozen.

Twelve pieces, flat shaped, embossed two sides, complete alphabet. Size of box 6½ × 5 inches

\$ 1 70

Sixteen pieces, natural wood, embossed ends, complete alphabet. Size of box 4¾ × 4¾ inches

2 40

Sixteen pieces, embossed ends, 32 illustrations of animals, with their names underneath. Several impressions of each letter and the numerals. Size of box 5½ × 5½ inches

4 00



No. 6.



No. 888.

6.

888.

92.

Dozen.

Twelve pieces, natural wood, printed in colors. Packed in paper boxes with fine label. Size of box 7¼ × 5½ inches \$ 4 50

Thirty pieces, natural wood, embossed and printed in colors, one hundred and eighty letters, figures and illustrations. Size of box 10¾ × 9 inches 12 00

Twenty pieces, with Mother Goose illustrations and rhymes; with alphabet complete. Painted and varnished, and water proof. Wood frame box. Size 11½ × 9 inches 20 50

Chautauqua Blocks,

Extra Good Value.

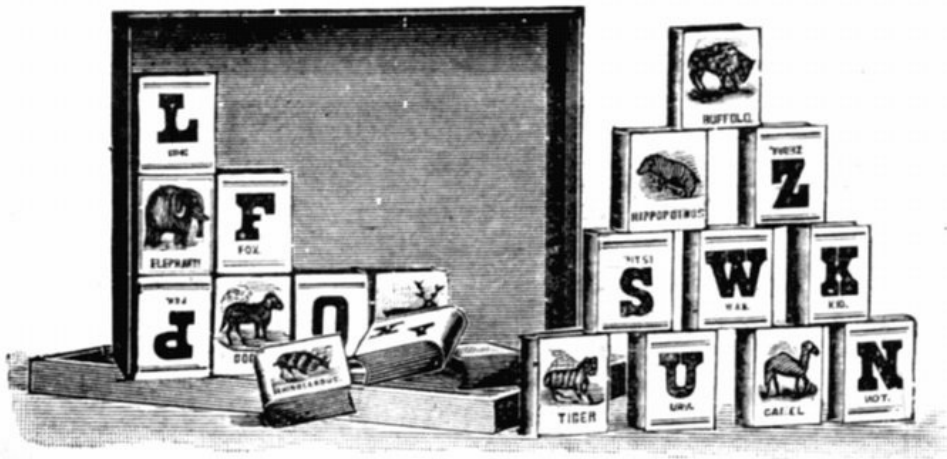

No 10X.

5.

10X.

15X.

Dozen.

Nine pieces, ¾ inch thick, natural wood, printed letters. Size of box 5½ × 5½ inches \$ 1 60

As cut. Twenty pieces, ¾ inch thick, printed with complete alphabet and numerous animals, etc. Size of box 10¾ × 7¾ inches 3 00

Twelve cubes, complete alphabet and numerous animals, etc. Size of box 7¼ × 5¾ inches 4 00

Paper Covered Blocks.



No. 481.

481.

12/101.

12/26.

486.

Dozen.

Kriss Kringle A B C, contains 16 pieces papered on two sides with alphabet in blue, gold and black; top cover in full colors and gold. Size of box 5 x 5 inches. 1 dozen in package \$ 1 20

Twenty-four pieces, objects in lithograph with names on one side and alphabet on reverse; plain edges. Size of box 10 x 4³/₄ inches. 1 dozen in package 1 60

Cubes, four sides covered, alphabet and pictures in two colors, twelve pieces. Size of box 6 x 4³/₄ inches 2 50

"Gem" picture A B C, eight pieces, chromo on both sides and alphabet on edges, size 7¹/₂ x 6¹/₂ inches 2 50



No. 502.

502.

510.

12/96.

Dozen.

Pussy cat picture A B C blocks, handsomely lithographed on two sides, 16 pieces. Size of box 8¼ × 8¼ inches \$3 60
 Assorted picture blocks, "Cock Robin," "House that Jack Built" and "Mother Goose," all have printed text for subject, nursery rhymes, alphabet and animal pictures, an extra good line. Size of box 14½ × 8 inches 5 50
 Handsomely lithographed blocks. Have both individual pictures and puzzle pictures, letters and small chromos on edges (24 pieces). Size of box 12 × 10½ inches 12 00

BUILDING BLOCKS.

In Wood Boxes with Sliding Covers.

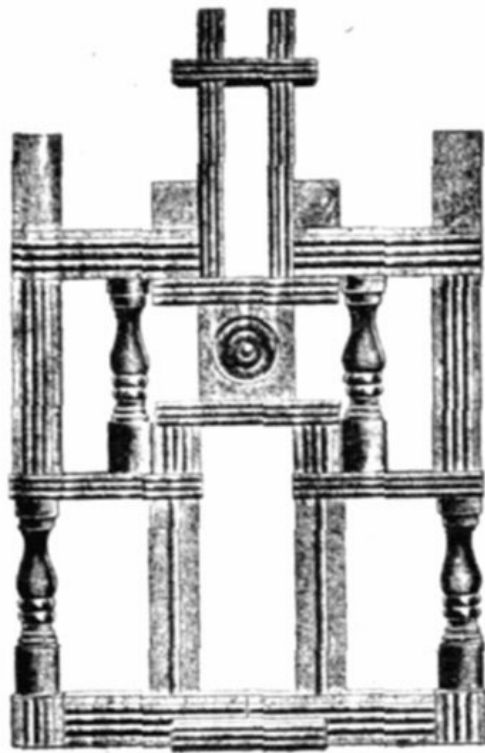

5A.

10A.

Dozen.

Size, 9 × 6 inches; 1 tier, 25 pieces, white and colored \$1 30

Size, 12 × 7½ inches: 1 tier, 40 pieces, white and colored 2 40

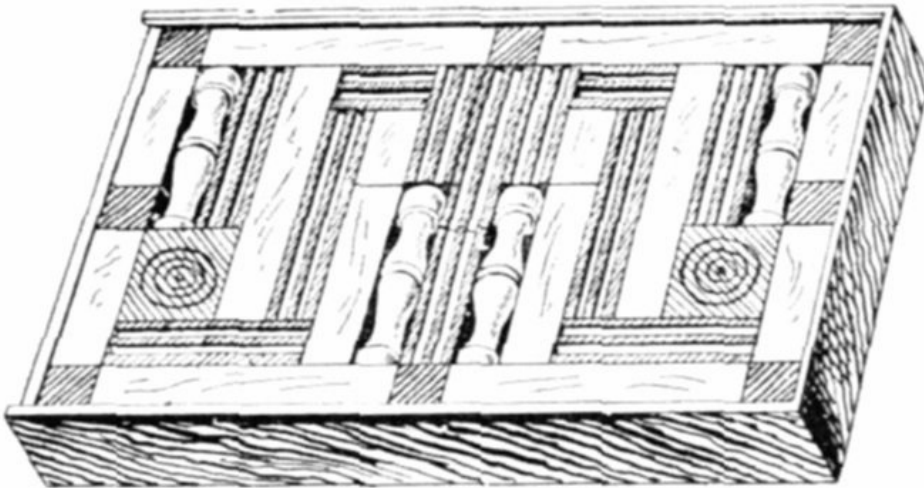

No. 15A.

15A.

Size, 12½ × 7½ inches; 2 tiers, 60 pieces, white and colored 4 00

Waggon Blocks.



No. 383.

An entirely new line, in different sizes, of waggons containing hardwood architectural building blocks. The waggons are nicely finished with lithographed sides.

382.

383.

Dozen.

Size, 10 × 4¾ × 2½ inches \$2 40

Size, 10¼ × 6¾ × 3¾ inches 6 00

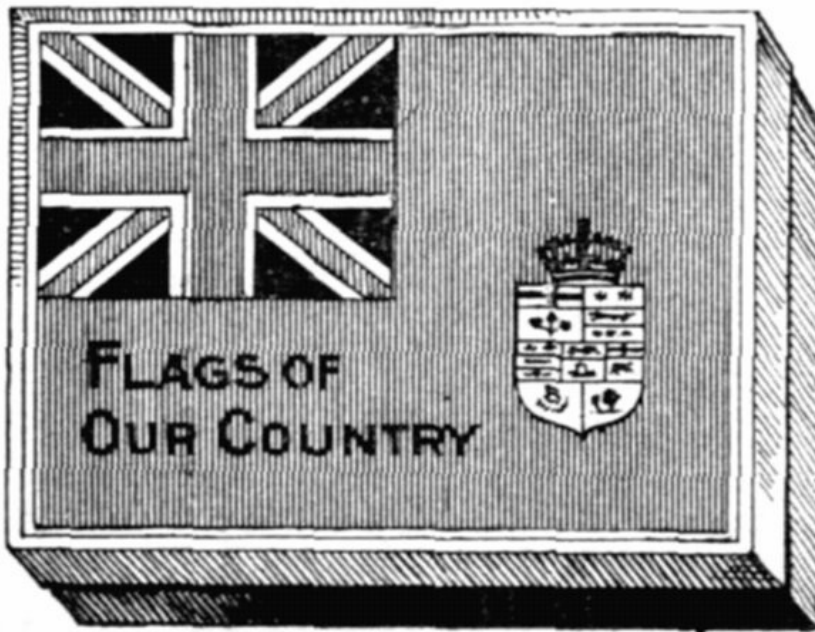

FLAG PUZZLE PICTURE BLOCK. See description on next column.

Picture Puzzle Blocks.

In Handsome Lithograph.

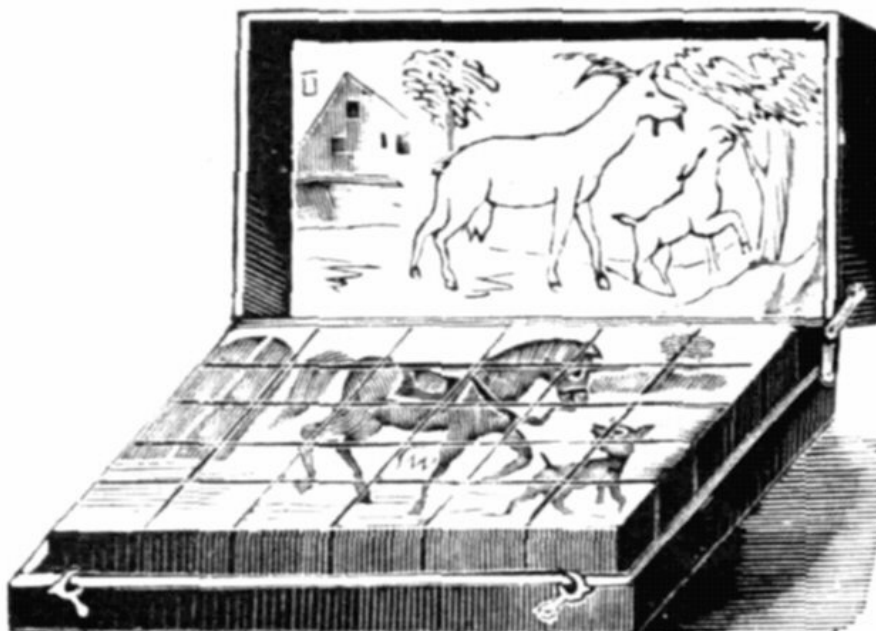

In paper-covered wood boxes with hinge cover and hook fastening. The blocks in each form six pictures, one of the copy subjects being found on the top of the lid and the

other five are inside the box.

14/84.

14/85.

12/86.

12/87.

12/88.

Dozen.

Size, 6½ × 5 inches. 12 blocks	\$3 00
Size, 7¾ × 6 inches. 12 blocks	4 00
Size, 8 × 6¼ inches. 12 blocks	5 50
Size, 9¾ × 8 inches. 20 blocks	8 00
Size, 12 × 10 inches. 20 blocks	16 00

Flag Puzzle.

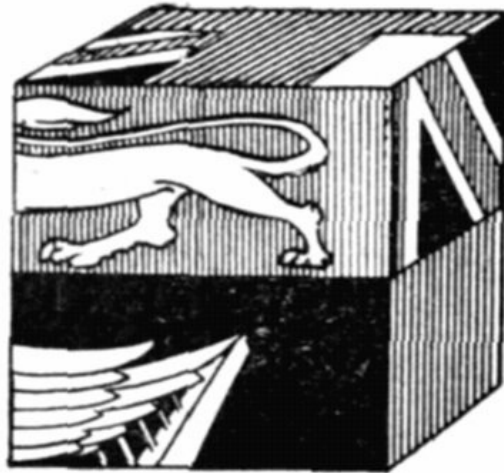

The Flag Puzzle Picture Block is a new and opportune creation. Consists of 12 cubes, papered on four sides, and showing six dissected flag designs in full colors, to be properly put together. Inside cover is color flag designs, with name and use of each. Size of box, 6½ × 5 in. Dozen, \$4 00

Pyramid Blocks.



No. 12/66.

Strong wood shells, covered with handsomely lithographed designs.

Five in nest, builds to

12/66.

height of 16 inches. \$1 60

One dozen in package

12/75.

Eight in nest, builds to

height of 26 inches. \$3 60

One dozen in package

12/76.

Nine in nest, builds to

height of 36 inches. \$8 00

One dozen in package

CHECKER BOARDS.

Nerlich's Own Make.

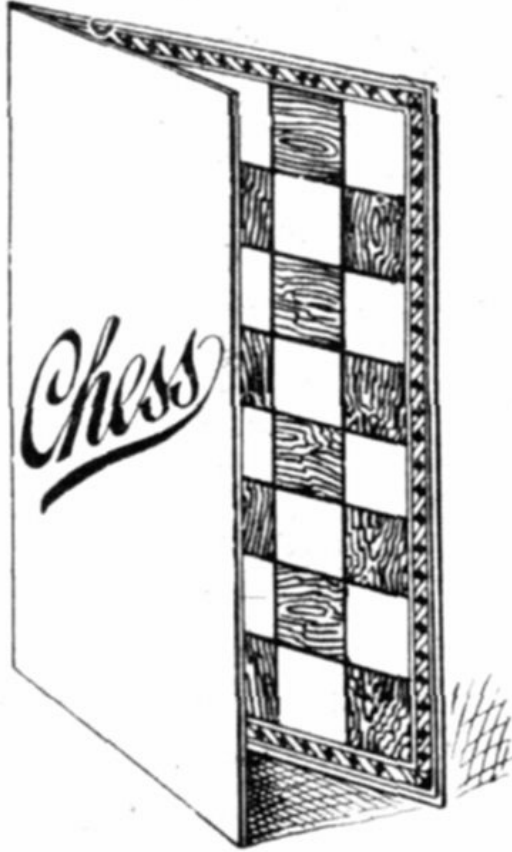

Nos 369/5, 369/6, 369/7.



Nos. A. and B.

Flat Shape.

	Dozen.	
369/4.	Leatherette outside, fancy grained paper inside. Size, 10½ × 10½ inches	\$0 80
369/5.	Leatherette outside, with word "Chess" in gilt letters, fancy grained, brown and white squares. Size, 12½ × 12½ inches	1 20
369/6.	Same as 369/5 but size 13¾ × 13¾ inches	1 50
369/7.	" 369/5 " 15½ × 15½ "	2 20
12/37.	Leatherette, imitation serpent skin back, black and white squares, an extra thick and strong board. Size, 16½ × 16½ inches	7 20

Box Style, complete with Checkers and one Dice Cup.

	Dozen.	
A.	Handsomely lithographed in red, black, cream and gold. Size, 12 × 12 inches	\$3 00
B.	Same as "A" but size 15 × 15 inches	5 00

Checker Men.

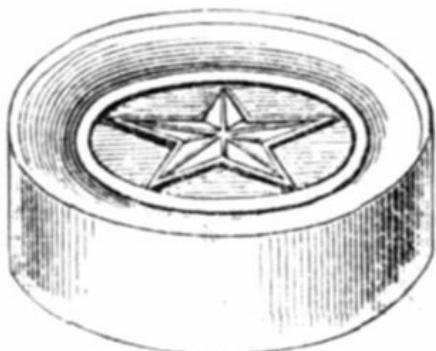

1-inch "Star."



1 1/8-inch "Rex."

"Star,"

"
"

Rex.

Dozen Sets.

1 inch, set of 24 pieces, in paper box	\$0 80
1 1/8 " 30 " " "	1 30
1 1/4 " 30 " " "	1 30
1 1/8 " 30 " embossed and color- traced king head	1 60

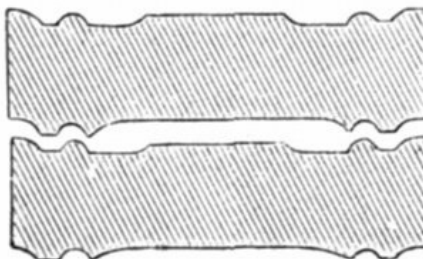

1 1/4-inch enamelled, interlocking.

Dozen.

Enamelled, Interlocking, 1 1/4 inch, put up in attractive box

\$3 60

CHESSMEN.



Boxwood, natural and ebony finish, in white wood boxes with sliding covers.

Dozen Sets.

- 393/9.
- 393/10.
- 393/11.

Height of tallest piece, 2 1/2 inches	\$5 50
" " " 2 3/4 "	8 00
" " " 3 1/4 "	12 00

Dice.

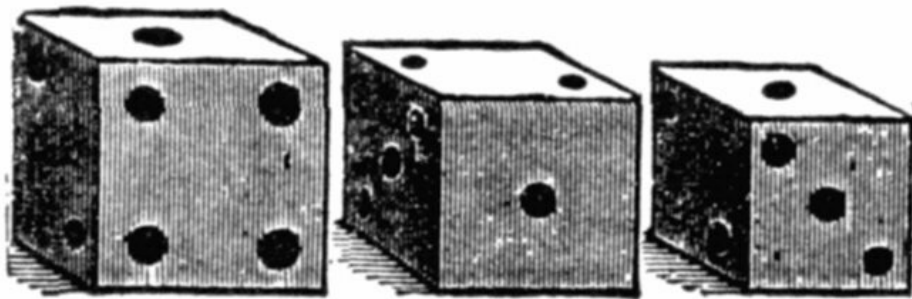

White Bone, square corners.

		Per 100.	
2.		Size, $\frac{3}{8}$ inch, in boxes	\$0 80
4.		of 100	
5.		" $\frac{7}{16}$ " " "	1 20
6.		" $\frac{1}{2}$ " " "	1 50
		" $\frac{9}{16}$ " " "	2 00

Vegetable Ivory, round corners, extra quality.

		Per Gross.	
14/688.		Size inch, 1 dozen in	\$7 20
14/689.		box	
		" $\frac{3}{4}$ " 1 " "	9 00

Poker Dice.

		Dozen Sets.	
$\frac{5}{8}$ inch size, vegetable ivory, round corners, colored faces, 1 set of 5 in a box			\$9 60

Dice Cups.

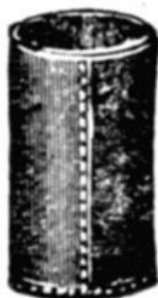

369/12.		Leatherette covered	Gross, \$7 20
22.		Sole leather, extra large	Dozen, 4 00

Cribbage Boards.

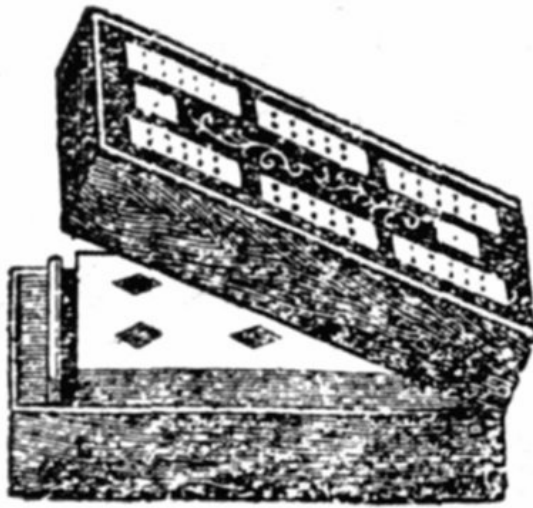

6174.
12/106.
12/107.
12/104.
12/30.
12/101.
12/102.

Dozen.

Flat, hardwood, inlaid	\$1 60
" " " peg holders	2 50
" " " "	3 60
" " bone inlaid	9 00
Box style, inlaid	3 60
" " " plush lined	7 50
" " bone inlaid, very fine	14 40

DOMINOES.

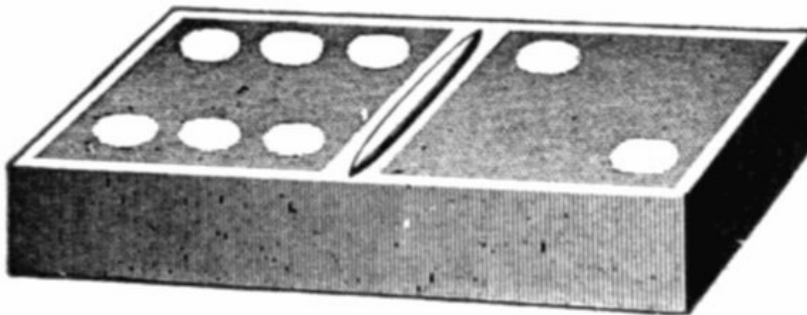

American.

12/56.
—/46.
12/92.
American.
12/93.

Dozen Sets.

White wood, black spots, cardboard box	\$00 80
" " " "	1 30
Black, embossed, white spots, cardboard box	1 60
White, embossed, red spots, cardboard box	1 80
Black, embossed, white spots, fancy box	2 40

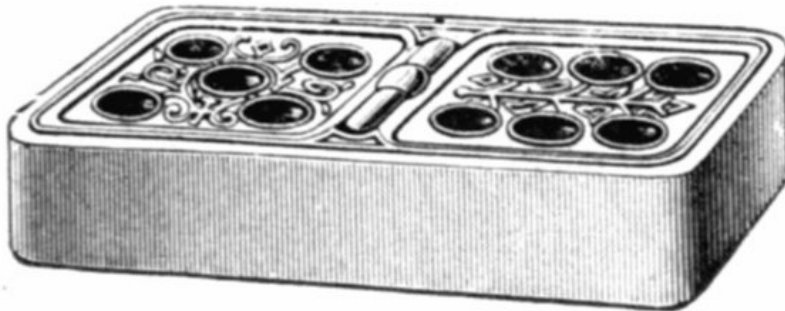

Quarter.

Quarter.
326/3.
12/57.

Dozen Sets.

White, embossed, red spots, cardboard box	\$2 40
White, embossed, red spots, polished wood box	3 60
Black, embossed, white spots, in polished wood lock and key box	3 60

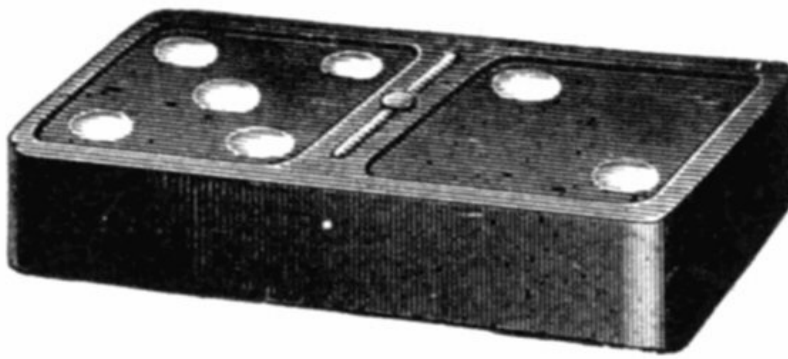

Crown.

Crown.

12/58.

Dozen Sets.

Black, embossed, white spots, cardboard box	\$3 80
Black, embossed, white spots, wood box	4 80

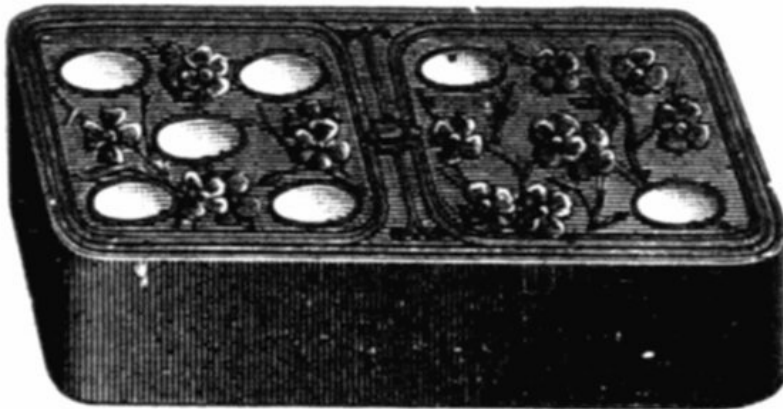

Arabesque.

Arabesque.

Dozen Sets.

Black, embossed, white spots, round corners, in polished wood box with sliding cover	\$8 00
--	--------

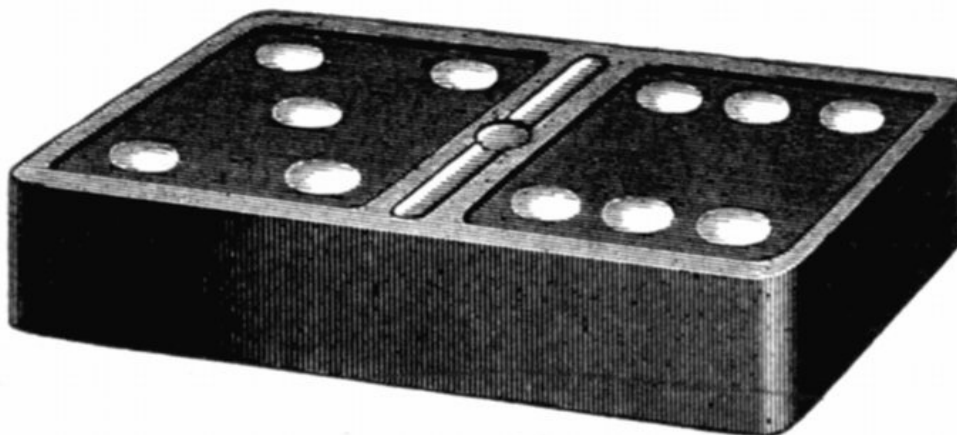

Magna.

Magna.

Dozen Sets.

Black, embossed, white spots, extra large size, in strong cardboard boxes	\$11 00
---	---------

BONE DOMINOES.

White bone rivetted on black wood base, put up in strong hardwood boxes with sliding

cover.

393/14.

393/15.

393/16.

393/17.

Dozen Sets.

Medium size	\$ 4 50
Full size	7 00
Large size, extra fine, in polished boxes	14 40
Similar to 393/16, but face is extra heavy polished bone, and back corners are rounded	21 60

DOUBLE-NINE DOMINOES.

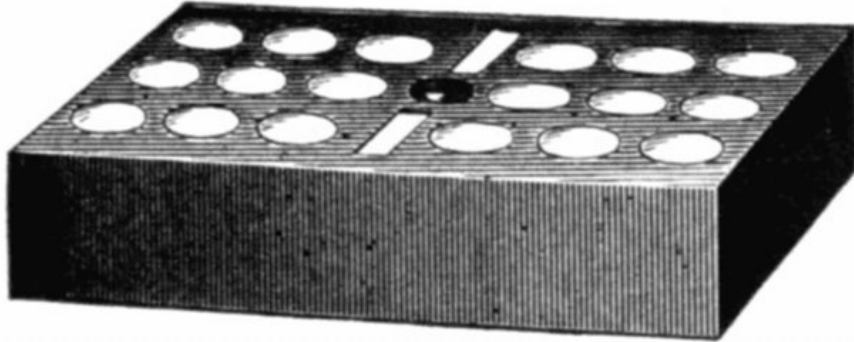

9 "Black."

12/94.

12/83.

9. Black.

Dozen Sets.

Black, embossed, white spots, paper-covered wood box	\$4 00
Black, embossed, white spots, paper-covered wood box	7 20
Black, embossed, white spots, extra fine	16 00

Poker Chips.



Engraved "Golf."

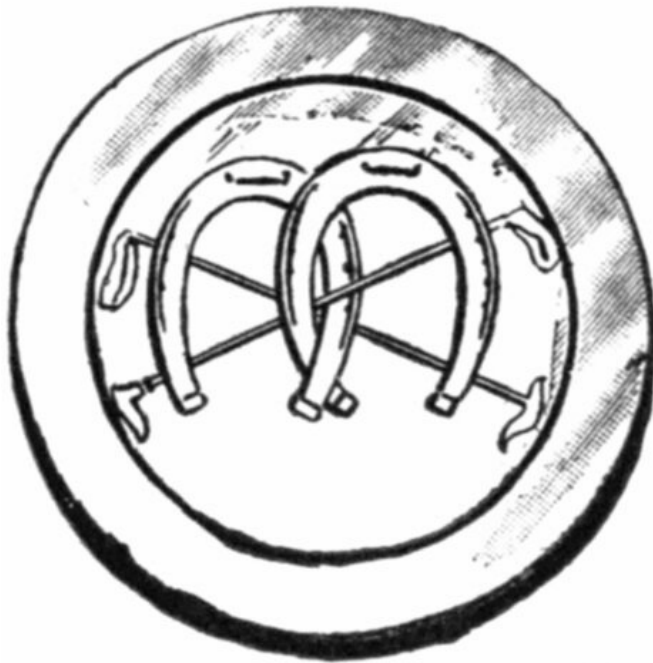

Engraved "Good Luck."

1¼
1⅜
1½

1-12 Engraved, Composition.

Ebonoid.

NOTE.—All Poker Chips come assorted, 50 white and 25 each blue and red in box.

Per 100.

-inch Composition, plain, 100 in box	\$0 60
" " " " "	70
" " " " "	80

This line can be had in
"Golf," "Good Luck,"
"Crown," "Texas
Steer," or "Cap and
Whip," patterns, 100 in
box

1½-inch composition, assorted. "Royal Standard" "Union Jack" flags on one chip; England and Canada on other, 100 in box	\$7 00
--	--------

Playing Cards.



Dozen.

Defiance, a good five

91.
 40. Quebec
 280. Good Luck
 1534. St. Lawrence
 "Owl"
 "Crown"
 33. Apollo,
 Columbia,
 Angel Back,
 Bicycle 1
 National Club,
 No. 35.

cent card	\$0 84
1	50
2	00
2	50
Ivory finish	3 20
Ivory finish	3 50
aluminum finish	4 00
French size, aluminum surface	4 50
Ivory finish	4 20
4	30
Superior ivory finish, expressly for club use	5 00
"	
Finest ivory finish, a first-class card "	5 50

CARD GAMES.



1899/1. Assortment

Dozen.

1. Lost Heir,

includes "Snap," "The House that Jack Built," "Peter Coddles," "Authors," "Golden Locks," and "Old Maid," an extra large and fine edition for a five cent game; size, 4 1/4 x 3 1/4 inches; 1 doz. assorted in a pkg.

1. Nations,

Canadian edition; a low priced edition of this popular game that will meet with a large sale; size of box, 5 x 4 inches; 1/2 doz. in package

2. Old Maid,

a fine ten cent edition of this old favorite, a complete set of 52 full sized cards in box, 5 x 4 in.; 1/2 doz. in pkg.
 size, 5 x 4 in.; 1/2 doz. in pkg.



2. **Lost Heir,**

2. **Nations,**

Dozen.

Canadian Edition; fine quality fancy back cards, put up in a strong telescope style card case

\$3 60

very fine fancy back cards, lithographed faces, put up in telescope style card case

3 60

FIRESIDE EDUCATIONAL GAMES.

includes "Strange People," "Flags," "In Castle Land,"

100/1120. Assortment

"Population,"
"Arithmetic Play,"
"Nationalities," and
"Young Folks Favorite
Authors," all gotten up
in that handsome style
that has brought this
series into such
popularity

3 60

POPULAR GAMES.

PARCHESSI.

Dozen.

1525.

Square board in
handsome lithograph,
imitation cloth box,
with word "Parchessi" \$ 1 50
on top of box. Size,
7½ × 7½ inches; 1 doz.
in package

369/1.

Folding board; size,
10¾ × 10¾ inches,
with separate box
containing bone
counters, 2 dice and
dice cup 2 50

369/2.

Similar to 366/1, but
size, 12¼ × 12¼, and
has 4 bone dice and 4
dice cups 4 00

369/3.

Same as 369/2, but
size, 18 × 18 in. 8 00

HALMA.

369/10.

Folding board; size,
10½ × 10½ inches, in
box complete with men \$4 00

369/11.

Same as No. 369/10,
but size, 14 × 14
inches 8 00

CUCKOO.

321.

A new and handsome
edition of this well-
known Society game.
It'll be a big seller at
the price; size, 6¼ × 5
in. \$2 40

LOTTO.

747.

Cardboard box. \$1 60

750. Trunk style.

Paper covered wood
box trunk; size,
6¾ × 4 × 2½ inches 4 00

750/1.

As above. Size,
8 × 5 × 3 inches 8 00

750/2.

As above. Size,
10 × 6 × 3¼ inches 16 00

PICTURE LOTTO.

1738/1.

A very attractive and
popular style. Instead
of numbered cards and
centres, has object
pictures 4 00

ASSORTMENT OF POPULAR BOARD GAMES.

Size, 15 × 15 inches

Extra good value, being very handsomely lithographed in numerous colors. This assortment is an "all-popular" collection, including such fascinating games as "India," "Topsy' Turvy" "Mother Goose," "Wide Awake" and "Ups and Downs"

\$4 50

STEEPLE CHASE.

426.

A large and handsome edition. Size, 20 × 10¼ inches

\$4 50

BICYCLE RACE.

1192.

An exciting game. Size, 10¾ × 5½ inches

\$1 50

TIDDLEDY WINKS.

369/8.

Handsome box, bone flips; size, 4½ × 3 inches

\$1 60

369/9.

Handsome box, bone flips; size, 5½ × 5½ inches

4 00

TOY BOOKS.



4/9. ASSORTMENT

Gross.

composed of four different series, and includes *twenty-four popular stories*. Each book has several full-page illustrations in red and black. ½ gross packages contain 6

\$2 20

1100. ASSORTMENT.

SOLDIER SERIES.

LIFE OF QUEEN VICTORIA.

17. IVORY SERIES.

12/15. PLEASEWELL SERIES.

SUNBEAM SERIES.

kinds, 1 gross packages 12 kinds, and 2 gross packages 24 kinds

Size 5½ × 7½ inches. 10 pages text and pictures; colored covers. Three kinds A B C and story books 2 40

Three kinds. Size 5¾ × 7½ inches; 10 pages, six of which are in full colors 4 80

An attractively illustrated little book with four full color pages, giving in child words the story of our Queen's life. Size 5¾ × 7½ inches 4 80

Size 5 × 7¾ inches, 10 pages and covers, four pages in numerous colors and the text is illustrated throughout with one color pictures. Titles: Idle Doggies, The Piper's Son, Picture Thoughts, and Farm and Garden 6 00

Twelve kinds. Size 5½ × 7¾ inches, 10 pages, 4 full page color illustrations. 2 dozen packages 6 50

Size 7 × 8½ inches. Twelve kinds, big value, A B C and picture story books. Each book contains four pages in full colors. 1 dozen assorted in package 9 60



33. SUNSHINE SERIES.

Dozen.
Size 6½ × 9 inches,
contains four colored
pages beside the
covers, three full-page
black pictures and
three pages reading.
Series contain
Cinderella, Three

\$0 84

38. CHIMNEY CORNER SERIES.

Bears, Cock Robin, The
Frog Who Would A-
wooling Go, The Three
Little Pigs, and the
Silly Hare. 1 dozen in
package
Size 7½ × 9½ inches,
contains 32 pages,
each of the Old
Standard Fairy Stories
profusely illustrated in
black

1 20

WONDER SERIES. Untearable.

Mounted on Linen.
Twelve popular kinds
of A B C and picture
story book. Each book
contains four pages in
full colors

1 60

267½. PLEASEWELL SERIES. Untearable.

Mounted on Linen. Six
popular titles. Contains
10 pages, printed in
colors. 1 dozen
assorted in package

1 70

117. YOUNG FOLKS' SERIES.

Size 8½ × 14½ inches,
14 pages, four of which
are full page colored
illustrations. Series
contains Cinderella,
Puss in Boots, The
Three Bears, Red
Riding Hood, Babes in
the Wood, and Jack
and the Bean Stalk

1 80

119½. MOTHER GOOSE SERIES.

Size 8½ × 10¾ inches,
14 pages with
numerous colored
illustrations. Series
contains Curly Locks,
Little Jack Horner,
Little Miss Muffet, and
Polly put the Kettle on

2 00



1113. ASSORTED.

163A. BIG PICTURE SERIES.

143/144. MOTHER GOOSE.

151/156. ASSORTED.

150/206. ASSORTED.

220. ONE, TWO, THREE, FOUR,

Dozen.

Four kinds. Size 9 × 11 inches. Large and handsome books, each containing four pages in full colors. Titles: "Old Mother Hubbard," "Cinderella," "Funny Animals at Play" and "Mother Goose." 1 dozen assorted in package \$ 2 40

Size 9 × 10½ inches, 14 pages, six full-page color illustrations. **Twelve Popular Titles** are in this series. 1 dozen assorted in package 2 40

Two kinds. Mother Goose's Chimes and Mother Goose's Rhymes, each contains 64 pages with alternate red and silver grey top and margin illustrations throughout. Is also illustrated throughout with black pictures "A. B. C. of Birds," and "Our Baby's A. B. C." 3 00

Size 10 × 12 inches. In full colors throughout "By Land and Water," "Frogs and Mice," and "The Brave Tin Soldier." Size 10 × 12 inches; 14 pages all in full colors 3 60

size 10 × 12 inches, 14 pages, twelve of which are illustrated in colors. This popular edition contains the old favorite nursery jingles with attractive illustrations for each 4 00

SHAPED TOY BOOKS.



35. TEA PARTY SERIES.

Dozen.

Size 4 $\frac{3}{4}$ x 5 $\frac{3}{4}$ inches.
14 pages, 4 pages and
covers in full colors.
Series includes "Puss
in Boots," "The Tea

\$ 0 80

34. TOPSY SERIES.

Party," "Peeps at Piggy," and "The Funny A. B. C." 1 dozen assorted in package Size 4 x 8¾ inches. 10 pages, 4 of which are full page colored illustrations. Series includes "Topsy,"

84

61. ASSORTMENT.

"Dolly's Adventures," "The Last of the Mohicans," and "Dolly at the Seaside." 1 dozen in package Seven kinds. Size 5½ x 10½ pages, 6 in full colors. Series includes "The Owl and the Fox," "Robber Kitten," "Ten Little Niggers," "Simple Simon," "Little Mother Goose," and "All About Santa Claus." 1 dozen assorted in package

1 60

Linen Books.

Dozen.

265. LITTLE A. B. C.

Printed on strong linen. Size 4 x 5¾ inches. Text and illustrations in two colors, colored cover

\$ 0 80

258. LITTLE LINEN SERIES.

12 pages printed in black and red on strong linen. Series contains "Apple Pie A. B. C.," "Baby's Own A. B. C.," "Little Learner's A. B. C.," and "A. B. C. of Animals"

90

270. MERRY ALPHABET SERIES.

Printed on linen. Size 8½ x 10½ inches. 14 pages, 6 in full colors. Very handsome covers. Series includes "Jolly Animals A. B. C.," "Apple Pie A. B. C.," and "Merry Alphabet"

4 00

HALF-BOUND BOOKS.

Full color lithographed and varnished board covers; cloth binding. All are profusely illustrated.



Little Ferryman Series.

Little Pet Series.

907. Assortment.

908. Assortment.

Happy Hour Series.

Dozen.

Six kinds little folks story books, containing 48 pages. Size, $8\frac{1}{4} \times 10\frac{1}{2}$ inches; 1 dozen assorted in package \$2 40

Six popular 80 page story books. Colored frontispiece. Size $8\frac{1}{4} \times 10\frac{1}{2}$ inches; $\frac{1}{2}$ dozen assorted in package 3 20

Six popular titles. Contain 128 pages fully illustrated short stories. Colored frontispiece. Size, $7\frac{1}{2} \times 10\frac{1}{4}$ inches; $\frac{1}{2}$ dozen assorted in package 4 00

Three titles:—"Alice's Adventures in Wonderland," "My Little Friend," and "Anderson's Fairy Tales." Each book contains 176 pages of text and illustrations. Colored frontispiece. Size, $7\frac{1}{2} \times 10\frac{1}{4}$ inches; $\frac{1}{2}$ dozen assorted in package 5 50

Four kinds, containing 192 pages of selected juvenile story reading and illustrations. Colored frontispiece. Series comprises:—"Golden Moments," "Picture Land," "Daisies and Darlings," and "Happy Hours." Size, $8\frac{1}{4} \times 10\frac{1}{2}$ inches; $\frac{1}{3}$ dozen assorted in package 6 00
Titles:—"Young Folks'

910. All Over the World Series.

Best Story Book,"
 "Holiday Pastimes,"
 and "All Over the
 World." Each
 containing 240 pages.
 Colored frontispiece.
 Size, 7½ × 10¼ inches;
 ⅓ dozen assorted in
 package

7 20

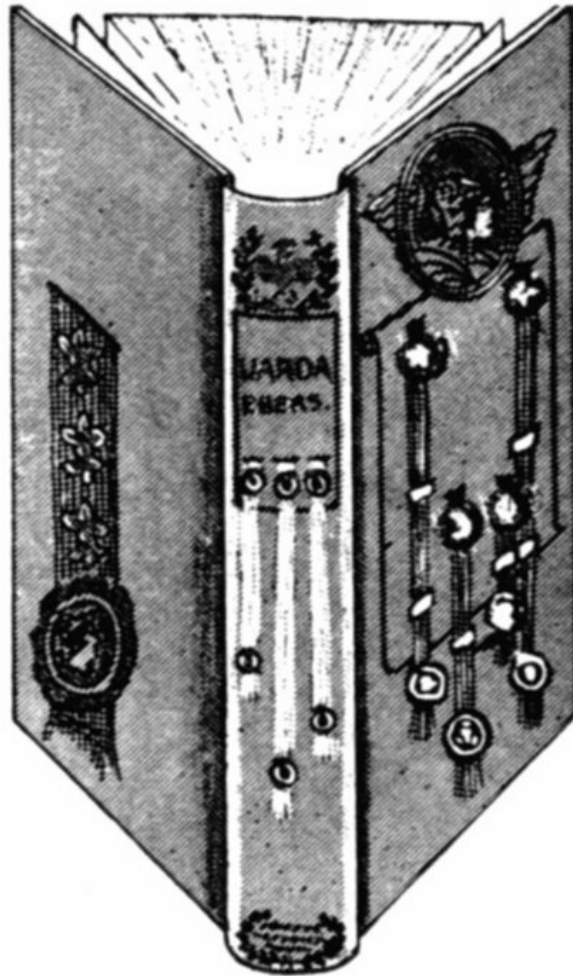

784. New Chatterwell

Story Book. Contains
 280 pages of these well
 known and popular
 juvenile stories.
 Colored frontispiece.
 Size, 8½ × 10½ inches;
 ⅓ dozen in package

9 60

Knock-about Club Series.

Series comprises nine
 different books, each
 complete in itself, and
 describing the various
 interesting and
 adventurous travels of
 this famous club. Each
 book contains 240
 pages and has a host of
 illustrations. Size,
 6¾ × 8½ inches

9 60

Old Mother Goose.

Size, 7 × 9 inches. 316
 pages, embracing a
 complete collection of
 the writings, tales,
 jingles and rhymes of
 Mother Goose. Has
 numerous full page
 color illustrations

12 00

Grimm's Fairy Tales.

A very handsome and
 complete edition of this
 popular young folks
 reading. Finely
 illustrated and with
 colored frontispiece.
 Contains 276 pages.
 Size, 8½ × 10½ inches

13 00

821. Anderson's Fairy Tales,

complete. Same style
as 817. Contains 316
pages 13 00

814. Alice in Wonderland.

190 pages; printed in
red and black on fine
quality paper. Size,
8½ × 10½ inches 13 00

917. Robinson Crusoe.

A new and very
handsome edition. 415
pages. Size, 7¼ × 9½
inches 13 00

TIN TOPS.



No. 367/21.

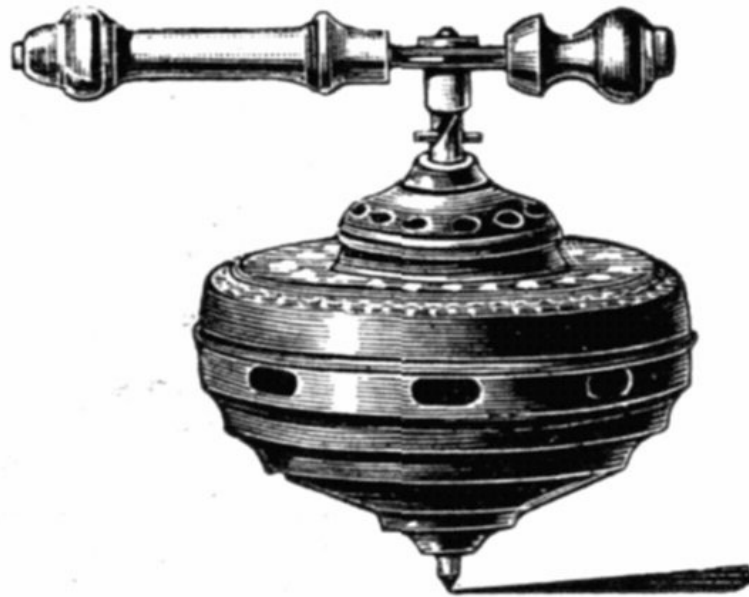

No. 4342.

Humming. Embossed and japanned in colors.

19/4.
19/5.

Dozen.

Height, 4½ inches. 1	\$0 60
dozen in box	
" 5½ " 1 " "	80

Musical. Embossed and japanned in colors.

367/21.
14/334.
14/335.

Dozen.

Height, 6 inches. 1	\$1 60
dozen in box	
" 8½ " 1 " "	3 00
" 9 " ½ " "	3 60

Choral, as above, but changing tune.

367/15.
367/20.
14/592.

Height, 6½ inches.	\$4 00
Each in box	
" 7 " " "	8 00
" 8½ " " "	9 60

Patent wind, as in cut. Musical.

4342.

Height, 5 inches. ½	\$4 00
dozen in box	

Automatic Spring Wind.



No. 393/23 & 24.

Dozen.

393/23.
 393/24.
 393/24½."
 393/25.
 3547.

Diameter, 2 inches. 1 \$1 70
 dozen in box
 " 2½ " 1 " " 2 40
 3 " ½ " " " 3 20
 Musical, 3 " ½ " " 4 00
 " 5½ " Each in 12 00
 box

RATTLES.

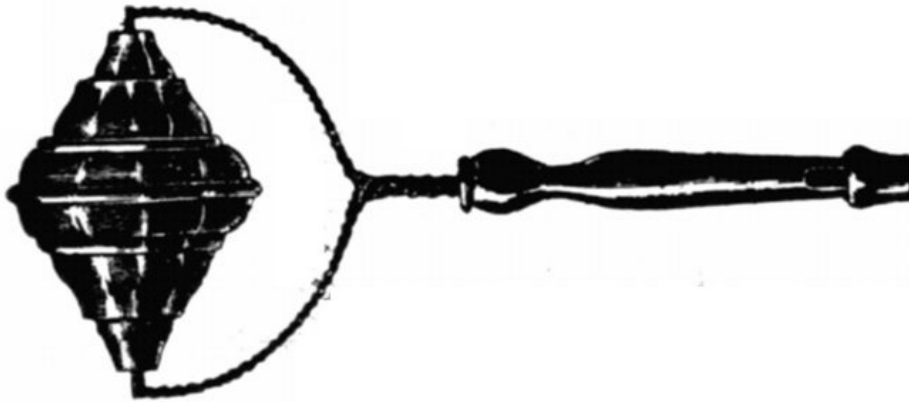

No. 19/19.

19/19.
 14/671.
 19/22.
 19/21.

Dozen.

Japanned in colors;
 natural wood whistle
 handle. Length, 7 \$0 60
 inches. 1 dozen in box
 As above but painted
 handle. 1 dozen in box 70
 Japanned in colors;
 natural wood handle,
 bone ring. Length, 8 1 20
 inches. 1 dozen in box
 Similar to above, but
 painted handle, with
 bells. 1 dozen in 1 50
 package

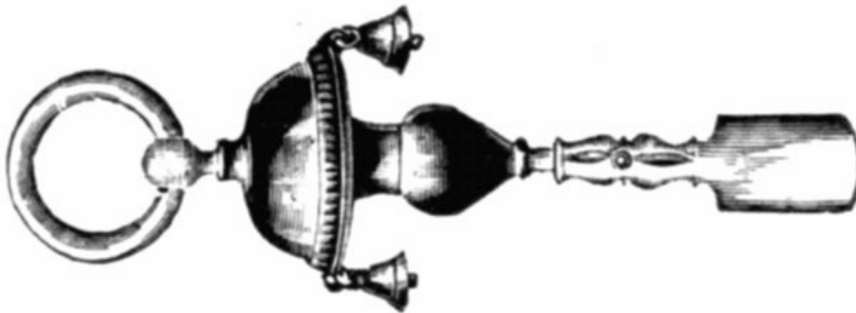

Nickel and bone style.

Nickel Rattles, with bone handles and rings.

19/20.
 367/12.
 367/13.
 367/14.

Dozen.

Length, 5½ inches. 1 \$ 80
 dozen in box
 " 6 " 1 " " 1 60
 " 8 " 1 " " 2 40
 " 8¼ " 1 " " 3 00



Assorted Nickel Rattles, with bone handles and rings.

- 19/23.
- 14/597.
- 14/598.

Dozen.

Six kinds, ½ dozen in box	\$2 40
Three kinds. Each in box	4 00
" " " "	6 00

Sleigh Bell Rattles.



No. 21.

- 17.
- 2R.
- 21.

Dozen.

With 3 bells; black enameled handle. 1 dozen in package	\$0 80
With 2 bells and rubber ring, black enameled handle. 1 dozen in package	1 20
As cut. 4 bells and rubber ring, 1 dozen in package	1 60

TIN TRUMPETS.



Japanned in bright colors; china mouthpieces.

- 19/7.
- 19/8.
- 19/11.

Dozen.

Length, 9 inches. 1 dozen in box	\$0 60
" 11½ " 1 " "	76
" 15 " 1 " "	1 20

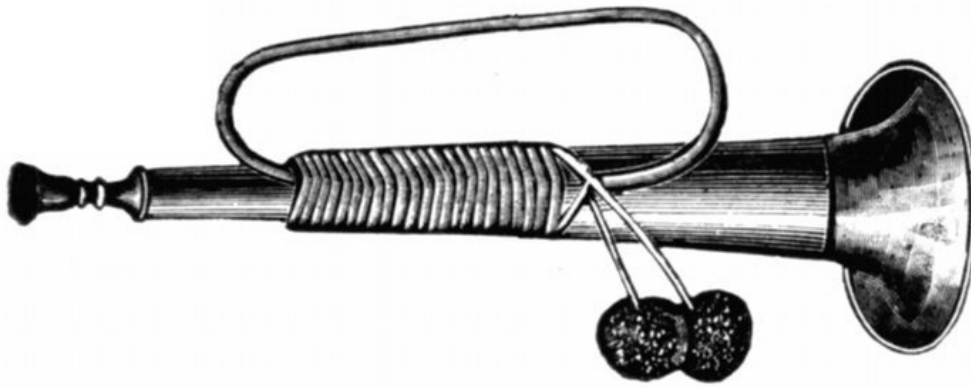

No. 19/17.
Nickel; with fancy cord and tassels.

- 19/9.
- 14/669.
- 19/10.
- 19/12.
- 19/16.
- 19/17.
- 19/18.
- 14/501.

Dozen.

Length, 9½ inches.	1	\$0 70
dozen in box		
" 10¾ "	1 " "	80
Fancy assorted.	1 " "	80
Length, 12 inches.	1 "	1 40
"		
" 12 "	1 " "	1 60
" 12 "	1 " "	2 40
" 15 "	1 " "	3 60
" 18 "	½ " "	7 20

Fancy Shape Trumpets.

Japanned in bright colors.

- 367/16.
- 367/1.
- 367/3.

Dozen.

Length, 11 inches.	1	\$2 20
dozen in box		
" 12½ "	1 " "	3 20
" 16½ "	½ " "	4 00

Tin Horns.



Nickel, same shape as cut; each with fancy cord and tassels.

- 19/13.
- 19/14.
- 19/15.

Dozen.

Length, 10 inches.	1	\$1 60
dozen in box		
" 12 "	1 " "	2 40
" 16 "	1 " "	4 20

Cow Horn Trumpets.

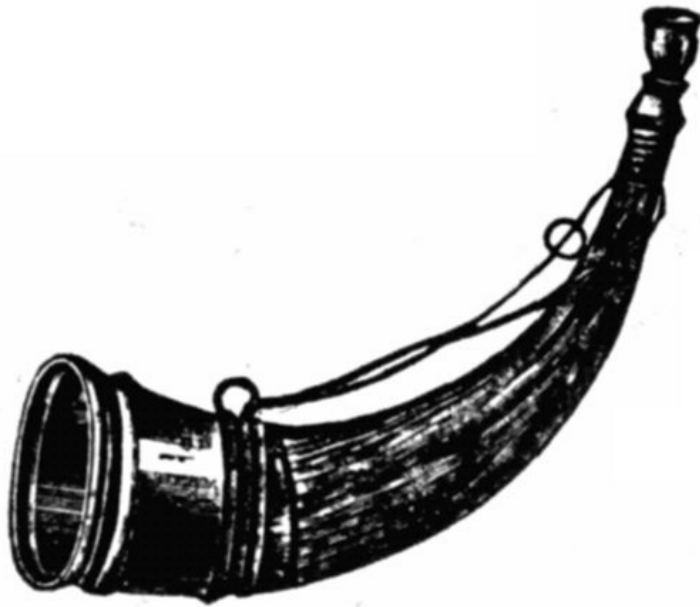

No. 19/2.
Cow horn, nickel or brass ends.

- 19/1.
- 19/2.
- 19/3.
- 14/670.

Dozen.

Length, 6½ inches.	1	\$0 70
dozen in box		
" 9 " 1 " "	1 20	
" 9 " 1 " "	2 40	
" 9½ " 1 " "	4 00	

Toy Cornets.

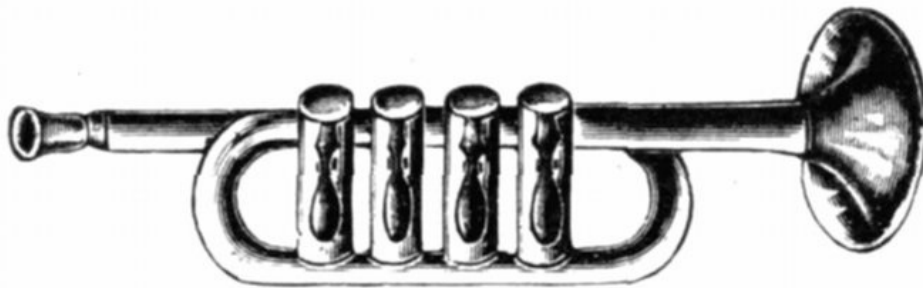

No. 138/16.
Nickel, with leather reed covers. ½ dozen in box.

- 138/16.
- 138/17.
- 138/18.

Dozen.

Length, 10 inches, 4	\$4 00
keys	
" 10½ " 5 "	4 80
" 11 " 6 "	6 50

Toy Trombone.

- 138/10. Nickel

finish, 12 inches long \$3 60

Tin Fish Horns.



- 12.
- 16.
- 18.

-inch size. 1 dozen in	\$0 80
package	
- " " ½ " "	1 20
- " " ½ " "	1 60

Flutes.

- 0. Tin,

Gross.

6¾ inches long \$1 80

Dozen.

4.
 5.
 8.
 2119. Nickel,
 61/196.
 1890.
 21/20. Nickel Flageolet,
 61/763. Celluloid,
 61/364.

"	11½	"	"	\$0 50
"	14	"	"	60
"	16½	"	"	1 00
9¾	inches long			1 20
"	10½	"	"	1 60
"	11½	"	"	2 00
15	inch			3 20
8½	inches long			3 60
"	11½	"	"	8 00

TOY WATCHES.

On Cards.



No. 137/14.



	Dozen.	
137/4.	As cut. Small size, silver finish, with fancy silver bow pin. Each on a card	\$0 50
137/25. Assorted.	6 kinds, silver and gilt; with chains. ½ dozen on card	70
61/693.	Fancy, small size, embossed gilt watch with fob chain, each on card	70
137/3. Assorted.	6 kinds, silver and gilt, with chains. ½ dozen on card	80
137/24.	As cut. Fancy, small size, gilt with chain. Each on a card	80
137/30.	As 137/24, but long chain. Each on a card	1 10
137/27. Assorted.	2 kinds, with fancy colored picture backs, under glass. ½ dozen on card	1 40
137/31.	As above, but finer	1 50
61/5.	Fancy gilt, with long chain. ½ dozen on card	1 60
61/762.	Fancy revolving color dial, gilt, with chain. ¼ dozen on card	2 40

In Boxes.



No. 137/29.



No. 137/9.

137/20.

Gross.

Small size, silver, with
chain. 1 gross in box

\$2 00

Dozen.

137/1.	Medium size, silver, with chain and bar. 1 dozen in box	\$0 50
137/2.	As 137/1, but larger. 1 dozen in box	70
137/9.	As cut. Large size, silver, with chain. Each in a box	1 50
137/29.	Extra large size, closed face, gilt, with heavy chain. Each in box	3 00

KALEIDOSCOPIES.

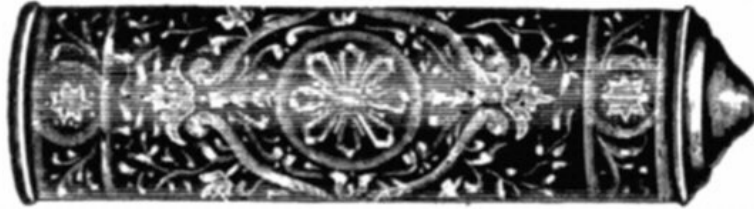

No. 14/514.
In assorted fancy patterns.

	Dozen.	
14/672.	Length, 6¼ inches. 1 dozen in pkg.	\$0 80
14/514.	" 8¼ " 1 " "	1 60
14/43.	" 10 " ½ " "	3 20
46/70.	Nickel, with revolving screw. Length, 7 inches, on polished wood stand 8½ inches high, extra fine, large diameter	12 00

Calliope Whistles.

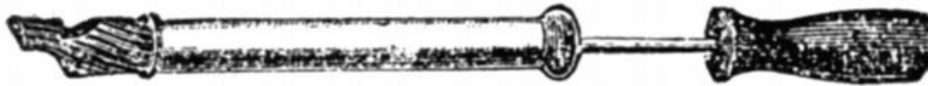

	Dozen.	
393/4.	Tin tube, 3 inches long, with metal mouthpiece, the handle of wood stained black, will play any tune by pulling the rod whilst breathing air through the mouthpiece. A good toy. The calliope whistle is a seller	\$0 60
393/56.	As above, but larger. Entire length, with rod in, is 8½ inches	70

Pea Whistles.

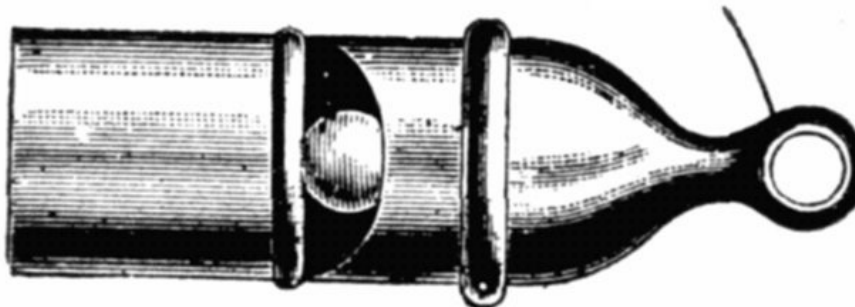

393/55.	Gross. Small size, pewter whistle	\$1 80
61/384.	Dozen. Nickel, with ring. 1	\$0 60

61/385.

61/9.

dozen in package	
" " larger, 1 doz.	70
in pkg.	
Fine nickel, double	1 30
end. 1 " "	

Laughing Camera.



Dozen.

This wonderful little fun maker maintains its reputation as the steadiest selling novelty on the market. 1 dozen in package \$3 00

TOY GUNS.



No. 297/10.

Dozen.

380/6. Pop-Gun,	all wood; fancy painted. Length, 19 inches	\$1 60
268/6.	As 380/6. Length, 30 inches, ½ dozen in package	3 00
297/1. Cap Gun,	stained wood stock, tin barrel; explodes caps. Length, 21 inches; 1 dozen in package	1 60
297/2.	As 297/1, but painted stock. Length, 22 inches	2 40
297/3. Pop Gun,	natural polished hardwood stock, tin barrel; shoots cork, peas or sticks. Length, 25 inches; ½ dozen in package	3 00
297/5.	As 297/3. Length, 29 inches; ½ dozen in package	4 00
297/10. Military Gun,	natural polished hardwood stock, nickelled barrel; metal detachable bayonet. Explodes caps and shoots sticks. Length, 32 inches; ½ dozen in	4 00

297/11.

package
As 297/10. Length, 36
inches

7 50

297/12.

As 297/10. Length 42
inches

9 60



No. 297/4.

Dozen.

297/4. Rifle.

As cut. Dark polished
wood stock, metal grip
and barrel. Explodes
caps and shoots peas
and sticks. Length, 25
inches

\$4 00

297/9.

As 297/4. Length 31
inches

8 00

Swords.

All are with guarded handle and belt.



No. 14/754.

	Dozen.	
14/750.		Solid metal sword, with scabbard japanned in colors. Length, 18 inches; 2 dozen in package \$0 80
14/752.		As above, but length 24 inches; 1 dozen in package 1 60
14/753.		Similar to above, but has bright nickel finished scabbard 2 40
14/754.		A well shaped 26-inch sword in imitation brass scabbard; each on a card 3 60
14/735.		Similar to above, but finer finished and in nickel scabbard; each on card 6 00

Have also finer swords. No. 14/736 at \$8 00 and 14/737 at \$10 80 dozen list.

TOY WHIPS.

NOTE.—Lengths do not include lash. Except where otherwise mentioned all Toy Whips have whistle.

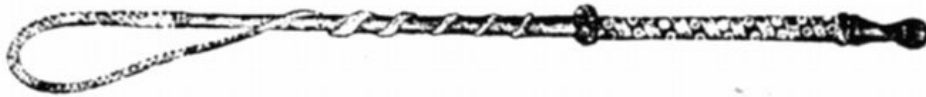

No. 14/673.

Assorted, 1 Dozen on Card.

Fancy colored stocks, plaited lashes.

	Dozen.	
14/511.		Length 21 inches \$0 60
14/673.		" 25 " 1 20
14/674.		" 28 " 1 60
14/675.		" 30 " 2 00

In 1 Dozen Packages.

170/1.		Woven linen covered stock and woven cotton lash. Length 20 inches 80
170/2.		As above, nickel cap and ferrule. Length 20 inches 1 60
170/3.		Bamboo stock 20 inches long and woven cotton lash 1 60
170/4.		Bamboo stock 15 inches long and long plaited leather lash 2 40
170/5.		Woven linen covered stock 28 inches long and plaited leather lash; nickel cap and ferrule 2 40
170/6.		Woven linen covered stock 24 inches long 3 00

and plaited leather
lash

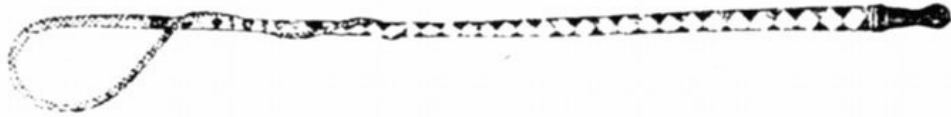

No. 170/7.

170/7.

As cut. Plaited tan
leather stock 30 inches
long and plaited lash 4 00

Dog Whips.

393/48.

Small plaited flexible
dog whip; 1 dozen in
package 80

393/57.

As above, but larger 1 60

393/58.

Fancy white celluloid
handle, fine plaited
stock and lash 3 60

393/59.

As above, but larger 4 00

TOY CANNON.

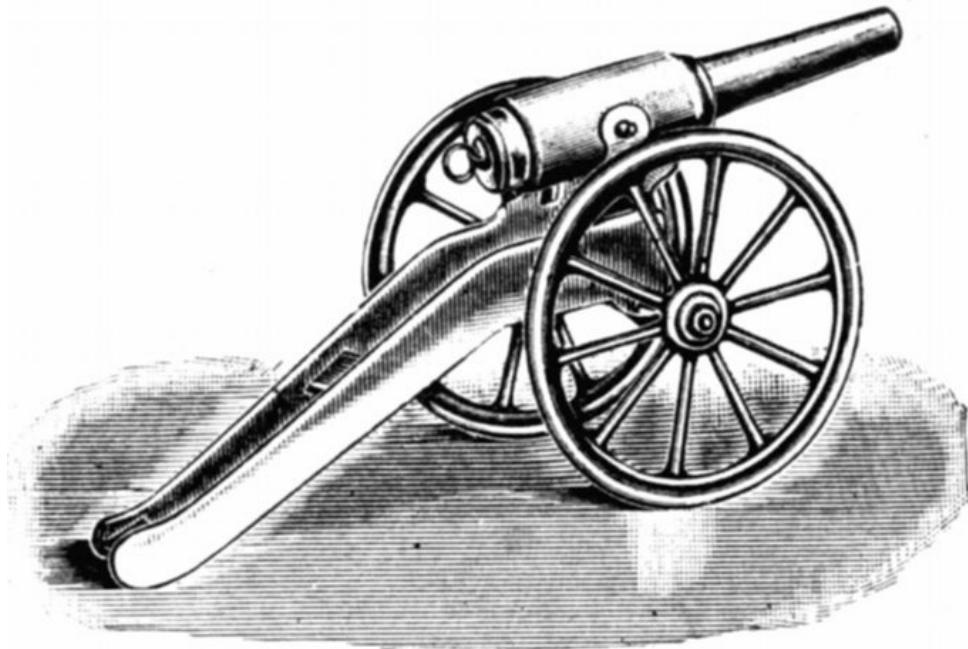

No. 14/743 and 14/744.

Dozen.

14/743.

As cut. Lacquered tin.
Will shoot peas or
other small
ammunition. Entire \$0 80

14/744.

length 5¼ inches;
height 2¼ inches; 1
dozen in package

1 60

As above. Length 7
inches; height 2¾
inches; 1 dozen in
package

14/745.

As above. Length 10½
inches; height 4¼
inches; ½ dozen in
package

3 60

TOY TEA SETS.

CHINA.

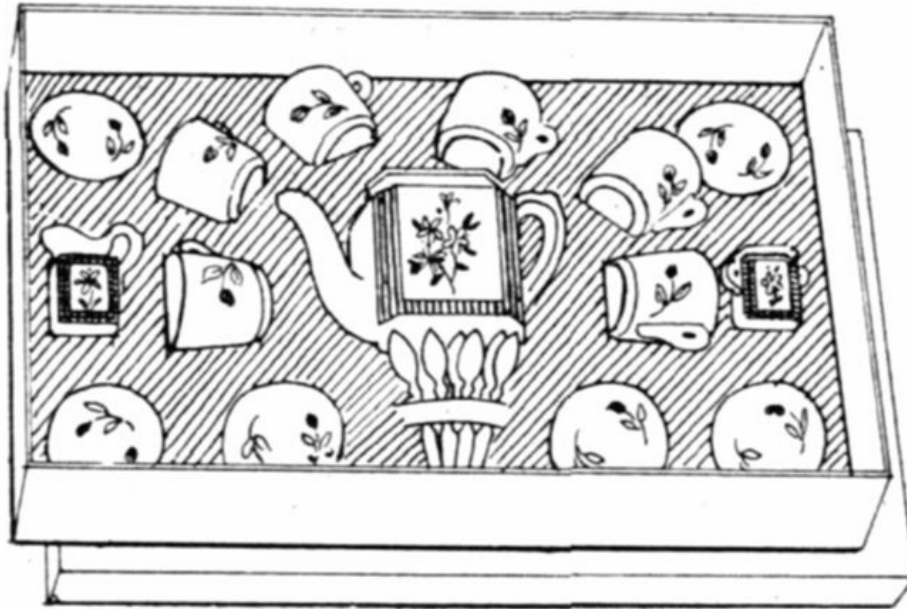

No. 30/1.

All have decoration in colors. Quality and size of the articles is graded according to the price and number of pieces in sets.

Dozen.

9/6.

7 pieces. Size of box,
5¼ × 3¾ inches. 1
dozen in package

\$0 70

9/7.

9 pieces. Size of box,
6 × 4 inches. 1 dozen
in package

84

9/8.

12 pieces. Size of box,
8 × 5½ inches. ½
dozen in package

1 30

9/9.

15 pieces. Size of box,
8½ × 6 inches. ½
dozen in package

1 60

119/101.

23 pieces. Size of box,
9 × 7 inches

2 50

119/102.

23 pieces and 6
spoons. Size of box,
11¼ × 8 inches

3 20

30/1.

As cut. 17 large pieces
and 6 spoons. Size of
box, 11½ × 8 inches

4 00

119/104.

23 pieces and 6
spoons. Size of box,
13 × 10¼ inches

4 50

9/11.

23 large pieces and 6
spoons. Size of box,
14 × 10½ inches

6 50

30/6.

19 large pieces and 6
spoons. Size of box,
14 × 10 inches

8 00

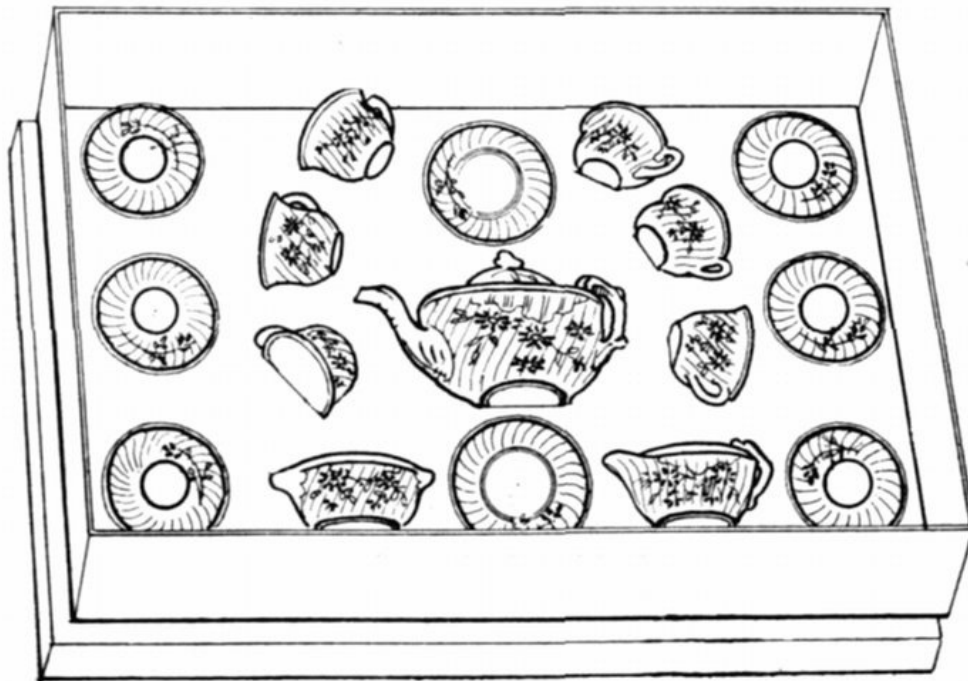

No. 3/103.

3/103.

3/104.

30/32.

3/105.

30/24.

3/106.

3/107.

3/108.

Dozen.

18 large pieces. Size of box, 15½ × 11¾ inches \$8 40

25 large pieces. Size of box, 16 × 12½ inches 12 00

Teapot, 4½ inches high, cream jug, covered sugar bowl, 2 cake plates, and 6 large cups and saucers. Size of box, 20 × 14 inches 16 00

Teapot, 4½ inches high, cream jug, covered sugar bowl, 6 plates 2¾ inches diameter, 6 cups and saucers (1¾ inch cups). Size of box, 21 × 15 inches \$16 80

Same composition as above, but larger pieces. Size of box, 21 × 15 inches 24 00

Extra quality transparent china with burnt in tint and flower decoration. Teapot 4 inches high, cream jug, covered sugar bowl, 6 plates, 2¾ inch diameter, and 6 cups and saucers (1¾ in. cups). Size of box, 21 × 15 inches 26 40

As No. 3/106, but larger; plates being 3¾ inch diameter and cups 2 inch diameter. Fancy rack box, 21 × 15 inches 42 00

Fine quality china set; five o'clock tea size. Consists of teapot 6½ inches high, cream jug, covered sugar bowl, 6 cups and saucers (2½ inch cups). The decoration is a beautiful flower design on burnt in shaded tint. Size of box, 24 × 17 54 00

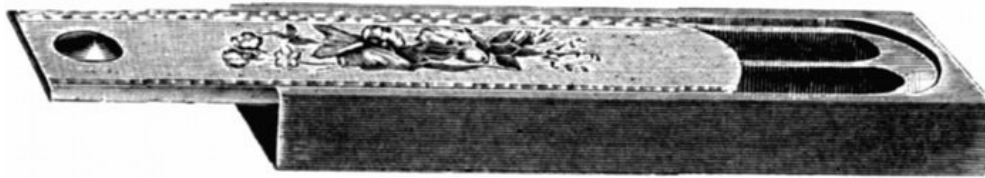
PENCIL BOXES.**Dozen.**

299/1.	Polished maple, 1 dozen in package	\$0 80
299/11.	Highly polished maple, the cover when pulled out releases top half of box and allows it to swing to one side, disclosing a lower section divided into three compartments, 1 dozen in package	1 60
299/12.	as 299/11, but larger and has more compartments. ½ dozen in package	2 20
299/13.	A large size three compartment box polished in brilliant green color with fancy top design in gold and colors, 1 dozen in package	2 40

ROLL TOP.

299/8.	Polished wood, three compartments. Top is made in small sections that roll out of sight around the end of the box as the bottom slide is pulled out. 1 dozen in package	\$1 60
---------------	---	--------

HINGE COVER, LOCK and KEY.

299/6.	Stained wood, hinge cover, lithographic picture on top, three compartments, lock and key. 1 dozen in package	\$0 70
14/677.	Finely polished three compartment box; imitation inlaid top in assorted patterns; hinge cover; lock and key. Three fittings. 1 dozen in package	2 40
14/678.	Highly polished grooved tray box; inlaid hardwood veneer tops in assorted patterns; hinge cover; lock and key. Fitted with large screw top ink bottle and three other fittings	3 60

DRAWING SLATES.



No. 12/8.

Whitewood frames, ground and polished glass. All with six outline model pictures and one colored picture, except 12/5, which has outline pictures only.

12/5.

12/6.

12/7.

12/8.

12/9.

12/10.

As above, but blackboard back.

12/12.

Combination Drawing Slates, with Paint Sets.

12/50.

12/51.

12/52.

Dozen.

Size 5½ × 4½ inches.	2	\$0 60
doz. in pkg		
" 6¼ × 5 "	2 "	80
" "		
" 7¼ × 6¼ "	1	1 20
" "		
" 8¼ × 7¾ "	1	1 60
" "		
" 10¼ × 8¼ "		2 40
½ " "		
" 11½ × 9½ "		2 80
½ " "		
" 11½ × 9 inches,		
has pencil and two		
colored crayons in		
frame		4 00

Dozen.

Size 5¼ × 5 inches,		
separate drawing slate		
and moist color paint		
box, containing 12		
colors and brush.	1	\$1 60
dozen in package		
Size 6¾ × 6 inches,		
otherwise same as		2 20
12/50		
Size, 9½ × 8 inches,		
similar to 12/50, but		
has 16 moist colors, 6		
dry colors, 2 cups and		
brush, ½ dozen in		
package		3 60

School Crayons.



Daisy.
14/158.

14/159.

1/2.

Rainbow

Radiant

14/160.

Colored Chalk,
Colored Chalk,

Gross.

4 Colors \$2 00
6 Colors 4 80

Dozen.

8 oil crayons and holder. Extra value 70
14 Colors in wood barrel box 76
wax artist crayons, 7 colors. 3³/₄ inch size 80
wax artist crayons, 12 colors; 3³/₄ inch size 1 50
Artist oil crayons, 6 colors, paper covered 1 50

Gross.

small, 7 colors \$1 80
large, 6 colors 1 80

PAINT BOXES.

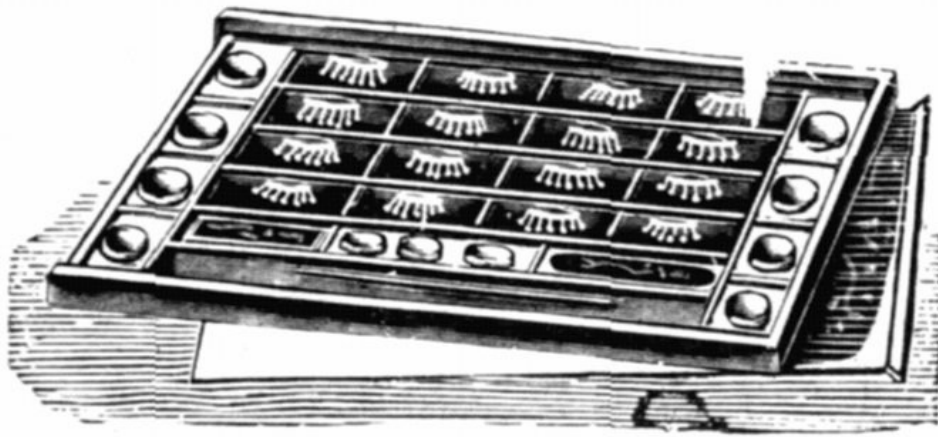

Wood Box, Stained Edge, Chromo on Top.

326/15.

326/16.

326/17.

326/18.

326/19.

Gross.

15 Colors, 2 cups and brush. Size, 7 × 4 inches \$7 20

20 Colors, 2 cups and brush. Size, 7½ × 4¾ inches 9 60

Dozen.

16 Colors, 4 cups and brush. Size, 9 × 5¼ inches 1 20

16 colors, 4 cups and brush. Size, 11¾ × 5¾ inches 1 50

12 **Moist colors**, 3 dry colors, stick of Indian ink, 2 cups and brush. Size, 7½ × 4¾ inches 1 20

Moist Colors in Polished Top Boxes.

12/78.

12/79.

Dozen.

16 Colors Size, 7 × 4¼ inches \$1 60

16 " " 8½ × 4¼ " 2 40

Fine Water Colors, in Highly Polished Wood Boxes.

12/80.

12/81.

12/82.

Dozen.

16 Colors, 2 tubes. Size, 9 × 4 inches, 2 dishes and brush \$4 00

20 Colors. Size, 11 × 5¾ inches, 4 dishes and fine brush 8 00

30 Colors. Size, 10½ × 7 inches, 6 dishes and 2 fine brushes 12 00

Moist Colors, in Japanned Tin Boxes.



6191.

Dozen.

8 Colors and brush. Size, 3½ × 2½ in. \$0 68

6190.
6188.
12/90.
12/91.

15	"	"	"	4 × 2½	"	1 40
20	"	"	"	6¼ × 2½	"	2 50
12	"	"	"	6½ × 3	"	4 00
18	"	"	"	7¼ × 3¼	"	8 00

TOY TIN TEA SETS.

On Trays.



No. 356/1.

365/6.

Dozen Sets.

Similar to above cut. Consists of teapot 3¾ inches high, cream jug, 2 cups and saucers (size of cup 2 inches), small dish and tray, size 8¼ × 6 inches. All in fancy lithograph decoration. Each set in a box

\$ 3 20

356/1.

As cut. Height of teapot is 4 inches, of cups, 2¼ inches. Size of tray, 9 × 6¼ inches. Fine lithograph decoration with miniature scene pictures in variety of colors. Each set in a box

4 00

Tin Plates.

355/27.

Dozen.
Child's tin plate;
lithograph decoration.
Diameter 6 inches. 1
dozen in package \$0 70

355/25.

Fruit plates; lithograph
fruit decoration. \$ 80
Diameter 6½ inches. 1
dozen in package

Tin Cup and Saucer.

355/33.

Lithograph decoration;
size of cup, 2½ × 2½
inches. 1 dozen in
package \$0 80

355/26.

Child's tin cup, saucer
and plate set. Diameter
of plate, 6 inches. Flat
shape cup, 2½ inch
diameter. 1 dozen sets
in package 1 40

Tin Toilet Set.

356/30.

Dozen Sets.
Toilet table set,
consisting of large
tray, size 9 × 6 inches,
small oval hairpin or
trifle tray, one large \$3 60
and two small colored
boxes. Flower
decoration in gold and
color. Each set in a box

SAND PAILS.



No. 356/22.

365/4.

356/22.

355/31.

Dozen.

Japanned in bright colors with gold stripes; flat tin handle. \$0 80
 Size, 4 × 4 inches. 1 dozen in package
 As cut. Lithographed figure decoration. Size, 84
 3¼ × 3¼ inches. 1 dozen in package
 Similar to above.
 Lithographed figure decoration; wire handle. Size, 5¼ × 5 1 50
 inches. 1 dozen in package

Sand Set.

355/36.

Dozen Sets.

Consists of sand pail 3¼ inches diameter, watering can 4 inches high, sand scoop, mug, crimped dish and mound shape mould. \$4 00
 Lithograph figure decoration. Each set in box, size 8½ × 7¼ inches

Toy Watering Cans.



No. 356/35.

356/25.

356/35.

Dozen.

Lithographed figure decoration. Entire height, 5 inches. 1 \$0 84
 dozen in package
 Japanned in bright colors, flower decoration. Entire height 6 inches. ⅔ 1 60
 dozen in package

DOLL BATH TUBS.



No. 14/694.

Same shape as in cut but without stand. Natural tin inside, fancy decorated outside.

355/37.

Dozen.

Length, 5 inches. 1 dozen in package \$0 70

356/28.

" 6 $\frac{3}{4}$ " 1 " " 1 30

As cut, on stand with pail and with **Bathing Doll**. Blue enamel outside, white enamel inside.

Dozen.

14/694.

Length, 6 $\frac{1}{2}$ in. Height, 4 $\frac{3}{4}$ in. $\frac{1}{2}$ doz. in pkg. \$4 00

14/695.

" " 9 " " 6 " $\frac{1}{4}$ 7 20

14/696.

" " 10 $\frac{1}{2}$ " " 6 $\frac{3}{4}$ 11 00

14/697.

" each in box " 12 " " 7 $\frac{1}{2}$ " 14 40

Sitting Baths.

Round shape, with low front and high back. Blue enamel outside and white enamel inside. Each with **Bathing Doll**.

Dozen.

14/699.

Height, 2 $\frac{3}{4}$ inches. 1 dozen in package \$2 40

14/698.

" 4 $\frac{1}{4}$ " $\frac{1}{2}$ " " 3 60

Doll Wash Stands.



No. 14/732.

14/732.

14/733.

14/44.

14/734.

Dozen.

As cut. Tin stand finished in white. Has mirror, gauze drape and 4-piece china toilet set. Height, 6 inches. 1 dozen in package \$1 70

Similar to above but 7½ inches, and has two china toilet sets. ¼ dozen in package 4 00

Similar to 14/732 but instead of gauze drape has larger mirror back. Height, 7 inches. ½ dozen in package 4 00

As cut 14/732 but double style having 2 complete toilet sets. Height, 8½ inches. Each in a box 8 00

TOY TIN SETS.

Finished in white enamel with tasteful decorations in blue.

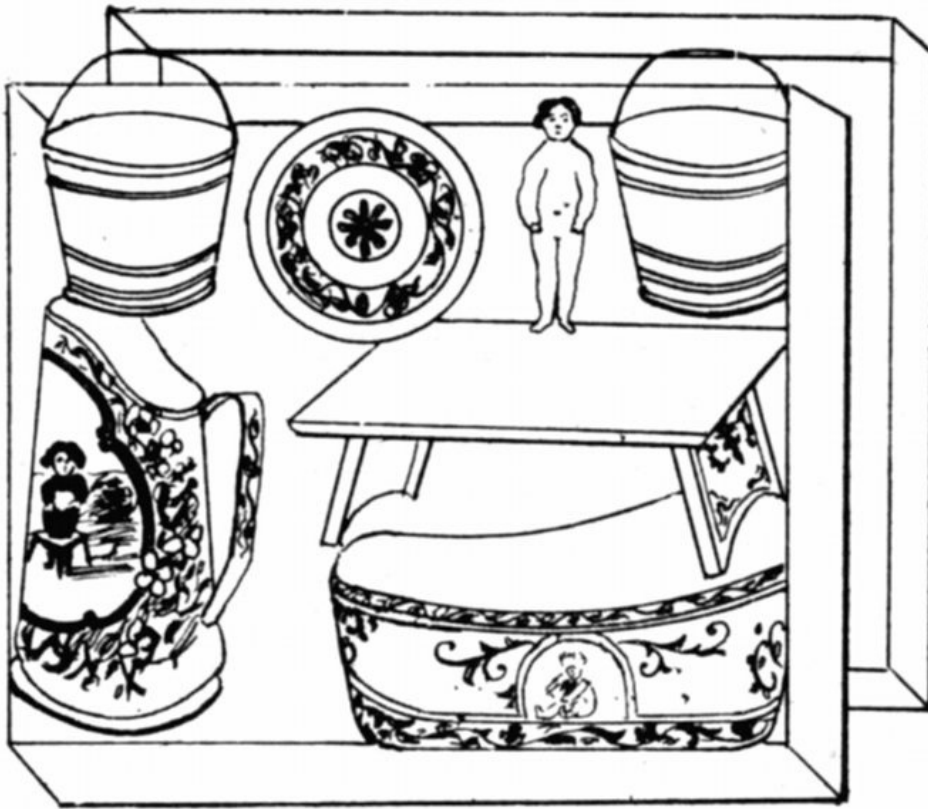

No. 355/21B.

Dozen Sets.

355/21B.

As cut. Bath set consisting of bench, bath tub, two pails, basin, large jug and Bathing Doll. Each set in a box. Size, $8\frac{1}{2} \times 7\frac{1}{4}$ inches \$4 00

355/24B.

Wash set consisting of bench, tub, wash board, large jug and pail. Each set in box. Size $8\frac{1}{2} \times 7\frac{1}{4}$ inches 4 00

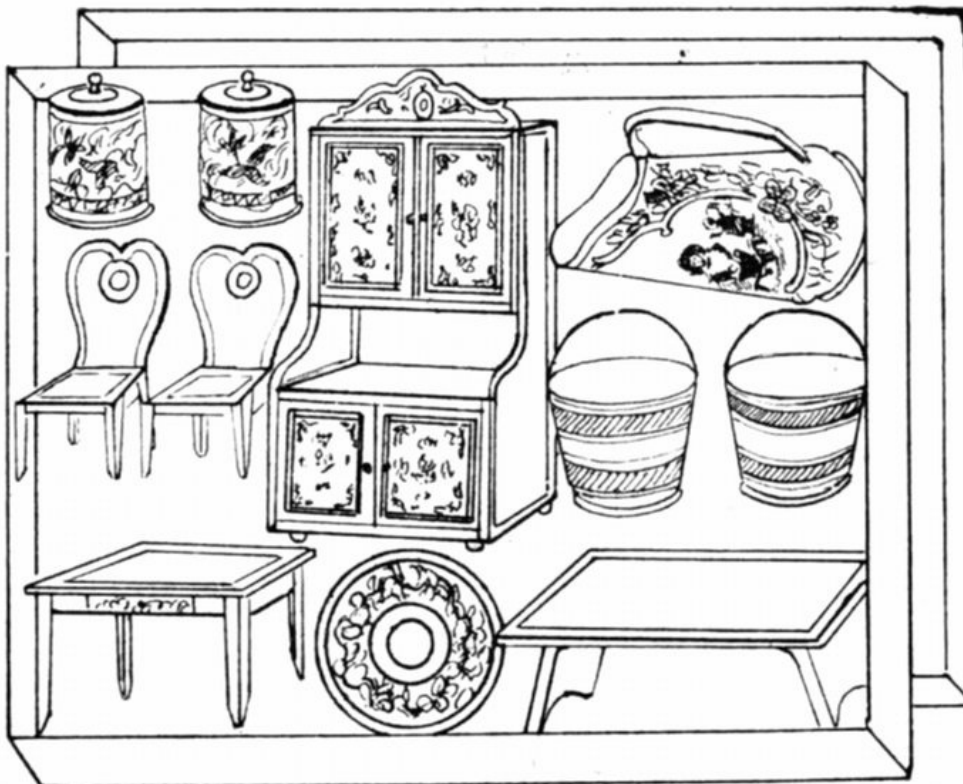

No. 355/23.

355/23.

As cut. Consists of cupboard, 6½ inches high, bench, table, 2 chairs, 2 pails, large jug and 2 covered cans. Each set in a box. Size, 12 × 9½ inches

\$8 00

14/562.

Furniture set. Consisting of roll-top desk, 4 inches long; mirror front cupboard 6 inches high; sofa, table, 2 reception chairs, and 2 Rocking chairs. Each set in a box. Size 12½ × 8¾ inches

8 00

14/563.

Furniture set. Consisting of roll-top desk, 5 inches long, cupboard 6½ inches high; fancy table, office chair, 2 reception chairs, 2 rocking chairs and sofa; all embossed shapes and with cloth fringe decoration. Each set in box. Size, 17 × 11 inches

18 00

MECHANICAL LOCOMOTIVES.

With Reliable Clockwork.

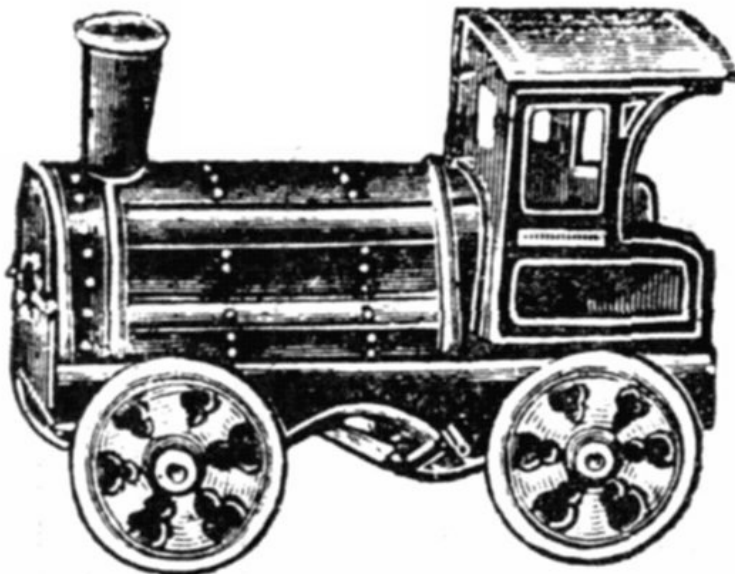

No. 212 and 213A.

212.

213A.

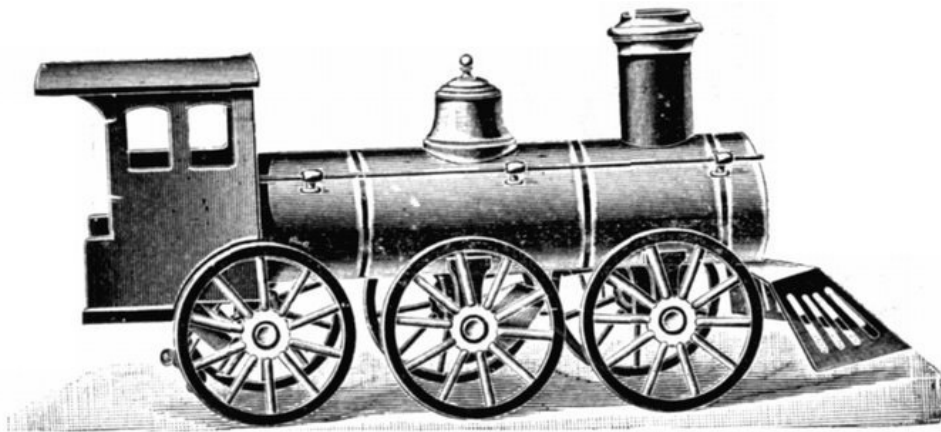

No. 237/50.

Dozen.

Tin body, in bright colors. Has reverse motion so that when the clockwork is wound up the engine runs backwards and forwards, reversing automatically. Length, 6¾ inches; height, 5 inches. Each in box.

\$4 00

Same size and style as No. 212, but instead of having reverse motion it is made to run in any size circle desired. Each in box.

4 00

237/50.

14/747.

14/728.

14/418.

Dozen.

as cut. Strong tin body in bright colors. When wound up will run several yards, ringing a gong bell as it runs.

\$8 00

Length, 9 inches; height, 4 inches. Each in box

as above. Length, 12 inches; height, 5 inches

12 00

Similar to above, but finer quality and finish throughout, and has solid metal wheels.

24 00

Length, 23 inches; height, 5½ inches

A large and handsome locomotive, very complete in details and brass trimmed. Length, 16 inches; height, 6 inches

36 00

MECHANICAL TRAINS ON TRACKS.

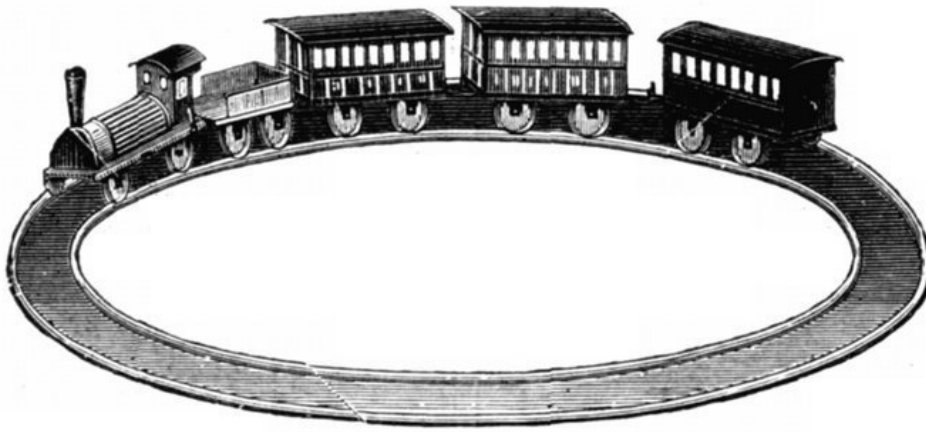

Tin Bodies in Bright Colors; Solid Metal Wheels.

14/555.

14/556.

14/557.

14/559.

14/560.

14/601.

14/602.

Dozen.

Consists of engine with tender attached, 2 cars. Length, 10 inches. Jointed track, oval shape, 20 inches long. All packs neatly in a box \$8 00

Consists of large size engine, tender and one car. Length, 12 inches. Jointed round track, 20 inches in diameter. Each complete in a box 13 00

Consists of large size engine, tender, two cars. Length, 17 inches. Jointed oval track, 33 inches long. Also finely lithographed tin tunnel through which the train passes. Each complete in a box 20 40

Same as 14/557 but has a fine lithographed tin station house, which adds greatly to the attractiveness of the article 27 00

Similar to above, but larger cars and has figure "8" track, 4 ft. long. Each complete in box 42 00

Consists of engine, tender, two cars, signal house and station. Length of train, 18 inches. Has combination set of tracks that can be formed into circle, oval or figure "8," about 6 feet long. Each complete in box 60 00

Similar to above, but 22 inch train, and in place of station has large tunnel. Each complete in box 78 00

MECHANICAL TOYS.



Flying Bird.

Dozen.

We offer this well known toy as a leader in this department. Each in box.

\$2 40

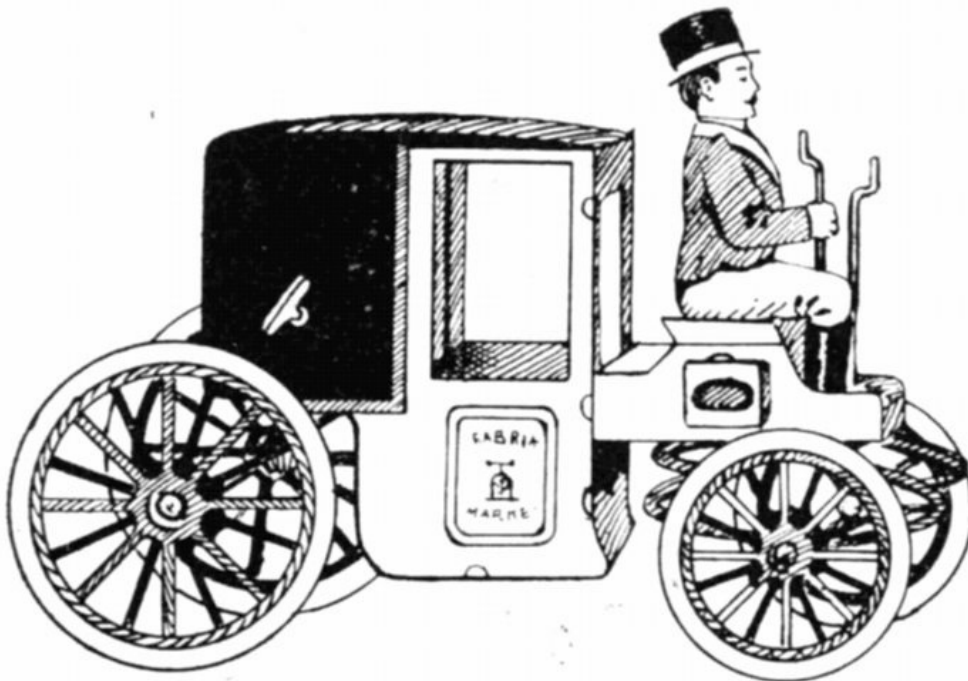

Mechanical Automobile.

Automobile

Dozen.

as cut. Tin body in bright colors. An exact imitation in miniature of the latest motor carriage. Has reliable clockwork and is adjustable to run in any size circle desired. Size, 5 x 3½ inches. Each in a box

\$3 70

345. Motor Tricycle.

Similar in size to above but is a three-wheeled vehicle. In main seat is figure waving high hat, and in back seat is colored servant figure with revolving umbrella. Size, 5 x 4½ inches. Each in box 3 70

221. Trolley Car,

4 00

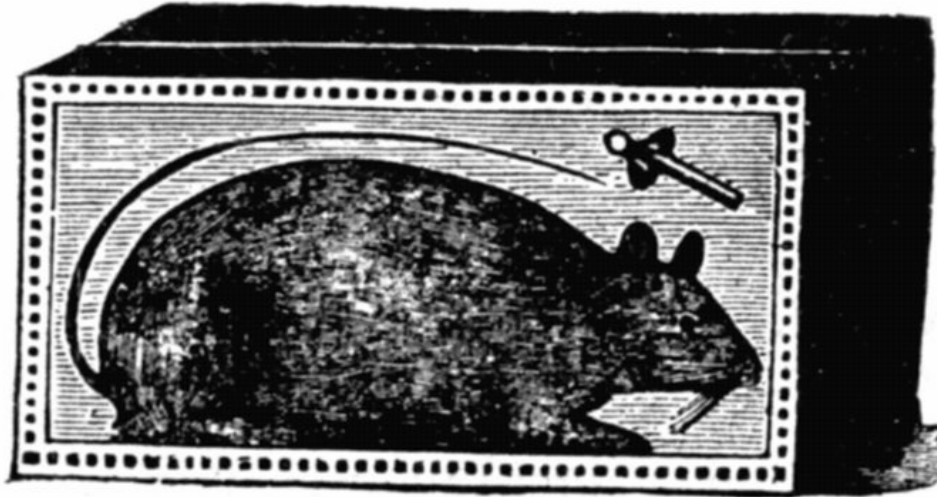

14/516. Clockwork Mouse.

Dozen.

A fur covered life size mouse, so realistic in its movements that you think it alive. Each in box \$4 00

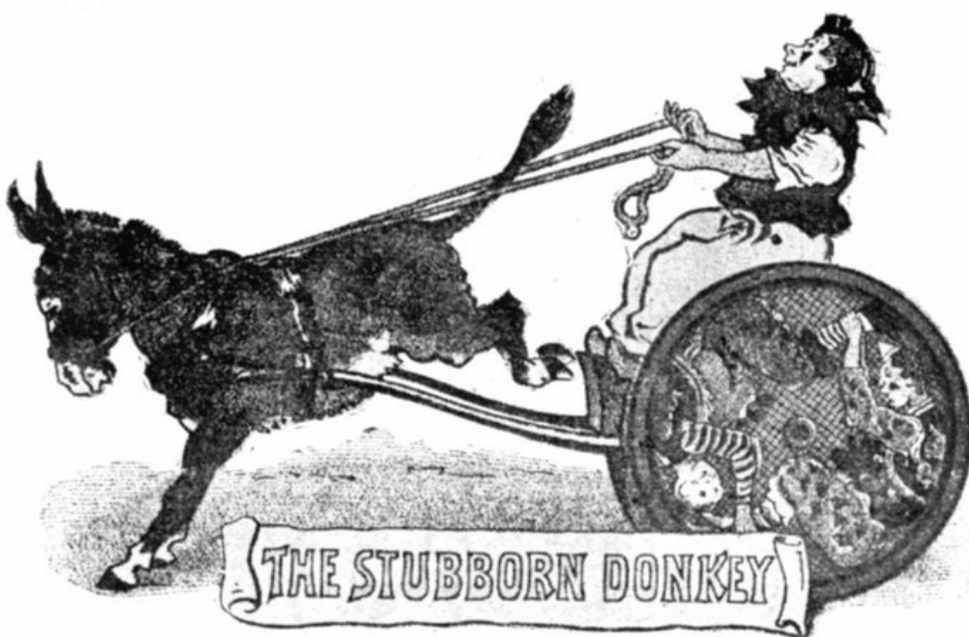

THE STUBBORN DONKEY

Stubborn Donkey.

Dozen.

The animal runs forward, balks, kicks and backs up, whilst the clown bobs up and down trying to control the donkey by jerking the lines. Runs by reliable clockwork. \$7 50

14/585. Rough Rider.

The subject is a Rough Rider on horse with wheels. Has clockwork which when wound up sets the piece in motion, and the rider 6 00

1. Seal.



175. Khaki Soldier,

14/740. Boat Wheel,

waves his rifle very realistically as he rides madly round in a circle. Height, 7 inches; packed each in a box

A perfect imitation of this animal. When wound it runs around in different directions moving its limbs very naturally. Each in a box.

7 50

Dozen.

8 inches high. Metal body with Khaki cloth suit; clockwork. Has bayonet fighting motion. Each in a box 9 inches high; with clockwork. Painted in colors. Has two boats with occupants. As the boats revolve a chime bell keeps ringing. Each in box

\$8 00

8 40

MARCHING SENTRY.

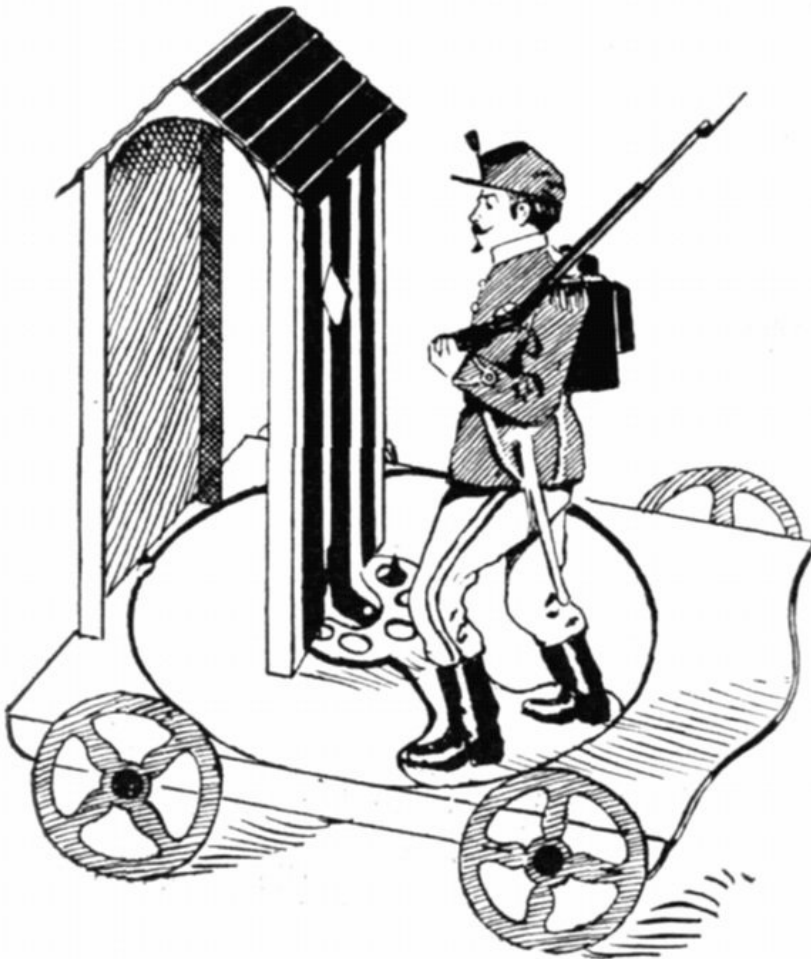

No. 61/723.

61/723.

Dozen.

As cut. Lacquered tin in colors. As the toy is drawn along the sentry keeps going his round step by step. Size, $4\frac{1}{2} \times 4\frac{1}{4}$ inches. Extra good value; 1 dozen in package

\$ 1 60

Friction Gun Boats.

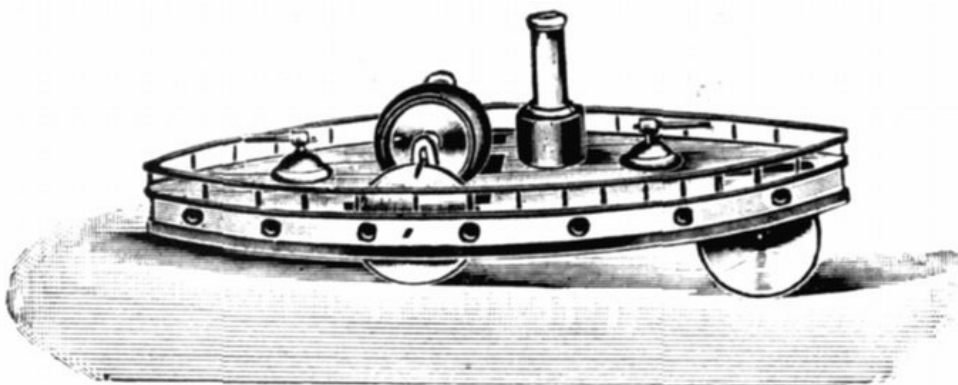

No. 367/341.

61/716.

Dozen.

Similar to cut. Lacquered tin. Length, $6\frac{1}{2}$ inches. Has forward and wave motion; 1 dozen in package

\$ 1 60

367/341.

As cut. Strong tin body painted in colors. Length, $8\frac{1}{2}$ inches. Has very realistic forward and wave motion; $\frac{1}{2}$ dozen in

4 00

package

Tin Street Car.

14/120.

Painted car with horse.
Length, 6½ inches; 1 \$ 1 40
dozen in package

TIN ANIMALS.

Dozen.

61/753.

Lacquered tin animals,
assorted; on platform
with wheels. Length, 4 \$ 0 70
inches; 3 dozen in
package

2127.

Painted tin **Horse** on
platform with wheels. 1 60
Length, 6 inches; 1
dozen in package

Toy Steel Spade.

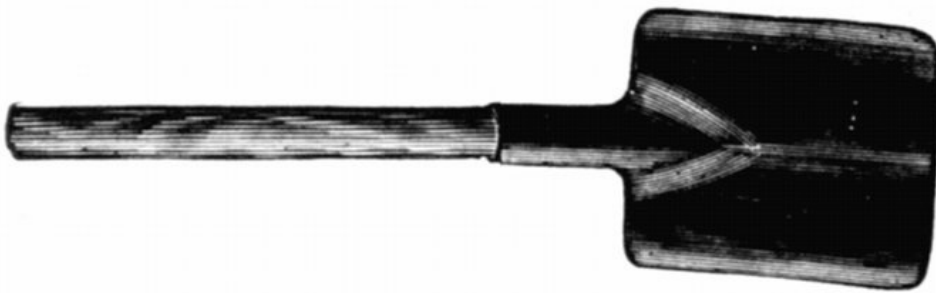

No. 6.

Dozen.

6.

Black japanned steel
Spade, 4 inches wide.
Natural wood handle. \$ 0 80
Entire length, 15
inches

Toy Dust Pans.



No. 355/22.

355/22.

73.

Dozen.

As cut. Lithographed tin. Size, 8 × 6½ inches; 1 dozen in package \$ 0 90

Embossed and colored all over, flower pattern. Size, 8½ × 7½; ½ dozen in package 90

AIR RIFLES.



Globe Single Shot.

4. "Globe" Single Shot.

Dozen.

Has a new locking device which will not permit the gun to rattle or break down when you shake it. The stock is made of selected hardwood and finished in natural color or walnut. All metal parts are finely finished and nickel plated. Each rifle is tested and accurately sighted before leaving the \$16 80

factory. Entire length,
30 inches



Globe Repeater.

Dozen.

Similar to No. 4, but is a "Repeater." The magazine holds 300 BB shot. It has a sight feed, and repeats from the muzzle, which makes it shoot strong. The Repeater can be used as a single shot when desired

\$26 40

40. "Globe" Repeater.

VACUUM AIR PISTOL.



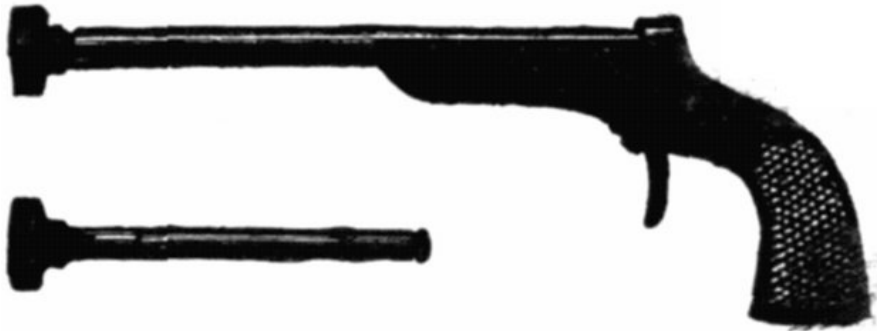

The Great Family Amusement Game.

Consists of 8-inch Pistol and wooden arrow with rubber tip. The arrow adheres to the target by force of vacuum. The game is not only intensely interesting, but instructive; it trains the eye and cultivates judgment.

Complete with pistol, arrow and target put up in fancy lithographed box
Arrows extra for above

Dozen.

\$ 9 00
3 00

Cap Pistols.

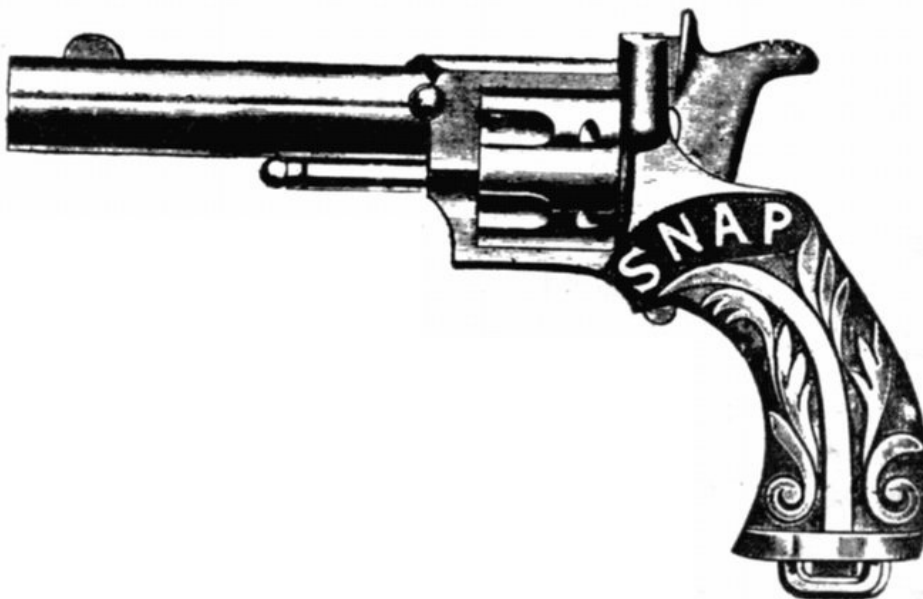

Snap.

Dixie.

Colt.

503A.

405.

Dozen.

White nickel finish.
Length, 4 inches \$ 0 70

White nickel finish.
Length, 5½ inches 90

White nickel finish.
Similar pattern to
Snap. Length, 5½
inches 1 20

"Army," white nickel
finish. Length, 7 inches 2 00

"Captain," white nickel
finish. Hammerless. 3 00
Length, 7 inches

FUR GOAT.

Moving Head, and Voice.

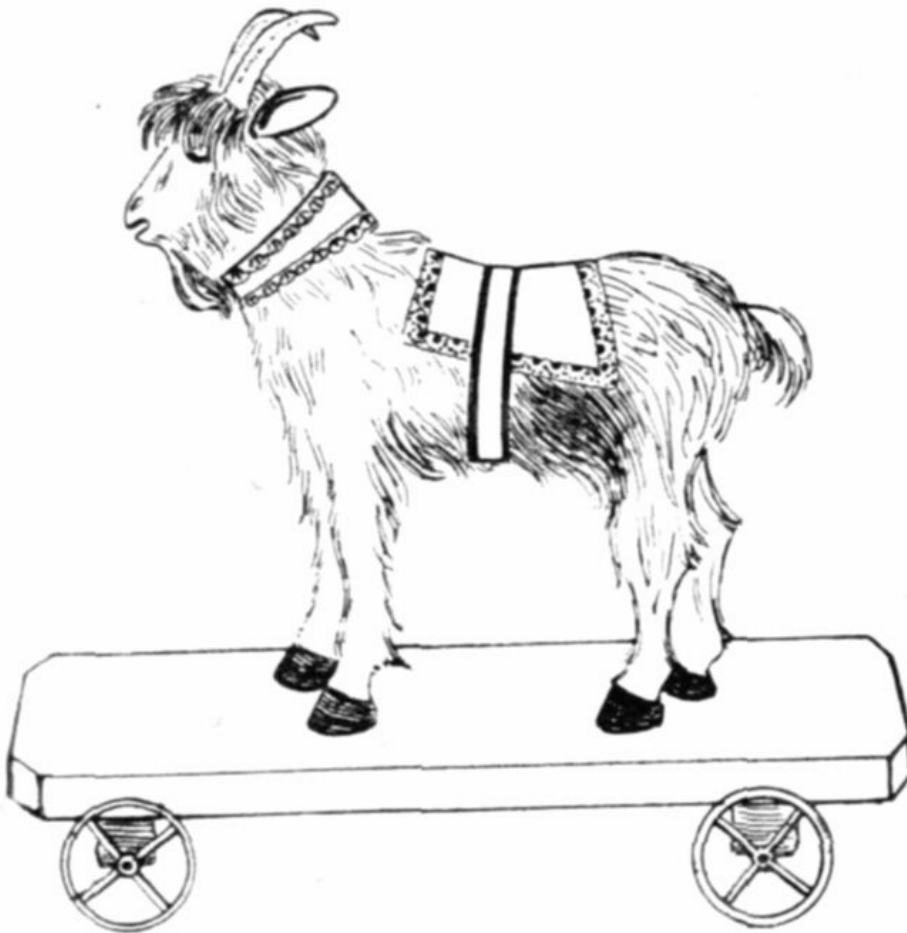

No. 408/15.

408/15.

408/16.

Dozen.

As cut. Real fur; mounted on platform with wheels; moving head, with voice.

\$26 40

Length, 12½ inches; height, 13 inches

As above, but larger.

Length, 14½ inches; height, 15 inches

36 00

Black Fur Dogs.



No. 178/0.

178/0.

178/1.

178/2.

178/3.

178/4.

Dozen.

On castors as cut. Height, 6 inches. ½ dozen in package

\$3 50

As above. Height, 7½ inches. ½ dozen in package

4 80

As above. Height, 8 inches. ½ dozen in package

6 50

Extra strong, with iron feet and castors.

9 60

Height, 9½ inches
As 178/3, but 12 inches high

16 80

LEATHER COWS.

Moving Head, and Voice.

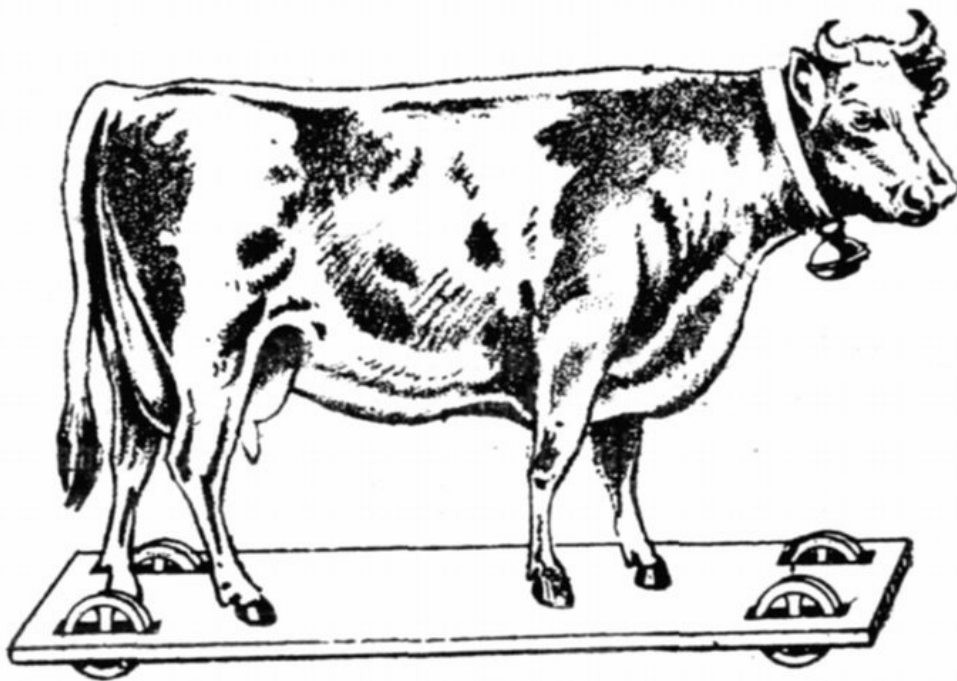

No. 410/1.

Dozen.

271/44.

Leather covered in natural color, on platform with wheels. Has moving head and voice. Height, 6 inches; length, 8½ inches. ½ dozen in package \$11 00

401/1.

As above, but larger and has milking teats and fluid receptacle. Height, 7½ inches; length, 11½ inches. Each in package 16 00

410/2.

As above. Height, 8½ inches; length, 11½ inches 26 40

410/3.

As above. Height, 10 inches; length, 13½ inches 36 00

Woolly Sheep.

Moving Head and Voice.



Wool covered sheep on wood platform with wheels. All have moving head and bleating

voice.

86/70.

156/26.

96/79.

96/72.

Dozen.

Height, 6 inches. ½ dozen in package \$4 00

" 8 " ⅓ " " 8 40

" 9 " ⅙ " " 12 00

" 10½ " ⅙ " " 20 40

CROWING ROOSTERS.



No. 380/5.

Dozen.

Cloth and feather

154/49.

rooster, 3½ inches high, mounted on crowing bellows trumpet. 1 dozen in package \$2 40

380/4.

As cut. Feather covered rooster in natural colors. Has attached a small rubber tube, which when blown into causes the rooster to stretch up his head and crow in the most natural manner. Height, 4½ inches. ½ dozen in package 4 00

380/5.

Same as 380/4, but is larger, being 6 inches high, and has flapping wings 8 00

Dancing Bear.



No. 393/62.

393/62.

Dozen.

As cut. Fur bear, 7 inches high that dances as the rubber air bulb is squeezed and relaxed. ½ dozen in package \$4 00

Jumping Donkey.

393/61.

On the same principle as the Dancing Bear, but is a linen paste donkey that jumps and brays as the bulb is manipulated. ½ doz. in pkg. 4 00

PERFORMING FIGURES.

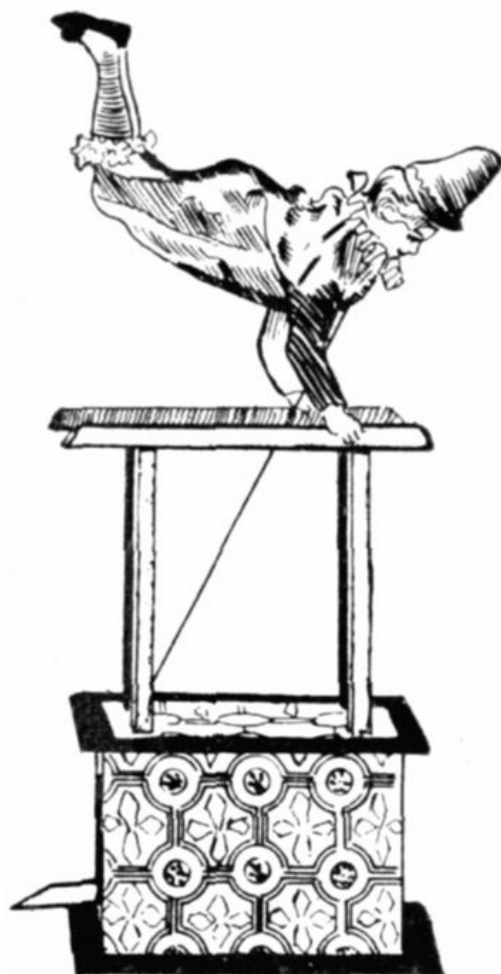

No. 410/4.

410/4.

Dozen.

Assorted. Six kinds, comic performing figures on platforms, and bellows. ½ dozen (6 kinds) in package \$4 00

Wool Hoop Toy.



No. 318/7.

318/7.

1762.

Dozen.

Clown 8 inches tall in wool hoop with elastic cord attached. Has tassels and bells

\$4 00

Same as above, but hoop made of twisted wire, extra good value

2 50

Wool Animals.



No. 93/66.

93/45.

Dozen.

Small size assorted animals covered with wool felt. 1 dozen in package

\$1 60

As cut. Cats, dogs and Rabbits assorted. All are with voice, and

93/66.	have best quality wool felt covering. Average height 5 in. ½ doz. in pkg.	4 00
93/67.	As 93/66 but are 6½ inches high. ½ doz. in pkg.	5 50
318/8.	Elephant, 9½ inches high. An extra large and fine quality. Each in package	20 40
318/9.	Dog. Same quality as 318/8. Height, 10½ inches. Each in package	20 40

SURPRISE BOXES.



No. 156/15.

Assorted comic figures in paper covered wood boxes. All have voice.

156/14.

Dozen.

Height open, 5½ inches. 1 dozen in package

\$0 70

156/15.
 156/120.
 156/16.
 156/18.

" " 7 " 1 " " 1 50
 " " 8 " 1/2 " " 2 40
 " " 8 1/2 " 1/2 " 2 80
 " " 8 " 1/2 " " 4 00

Double Face.

Surprise Figure.



380/1.

Dozen.

Similar to cut, but outer face represents Paul Kruger. When the figure is pressed downwards a comical face emerges from under his high hat. Height, 12 inches. 1/2 doz. in package

\$4 00

Monkey Toys.

380/1.

Dozen.

Small-sized dressed monkey on elastic cord. 1 dozen in package

\$0 80

380/2.

Dressed monkey with baby on elastic. A slight movement of the hand when holding the elastic makes the monkey jump up and down, all the time dancing the baby

1 60

CLAPPING TOYS.



411/1.

411/2.

411/3.

324/2.

324/7.

324/3.

Dozen.

Bisque head; dressed in bright colors. Length, 10 inches, 1 dozen in package	\$0 80
Bisque head, and with squeaker; dressed in bright colors. Length, 12 inches. 1 dozen in package	1 70
As above, but larger	3 00
Assorted, fancy dressed figures with bisque head and sleeping eyes. Length, 12 inches. ½ dozen in package	4 00
As 324/2, but 13 inch size, ½ dozen in pkg.	5 50
As 324/2, but 15 inch size; extra fine. ½ dozen in package	8 00

STICK TOYS.



156/22.

Assorted, comic figures with squeaker and whistle handle. Entire length, 12 inches. 1 dozen in package

1 70

156/23.

Similar to above, but 16 inch size. ½ dozen in package

4 00

324/1.

Bisque head with hair; assorted fancy dresses with bells. Length, 12 inches. ½ dozen in package

4 00

324/4.

As 324/1, but 15 inch size

9 00

BELLOW TOYS.



No. 6173.

154/28.

6173.

6174.

156/63.

Dozen.

Woolly lamb, 2 dozen in pkg.	\$0 70
Assorted papier-mache animals and fowl. 1 dozen in package	60
Same as 6173, but larger	1 50
Large animals, 6 kinds, ½ dozen packages	3 00

NOAH'S ARKS.

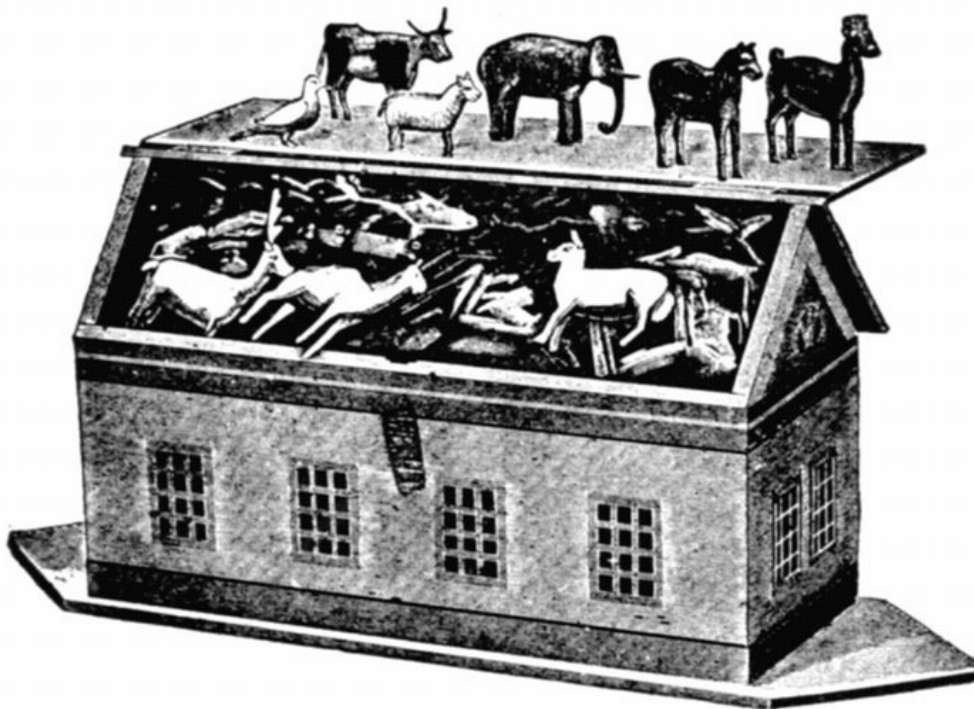

Painted in bright water colors.

	Dozen.	
0/10.—	Animals, size, 7 inches long by 3¼ inches high; 1 dozen in package	\$ 0 70
2/12.—	Animals, size, 8 × 3½ inches; 1 dozen in package	80
3/20.—	Animals, size, 10½ × 4½ inches; 1 dozen in package	1 60
4/25.—	Animals, size, 11½ × 5¼ inches; ½ dozen in package	2 00
5/30.—	Animals, size, 12½ × 5½ inches; ½ dozen in package	3 00
6/35.—	Animals, size, 14 × 6 inches; ⅓ dozen in package	4 00
8/50.—	Animals, size, 17½ × 7½ inches; each in package	7 50
9/65.—	Animals, size, 18½ × 8 inches; each in package	10 80

Following are painted with Oil Paint and have fancy lithograph decoration. Each Ark is well filled with large and well shaped animals.

	Dozen.	
1234/4.	Size, 11 × 4¾ inches; ½ dozen in a package	\$ 4 00
1234/5.	Size, 13 × 5½ inches; ⅓, dozen in a package	8 00
1234/6.	Size, 14 × 6 inches; ⅓ dozen in a package	12 00
1234/7.	Size, 15½ × 6½ inches; each in a package	16 00
1234/8.	Size, 18 × 7 inches; each in a package	21 60

Boat Arks.

Natural wood Arks, glass windows. Well filled with unpainted animals.

	Dozen.	
1205/2.	Length, 10 inches	\$ 4 00
1205/4.	" 12 "	8 00

DRIVING REINS.



1.

1X.

251.

71.

Dozen.

A double 4 feet $\frac{7}{8}$ inch web rein, with leather breast-strap and three bells; 1 dozen in package \$ 1 60

As above, but is with closely woven rein 1 inch wide; 1 dozen in package 2 00

Fancy color striped, finely woven, $1\frac{1}{4}$ inch rein with fine breast-strap and three bells; 1 dozen in package 3 60

An extra fine and strong rein, having cords inside and closely woven covering. Has fancy double breast-straps with 6 large bells 5 50

Magnets.

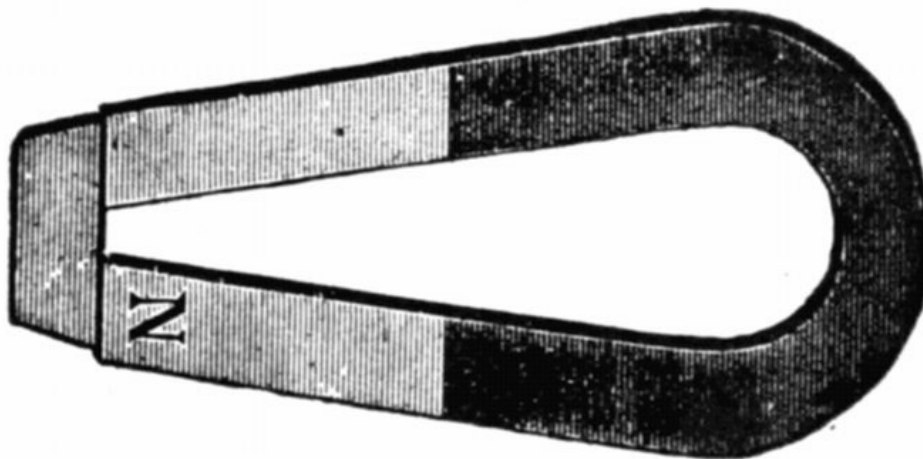

- 4588/7.
- 4588/8.
- 4588/10.
- 4588/11.
- 904/5.

Dozen.

2 $\frac{3}{4}$ inches long	\$ 0 60
3 $\frac{1}{4}$ " "	80
4 " "	1 50
4 $\frac{1}{2}$ " "	2 00
5-1/2 " Boker's	2 40

Call Bells.



No. 14/461.

14/461.
3829.
14/462.

Dozen.

Table bell, nickel plated	\$ 2 20
" " "	3 00
Hand " "	3 20

CHINA LIMB DOLLS.

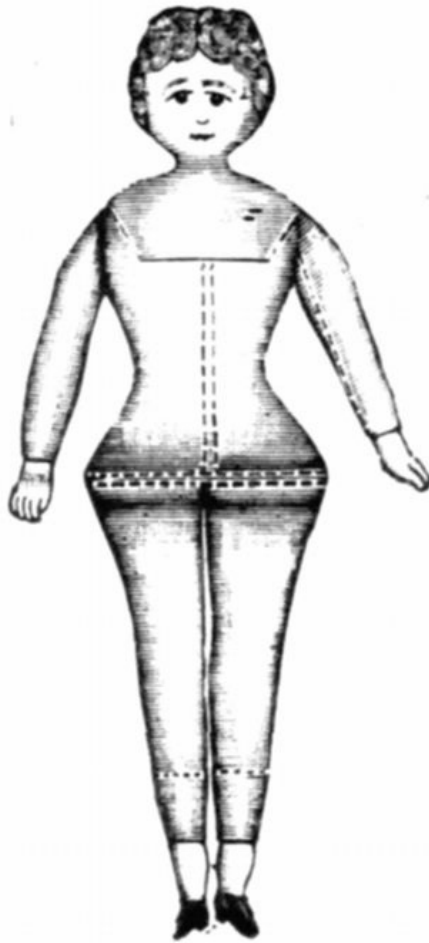

No. 36/1.

Standard quality, strong cloth body, glazed china head, arms and feet.

33/1.
33/2.
33/3.
33/4.
36/1.

33/5.
33/6.
33/7.
33/7½.

Gross.

4 in. long, 1 gross in pkg.	\$ 3 60
5½ in. long, ¼ gross in package	5 50
7¼ in. long, ⅓ gross in package	7 20
8½ in. long, ⅓ gross in package	8 40
8 in. long, ⅓ gross in package, extra quality.	9 60

Dozen.

10½ in. long, 1 doz in pk.	1 30
12½ " " 1 " "	1 60
13 " " ½ " "	2 20
14 " " ½ " "	2 80

33/8.
33/9.

15½ " " ½ " " 3 60
18 " " ½ " " 4 00

A B C Dolls.



No. 44/3.

Standard quality, glazed china head, arms and feet, strong cloth body printed with letters of the alphabet, pictures of animals with names, etc.

44/2.

44/3.

44/4.

44/5.

Dozen.

9 inches long, 1 dozen in package	\$ 0 90
11 inches long, 1 doz. in package	1 50
12 inches long, ½ doz. in package	2 00
13½ inches long, ½ dozen in package	2 80

Solid China Babies.

WHITE GLAZE.



No. A/3.

A²/₃.
 A/0¹/₂.
 1K.
 A/2¹/₂.
 A/3.
 A/4.

Gross.

2 inch, ½ gross in box.	\$ 2 00
2¾ inch, ⅓ gross in box.	3 60
3¼ " 1-12 " "	4 80
3¾ " 1-12 " "	7 20
4 " 1-12 " "	8 40
4¾ " 1-12 " "	10 80

Negroes.

BLACK GLAZE.

N⁵/₀.
 N²/₀.
 NO¹/₂.
 N2.
 2K.N.
 3K.N.

Gross.

1½ inch, ½ gross in box	\$ 1 80
2¼ " 1-12 " "	3 60
2¾ " 1-12 " "	4 80
3 " 1-12 " "	6 00
3½ " 1-12 " "	7 20
4 " 1-12 " "	9 00

WASHABLE DOLLS.



No. 302/45.



No. 96/51 & 96/53.

Paste head and limbs, mohair curls, glass eyes, fancy shirt. Extra large and showy.

156/15.

156/16.

303/52.

303/60.

302/45.

304/52ME.

As above, but with jointed Perambulator seat, cloth body.

96/51.

96/53ME.

Dozen.

16½ inch, 1 dozen in box	\$ 2 00
17½ " 1 " "	2 50
21½ " 1 " "	3 60
24 " ½ " "	4 00
18 " as cut, 1 dozen in box	4 00
20 " sleeping eyes, 1 dozen in box.	4 00
12 inch, as cut, 1 dozen in box	\$ 4 00
As above, sleeping eyes	4 50

WITH PAPA AND MAMMA VOICE.

234/47.

14½ inch, 1 dozen in box	\$ 4 00
--------------------------	---------

Bisque Babies.

Flesh colored bisque china, with hair, loose arms, painted shoes and stockings.

Dozen.

317/8.

3¾ in., long plaited hair, 2 doz in box	\$ 0 80
---	---------

317/9.

4 inch, as above, 1 dozen in box	1 30
----------------------------------	------

317/10.

5 inch, as above, 1 dozen in box	1 80
----------------------------------	------



No. 194^{3/0}.

FINER BISQUE.

- 194^{6/0}.
- 194^{5/0}.
- 194^{4/0}.
- 194^{3/0}.
- 194^{2/0}.

3 inch, long hair, 1 dozen in box	\$ 1 50
3½ inch, as above, ½ dozen in box	2 00
4½ inch, as cut, ½ dozen in box	2 50
5 inch, ½ dozen in box	3 00
6 inch, ½ dozen in box	4 00

KID BODY DOLLS.

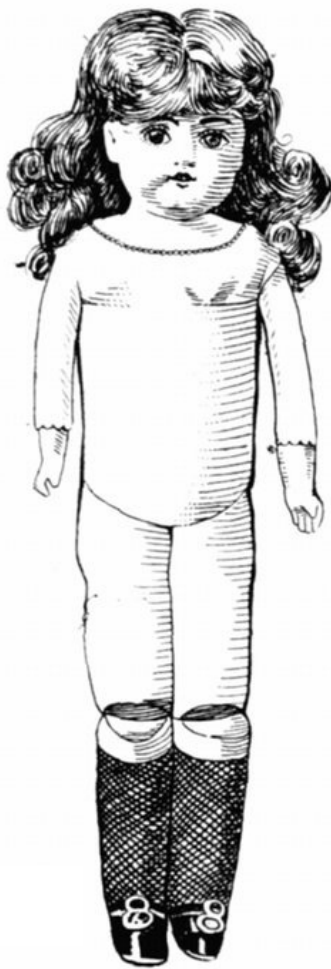

No. 370/11.



No. 370/23.

Full kid bodies, bisque heads with hair, cut joints, shoes and stockings.

- 22.
- 370/7.
- 23
- 370/11.
- 25.

Dozen.

12-inch, 1 dozen in box	\$3 80
13-inch, 1 dozen in box	4 00
11½-inch, rivet joint elbow, 1 dozen in box	4 00
15½ inch, as cut, ½ dozen in box	6 50
15-inch, rivet joint elbow and sewn wig, ½ dozen in box	8 00

Same as above, with sleeping eyes.

All have cut joints, shoes and stockings.

- 370/9.
- 370/12.
- 370/15.

Dozen.

12 inches long, 1 dozen in box	\$4 00
15 " ½ " "	7 20
17 " ½ " "	8 40

With Jointed Legs, as cut 370/23.

- 370/23.
- 370/24.
- 370/25.

Dozen.

17-inch, ½ dozen in box	\$12 50
19½-inch, each in box	16 80
25½ " " "	26 40

FINE KID BODY DOLLS.

Best quality half cork stuffed kid body, beautifully modelled heads with long curly hair. All have moving eyes, except Nos. 544 and 545. Cut joints.

- 544.

Dozen.

11 inches long, 1 dozen in a package	\$4 50
--------------------------------------	--------

545.	12 " 1 " "	6 50
593.	16 " each in a box	16 00
594.	17 " " "	21 00
595.	21 " " "	27 00
595½.	21¾ " " "	32 00
596.	22¼ " " "	36 00

As above, but have Hair done up in top-knot.

94/18.	17½-inch, each in box	\$24 00
94/20.	22 " " "	42 00

Jointed Dolls.

Dozen.

411/5.	6¼-inch. Bisque head, curly hair; jointed arms and legs; naked limbs; fancy chemise. Each in box	\$3 00
411/6.	8¼-inch. Similar to above, but has limbs and wrist; sleeping eyes. Each in box	4 50
double jointed	13½-inch. Double jointed limbs; sleeping eyes. Each in box	8 00

"JUMEAU" JOINTED DOLLS.

The finest of French Jointed Dolls. All have double jointed limbs, jointed wrist. Beautifully modelled features, sleeping eyes with eye-lashes, fine curly hair; shoes and stockings. Very fancy chemise, trade marked "Jumeau, Paris."

Dozen.

5.	16-inch, each in box	\$42 00
6.	17½-inch, " "	48 00
7.	19 " " "	60 00

DRESSED DOLLS.

Dressed China Babies

Gross.

90/6.	One cent leader. China baby 2¼ inches long. Jointed arms. Assorted colored dresses; 1/12 gross in display box	\$2 00
90/11.	Dressed china baby 3¾ inch size; 1/12 gross assorted in display box	4 50
90/7.	As 90/11 but more fancy dresses	6 50
90/8.	As 90/11 but 4 inch size; 1/12 gross assorted in display box	7 20
90/4.	As above, but each in a box and with baby in arms	8 40

Bisque Head, Glass Eyes, Jointed Paste Limbs, Painted Shoes and Stockings.



No. 292/13.

90/2.	Dozen. 7 inch, assorted boys and girls; 1/6 dozen (boy and girl) in box	\$1 30
292/13.	As cut, 5 1/2 inch; assorted colored dresses; 1/2 dozen assorted in box	1 30
292/4.	As 292/3 but 6 1/2 inch size; 1/2 dozen assorted in box	1 60
292/29.	7 1/2 inch. An extra large and showy doll for the money; assorted colored plain muslin dresses; 1/2 doz. in box	1 60
292/30.	7 1/4 in. Eaton jacket costume with gilt buttons; 1/2 dozen assorted in box	2 40

Following are with Shoes and Stockings.

90/13.	Dozen. 7 inch, assorted dresses; each in box	2 50
90/15.	10 inch, assorted nations; each in a box	4 00
292/16.	10 1/2 inch, Little Red Riding Hood; each in a box	4 00



No. 380/9.

Big 25 cent Leader.

380/9.

291/43.

12 inch, as cut. Four kinds, assorted costumes and colors. Good features and well dressed. Exceptional value; each in a box \$4 50
14 inch, similar to above, but has cloth body; each in a box 6 50



No. 398/11.



No. 325/3.

The following Lines are all with Fine Bisque Head, Mohair Curls, Shoes and Stockings, and are Well Dressed throughout.

	Dozen.	
398/1.	14 inch, assorted; each in box	\$8 00
292/23.	18½ inch, assorted; each in box	12 00
291/47.	14 inch, sleeping eyes, extra fine, assorted; each in box	13 50
291/31.	15 inch, steady eyes, assorted; each in box	16 00
325/3.	15½ inch, sleeping eyes, extra fine, assorted; each in box	18 00

Fine Dressed Dolls.

The following are Extra Quality, Handsome Assorted Dresses and Fine Curls. All have Sleeping Eyes.

	Dozen.	
325/4.	16½ inch; each in box	\$25 20
325/5.	19 inch, jointed hands; each in box	33 60
325/6.	21 " " " " "	60 00
325/7.	21 " As above but finer dresses	66 00

NOTE.—All lengths of dolls given are exclusive of headdress.

SOLDIER DOLLS.



No. 90/18.

90/14. Assortment.

90/18. Khaki Uniform.

90/19.

B/1.

Dozen.

Five kinds of uniforms. Bisque heads, stuffed bodies. Length, 10 inches; ½ dozen in box \$4 00

As cut. Bisque head, jointed body. Length 10 inches; ½ dozen in box 4 00

As above, but 11½ inch size. Each in a box 6 50

Similar to above but finer quality, having wool felt uniform and hat, full jointed body, 8 00

B/2.

B/6.

complete equipment.
 Length, 12 inches.
 Each in a box
 As B/1 but 13 inch size. 12 00
 Each in a box
 As B/1 but 5½ inch
 size. Each in box 16 00

Marching Khaki Soldier.

Dozen.

A finely dressed and fully equipped Khaki Soldier made on the well known Walking Doll principle 24 00

German Nurse Doll.



No. 291/48.

In Nurse's costume. Each with dressed baby in arms.

291/24.

291/48.

91/49.

391/50.

Dozen.

10½ inch. Bisque head,
 with hair, and painted \$4 00
 shoes; ½ dozen in box
 14 inch. As cut, is well
 dressed throughout, 12 00
 and has shoes and
 stockings. Each in box
 15½ inch as above. 16 00
 Each in a box
 17 inch as above. Each 25 00
 in a box

DRESSED RAG DOLLS.

With Painted Cloth Face.

Dozen.

411/15.

10 inch. Painted cloth
 face, with hair, rag \$3 60
 baby, assorted dresses;
 1 dozen in box

229/2.	15 inch, similar to above; 1 dozen assorted in box	4 00
291/56.	12 inch. Finer quality than above and has shoes and stockings. Each in a box	5 00
291/57.	14 inch size, as above. Each in box	8 00

With Paste Gauze Face.

291/52.	14½ inch. Well featured paste gauze face, rag body and limbs, assorted dresses with shoes; ⅓ dozen in box	6 50
32/93.	14 inch similar to above but has composition arms; ⅓ dozen assorted in box	8 40
329/4.	16 inch, as above. Each in box	12 00
329/5.	18 ½ inch " " "	16 00

English Rag Doll.

43/10.	Dozen. 12½ inch "Little Red Riding Hood"; 1 dozen in box	2 40
--------	--	------

Rag Baby.

329/6.	Dozen. Paste gauze face, assorted long dresses. Entire length 19 inches; ½ dozen in box	4 00
--------	---	------

Wool Dolls.



Cloth stuffed bodies, knitted *dresses* in assorted colors.

93/1.

93/25.

The following are with voice:

93/24.

93/64.

93/26.

93/27.

Dozen.

7 inches long; 1 dozen in box	\$1 60
12 inches long; ½ dozen in box	4 00
10 inches long; ½ dozen in box	4 00
11½ inches long; ½ dozen in box	4 00
13 inches long; ⅓ dozen in box	8 00
14 inches long; ½ dozen in box	12 00

DOLL SPECIALS.

Bisque Head, Cloth Body.

234/59.

291/45.

Dozen.

11½ inch. Bisque head, paste limbs, with hair, cloth body, fancy chemise. ½ dozen in box	\$1 80
10 inch. Bisque head with hair, cloth body and feet, shoes, fancy chemise	2 20

Imitation Kid Body.

291/46.

14 inch. Bisque head, hair stuffed, imitation kid body, shoes and stockings. 1 dozen in box	\$4 00
---	--------

Baby Dolls.

Dozen.

292/7.	Bisque head, long dress baby. Entire length, 7 inches. 1 dozen assorted in box	\$1 60
291/15.	Bisque head, sleeping eye baby. Fine cloth body with perambulator seat joint. Fancy night dress and bonnet. Length of doll 11 inches. ½ dozen in box	4 00
291/37.	Bisque head, sleeping eyes, assorted fancy pattern, long baby dresses. Entire length 4½ inches. ½ doz. in box	4 60
291/38.	As above, but 17½ inch size. Each in box	8 00
291/39.	As above, but 19 inch size. Each in box	9 60

Klondike Dolls.

382/1.	Bisque head, with hair. Dressed in wool fur from head to foot, and equipped as a Klondike miner. Length, 9½ inches. ½ dozen in package	\$4 00
382/2.	As above, but 12 inch size. ½ dozen in box	8 00

Doll Shoes.

Dozen Pair.



52/7.	Fancy shoes with string ties assorted sizes 0 to 3	\$0 60
52/2.	Assorted. Sizes, 0 to	5 1 30
393/47.	" " 2 to	7 1 60

Doll Stockings.

52/61.	Assorted colors, sizes 2 to 7 assorted	\$0 70
--------	--	--------

Have also larger sizes at \$1.20, \$1.30, \$1.50, \$1.60, \$1.70 and \$1.80, dozen pairs.

RUBBER DOLLS.

Naked, as Cut.

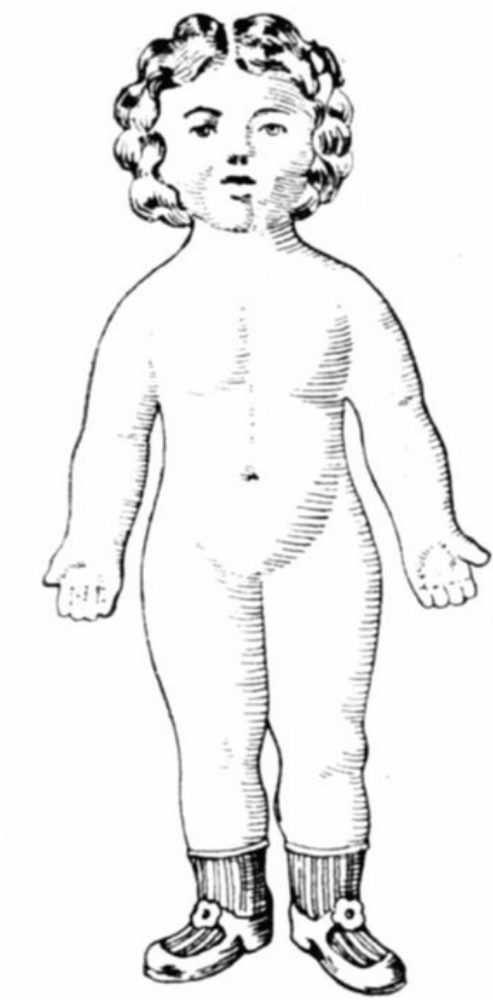

No. 61/662.

61/660.

61/661.

61/662.

61/663.

61/665.

Dozen.

Length, 4 inches. 1 dozen in package	\$1 60
Length, 4 ³ / ₄ in. 1 dozen in package	2 40
Length, 5 ³ / ₄ in. 1 dozen in package	3 20
Length, 6 ¹ / ₂ in. ½ doz. in package	3 80
Length, 9 inches	7 60

With Knitted Dresses.



No. 61/669.

- 61/666.
- 61/667.
- 61/668.
- 61/669.
- 61/671.

Dozen.

Length, 5¼ in. ½ dozen in package	\$2 50
Length, 6 inches. ½ dozen in package	3 00
Length, 7 inches. ½ dozen in package	3 50
Length, 7¼ in. ½ dozen in package	4 00
Length, 9½ in.	7 20

"Whistling Charley."

- 61/696.

Dozen.

A rubber model of this famous work. Length, 7¼ inches. ½ dozen in box	\$3 60
---	--------

Rubber Animals.

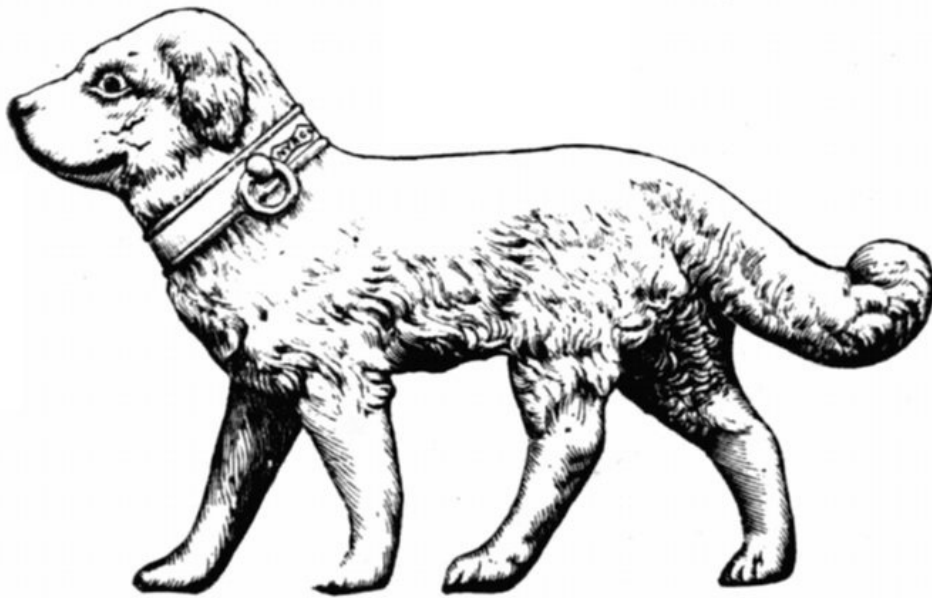

No. 61/699.

61/678. Assorted

61/699.

Dozen.

animals. Average height, $3\frac{1}{4}$ inches \$3 80

As above. Average height $4\frac{1}{4}$ in. 7 20

DOLL HEADS.

NOTE.—Sizes given are: first, the height, then width across shoulders.



Glazed China, painted hair and eyes.

236²/0.

236/0.

236/1.

236/2.

236/3.

236/4.

Dozen.

Size, $2\frac{3}{4} \times 2\frac{1}{2}$ inches, 1 doz. in box \$0 80

" $3 \times 2\frac{3}{4}$ " 2 " 1 00

" $3\frac{1}{4} \times 3$ " 1 " 1 30

" $3\frac{1}{2} \times 3\frac{1}{8}$ " $\frac{1}{2}$ 1 60

" $3\frac{3}{4} \times 3\frac{1}{2}$ " $\frac{1}{2}$ 1 80

" $4 \times 3\frac{1}{2}$ " $\frac{1}{2}$ " 2 20

236/5.
 236/6.
 236/7.
 236/8.

"	"	$4\frac{1}{2} \times 3\frac{3}{4}$	"	$\frac{1}{2}$	2 80
"	"	$4\frac{3}{4} \times 4$	"	$\frac{1}{3}$	3 50
"	"	$5\frac{1}{4} \times 4\frac{1}{4}$	"	1	4 00
"	"	$5\frac{3}{4} \times 4\frac{3}{4}$	"	1	4 50



Bisque head, Mohair Curls, fine glass eyes.

32.
 33⁴/0.
 33³/0.
 33²/0.
 33/0.
 33/1.
 33/2.
 33/4.
 33/6.

Dozen.

Size, $3\frac{1}{4} \times 2\frac{1}{4}$ inches,	\$1 60
1 dozen in box	
" " $3\frac{1}{4} \times 2\frac{3}{4}$ " 1	2 40
" " $3\frac{3}{4} \times 3$ " $\frac{1}{2}$ "	3 20
" " $4 \times 3\frac{1}{4}$ " $\frac{1}{2}$ "	3 60
" " $4\frac{1}{4} \times 3\frac{1}{2}$ " $\frac{1}{2}$ "	4 00
" " $4\frac{1}{2} \times 3\frac{3}{4}$ " $\frac{1}{8}$ "	4 50
" " $4\frac{3}{4} \times 4$ " $\frac{1}{3}$ "	5 50
" " $5 \times 4\frac{1}{4}$ " $\frac{1}{12}$ "	6 50
" " $5\frac{1}{4} \times 4\frac{1}{2}$ " " "	8 00
1/12 " " " " "	

Dolls in Perambulators.

Crying Voice.



No. 234/65.

Dressed doll in fancy trimmed wicker perambulator. As it is wheeled along the doll moves its arms and legs and cries.

234/65.

234/66.

Dozen.

Length, 12 inches; \$11 00
 Height, 8 inches
 " 16 " " 10 " 24 00

WAR

GAME

MOST POPULAR PARLOR GAME OF THE SEASON

FASCINATING!
ENTERTAINING!
SCIENTIFIC!

 EMPLOYS
 GENERALS,
 INFANTRY,
 CAVALRY,
 ARTILLERY.

MOVEMENTS & MANŒUVRES

CLOSELY ANALOGOUS TO

REAL WARFARE

AS A GAME OF SKILL

 IT IS SUPERIOR TO
 CHESS OR CHECKERS

 VERY EASY TO LEARN

WAR GAME

**MOST POPULAR PARLOR GAME of the SEASON
 FASCINATING! ENTERTAINING! SCIENTIFIC!
 EMPLOYS
 GENERALS INFANTRY. CAVALRY. ARTILLERY.
 MOVEMENTS & MANŒUVRES CLOSELY ANALOGOUS TO REAL WARFARE
 AS A GAME OF SKILL IT IS SUPERIOR TO CHESS OR CHECKERS VERY EASY
 TO LEARN**

War Game, each complete in box with board and men

Dozen.

\$4 00

CHINAWARE.

**In the following pages we list a few leading values picked from the largest and
 choicest range of Fancy China we have ever shown.**

CUPS AND SAUCERS.



No. 152/211.

152/211.

Dozen.

As cut. Cup is 2¾ inches high and 3 inches wide; has three assorted flower decorations, rococo embossing and gold edge; 1 dozen in package

\$ 1 60

140/56.

Similar to 152/211. Cup is 3 inches high and 3 inches wide; has spray of pink and yellow roses and heavy clouded gold edge; ½ dozen in package

2 70



No. 152/212.

152/212.

Dozen.

As cut. Cup is 2¾ inches high and 2½ inches wide; decorated with wide gold band and assorted flowers and mottos; 1 dozen assorted in package

\$ 1 70

152/123.

Similar to 152/212. Size of cup, 2¾ × 2¾ inches. Lithographed figure decoration, gold edge; 1 dozen assorted in package

1 80



No. 120/42.

120/42.

Dozen.

As cut. Size of cup, 2¾ inches high and 3 inches wide. Decorated with spray of hedge roses, rococo embossing and gold edge; 1 dozen in package \$ 2 00



No. 152/251.

152/251.

Dozen.

As cut. Cup is 3¼ inches high and 3½ inches wide. Has rococo embossed top, pretty flower decoration with motto, gold edge line; ½ dozen assorted in package \$ 2 40

152/251M. Moustache

cup and saucer as above; ½ dozen in package 2 50

152/252.

As cut 152/251 but larger, size of cup being 3½ × 3½ inches. Has three assorted motto decorations, solid gold handle and heavy clouded gold edge; ½ dozen assorted in package 3 60

152/252M. Moustache

4 00



No. 120/36.

120/36.

120/36M. Moustache

Dozen.

As cut. Size of cup, $2\frac{3}{4} \times 3\frac{1}{2}$ inches. Good quality German china, embossed border, hand painted flower decoration, heavy splash clouds of gold on edge. Each cup stamped "Dresden," with crown trade mark; $\frac{1}{2}$ dozen in package cup and saucer as above; $\frac{1}{2}$ dozen in package

\$ 3 60

4 00



No. 83/162M.

83/162M. Moustache

83/163.

Dozen.

cup and saucer as cut. Best quality China, rococo embossed panels, pretty Daisy wreath with delicate color tint, splash clouds of gold inside and outside top edge; $\frac{1}{2}$ dozen in package

\$4 00

As above but ladies' style, being without moustache bridge; $\frac{1}{2}$ dozen in package

3 60



No. 83/164M.

83/164M. Moustache

83/165.

cup and saucer as cut. The same fine quality as our 83/162M. Has three different flower decorations, embossed base, gold edges; ½ dozen assorted in package

\$4 00

Ladies' cup and saucer as above; ½ dozen in package

3 60



No. 196/227.

196/227. Ladies' Tea.

196/224.

83/167.

As cut. Fine quality thin China. Cup is 2½ inches high and 3 inches wide. Has embossed base border, "Violet" flower decoration and polished gold edge; ½ dozen in package

\$4 50

Similar to above. Size of cup 2¾ × 3¼ inches. Rich flower decoration, embossed clouded gold edge; ½ dozen in package

4 00

Similar to 196/227. Cup is 2¼ inches high and 3¼ inches wide

4 00



196/70.

196/221.

196/222.

196/223.

Dozen.

Fancy tea on four feet, thin transparent china with green spray flower decoration, gilt handle and feet; ½ dozen in package \$4 50
 Same shape as above, tea size. Has shaded tint border and "Forget-me-not" spray, solid gold handle and feet; ½ dozen in package 4 50
 Similar to above, shell shape. Has pretty flower garland decoration, solid gold handle and feet; ½ dozen in package 4 50
 As 196/222 but has "Violet" decoration; ½ dozen in package 4 50

"Elysee" Shape.



No. 374/49.

374/49.

374/45.

374/44.

374/46M. Moustache

Dozen.

As cut, 5 o'clock tea. Fine quality thin transparent china. rococo embossed; heliotrope flowers and green leaves on delicate salmon tint background. The decoration extends completely around the cup, and also has spray inside and on saucer; ½ dozen in package 3 60
 As above but tea size (cup is 2½ inches high and 3½ wide); ½ dozen in package 4 00
 As above but coffee size; ½ dozen in package 4 50
 cup, is 2½ inches high and 4 inches wide; ½ dozen in package 7 20



No. 196/278.

196/278.

maroon tint,

196/258.

Bread and Butter Plates to match above as follows:—

196/277. Maroon tint.

196/257. Turquoise green tint.

We have also in stock to match above tint decorations, Teapots, Sugars and Creams, Chocolate Pots, Cake Plates, Salads and Cracker Jars.

Dozen.

Tea cup and saucer. As cut. Solid embossed and gold traced wreath; flower decoration; polished gold handle and edges; ½ dozen in package \$ 8 00
 Same as above, but in solid turquoise green tint; ½ dozen in package 8 00
 Diameter 5½ in.; ½ dozen in package \$ 4 00
 Diameter 5½ inches; ½ dozen in package 4 00

A. D. Cups and Saucers.

After Dinner Size. Fancy Footed Shapes.



No. 312/4.

Dozen.

212/4.

212/2.

212/3.

212/7.

As cut. Assorted in three tints, rich gold bead decoration, gold top band; 1 dozen assorted in package \$ 3 60
 Similar to above, assorted in three shaded tints and rich gold decorations; 1 dozen assorted in package 3 60
 Maroon tint, heavy gold rim, two rows of gold beads, assorted color base border; 1 dozen assorted in package 3 60
 Solid gold, assorted in three shapes; 1 dozen in package 3 60

E. L. & S. WARE.



No. 207/1466.

207/1466.

208/1466.

208/1466.

Dozen.

Tea cup and saucer. As cut. Good quality German china with gold edge, line and sprig. Cup is 3 inches high and 3¹/₈ inches wide; ½ dozen in package

\$ 2 50

Coffee cup and saucer as above. Size of cup, 3¹/₂ × 3⁵/₈ inches; ½ dozen in package

3 60

As above, but with **moustache** bridge; ½ dozen in package

4 00

E. L. & S. Plates.

G3/1466.

Dozen.

7¹/₂ inch diameter, in gold edge, line and sprig decoration to match above cups and saucers; ½ dozen in package

\$ 2 50

E. L. & S. Cream Jugs.

176/1466.

123/1466.

129/1466.

106/1466.

Dozen.

White china jug with gold edge, line and sprig decoration to match above. Height, 3³/₄ inches; ½ dozen in package

\$ 1 70

As above. Height, 4¹/₂ inches; ½ dozen in package

2 20

As above. Height, 5¹/₄ inches; ½ dozen in package

3 00

As above. Height, 5¹/₂ inches and is stouter shape; ½ dozen in package

3 60

Semi-Porcelain Ware.

British Make. E. L. & S. Decoration.

"Paris"

Dozen.

shape, tea cup and saucer, good quality, gold line and sprig

\$1 80

"Tall"
6-inch

decoration
shape, tea cup and
saucer as above 1 80
plates as above 1 30

Cup, Saucer and Plate Sets.



No. 120/29.

Dozen Sets.

52/2131.

Child's Cup, Saucer and Plate Set. Cup is 2¾ × 2¾ inches. Plate is 6¼ inch diameter. Pretty Marguerette decoration, gold edge; 1 doz. in package \$3 00

120/29.

As cut. Cup is 2¾ inches high, and 3¼ inches wide. Plate is 7½ inch diameter. Pink rose decoration, gold edge; ½ dozen in package 3 50

152/214.

Fancy shape cup. Size, 2¾ inches high, and 3½ inches wide. Plate is 7 inch diameter. Embossed and with lillies-of-the-valley, gold edge; ½ doz. in package 4 00

401/½.

Low shape thin cup 2½ × 3¾ inches. Plate 8 inch diameter. Embossed and with assorted flower decorations; ½ dozen in package 4 50



No. 374/44.

374/44. "Elysee"

140/94/95.

Dozen Sets.

shape as cut. Cup is 2¼ inches high, and 3¼ inches wide. Plate is 7½ inch diameter. Fine quality china, decorated with heliotrope flowers and green leaves on delicate salmon tint background, gold edge; ½ dozen in package

8 00

Similar to above. Very thin china; light green border, gold lace pattern, dark green in parts and garlands of pink roses; ½ dozen in pkg.

11 00

Porridge Sets.



152/220.

405/3.

152/221.

Dozen Sets.

Three piece set consisting of 6¼ inch plate, 4¼ inch bowl and pitcher 5 inches high. Neat embossing, assorted flowers and gold edge; ½ doz. sets in package

\$ 4 00

Similar to above, but larger size and finer decoration; ½ dozen sets in package

6 00

Fancy low shape pitcher, 4 inches high, 5½ inch bowl and 7 inch plate. Tinted border in three assorted colors, neat embossing, flower decoration and gold edge

7 20

Children's Mugs.



No. 152/231.

152/228.

Dozen.

Color band at top, assorted flowers and mottoes. Height, 2½ inches; diameter, 2½ inches; 1 dozen in pkg. Clouded gold top band,

\$ 0 80

152/229.

children's faces in lithograph colors. Height, 2¾ inches; diameter, 2¾ inches; 1 dozen in package

120/85.

Flower decoration, gold splashes. Height, 2¾ inches; diameter, 3 inches; 1 dozen in package

152/231.

Wide gold top band, gold handle, flower decoration. Height, 3 inches; diameter, 3 inches; 1 doz. in package

152/232.

Shaded maroon ground with flower decoration, clouded gold top band. Height, 3 inches; diameter, 3 inches; ½ dozen in package

Tea, Sugar and Creams.



No. 374/47.

Dozen Sets.

196/237.

Low shape teapot, open sugar bowl, and cream pitcher. Pretty flower decoration and clouded gold edges \$8 00

Tea cup and saucer to match above, No. 196/224 at \$4.00 dozen.

374/47.

Elysee shape. As cut. Fine quality china, decorated with heliotrope flowers and green leaves on delicate salmon tint ground, gold edges 14 40

Tea cup and saucer to match above, No 374/49 at \$3.60 dozen.

3/175.

Similar to cut 374/47. Light green tint ground, rich flower decoration, embossing and gold tracing 15 00

Tea cup and saucer to match above, No. 3/176 at \$4.80 a dozen.

Five O'Clock Tea Sets,

On China Trays.



Dozen Sets.

236/16.

Fancy low shape pieces. Ten piece set. Tray, 9½ inch diameter, and teapot, 4 inches high. Shaded pink tint, gold edges 8 00

2/134.

Fancy shapes. Nine piece set. Tray 8½ inch diameter, and teapot is 5 inches high. Rose spray decoration, gold edge 12 00

TABLE SETS.



No. 152/244.

Per Set.

152/244.

As cut. Six piece set. Neatly embossed and Chrysanthemum flower decoration. 1 set in package \$1 10

3/179.

Fine quality china. Embossing and rich green flowers, lustre tint, gold tracing. 1 set in package 2 60

Butter Dishes.

Dozen.

152/237.

As in set 152/244 above. Three assorted flower decorations. Diameter, 7¾ inches. ½ dozen in package \$4 00

152/238.

As above. Maroon tint, colored flower spray and gold traced embossing. ½ dozen in package 7 20

Cream Jugs.



No. 152/223.



No. 196/231.



No. 196/232.

Dozen.

152/222.	Same shape as cut 152/223. Three assorted flower decorations, embossed top and base. Height, 4 inches. 1 dozen in package	\$0 90
152/223.	As cut. Three assorted flower decorations, embossed top and base. Height, 5 inches, ½ dozen in package	1 60
152/221.	As above. Height, 6 inches. ½ dozen in package	2 40
152/225.	As above. Height, 6¾ inches. ½ dozen in package	3 20
196/231.	As cut. Fine quality china, scalloped top. Decorated with sweet clover blossoms, clouded gold top and handle. Height, 5¾ inches. ½ dozen in package	4 00
196/232.	As cut. Fine quality china, neatly embossed, assorted flower decoration, gold edge and handle. Height, 5¾ inches. ½ dozen in package	4 00

BERRY SETS.

All 13 Piece Sets.



**No. 196/235.
Per Set.**

152/245.	Similar to cut. 9¾ inch bowl and twelve 5¼ inch nappies. Pink flower decoration, embossing, gold edge; 1 set in package	\$ 1 50
152/246.	As above, but "Lily-of-the-Valley" decoration; 1 set in package	1 50
196/233.	Fine quality china; same shape as cut. 9 inch bowl and 5 inch nappies. "Violet" decoration, clouded gold edge; 1 set in package	2 00
196/234.	As above, but light green tint and green spray of flowers. A favourite seller; 1 set	2 00

196/235.

in package
As cut. Has 9 inch bowl
and 5 inch nappies.
Decorated with sky
blue tint border, sprays
of pink flowers, neat
embossing and gold
edge; 1 set in package
Larger than above.
Maroon tinted edge
with rich gold tracing,
large spray of flowers;
1 set in package

152/247.

Salad Bowls.

Dozen.

152/250.

Diameter, 9¾ inches.
Fancy embossed edge,
with wide clouded gold
border. Three assorted
flower decorations; ¼
dozen in package

3/184.

Diameter, 9¾ inches.
Flower embossed edge,
yellow and pink lustre
tint, with spray of
Violets

3/185.

Diameter, 10 inches.
Fancy leaf shape,
tinted in parts, rich
flower decoration and
gold tracing

Have also better lines of Salad Bowls in newest shapes and decorations up to \$22.00 dozen (list).

CAKE PLATES.



No. 152/218.

Dozen.

Same shape as cut.
Large spray of flowers
in three assorted
colors, neat embossing,
\$ 3 00

120/73.

152/217.	gold edge, open handle. Diameter, 9 inches; ½ dozen assorted in package Embossed rim, "Lily-of-the-Valley" decoration, gold tracing and edge, open handles. Diameter, 9½ inches; ½ dozen in package	4 00
402/6.	Flower decoration in three assorted colors, neat embossing, gold fern border and edge; open handles. Diameter, 10½ inches; ½ dozen in pkg.	7 50
152/218.	As cut. Yellow lustre finish, green and gold tracing on embossed border. Large spray of hand-painted flowers. Diameter, 10¾ inches; ½ dozen in package	9 00
120/81.	Fine quality china; gold covered relief embossed border and large spray of hand painted roses. A very rich pattern. Diameter, 10¾ inches; 1/12 dozen in package	13 00

We also carry in stock finer Cake Plates up to \$24.00 dozen (list.)

Where number in package is mentioned we cannot sell a smaller quantity.

MUSTARD POTS.

With Spoons.



No. 152/241.

9/12.	Dozen. Barrel shape, 3 inches high, pink lustre finish; 1 dozen in package	\$0 70
152/204.	Barrel shape, 3½ inches high, assorted flowers, and clouded gold edge; 1 dozen in package	1 30
152/241.	As cut, 4½ inches high. Assorted flowers, clouded gold edge; 1 dozen in package	1 60

Sick Feeders.

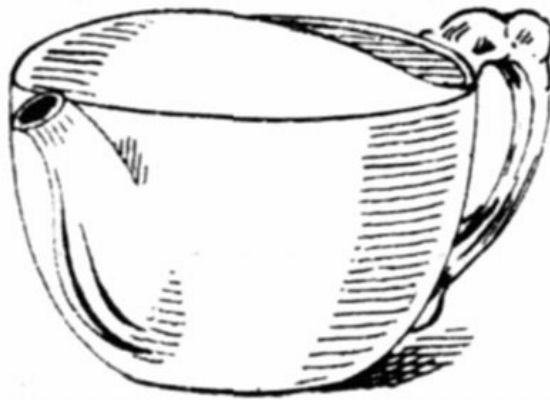

No. A/1145.

5/8.

A. White.

A/1145.

Dozen.

Plain white china. Diameter of bowl 3 inches; ½ dozen in package	\$2 20
As above, but ¾ inch diameter	4 00
As above, but with gold lines	4 50

Egg Cups.



Nos. 100.



99/151.



102.



1194.

102.

100.

99/151.

Gross.

As cut. Ribbed, with two gold lines, 2¼ inches high; ½ gross in package	\$3 50
As cut. Plain, with gold lines, 2½ inches high; ½ gross in package	3 60
As cut. Plain, with gold lines, 2⅝ inches high; ½ gross in package	4 00

Double Shape.

1194.

As cut. Plain white, 3⅝ inches high; 1 dozen in package	1 10
---	------

2003.

As 1194, but has broad gold base and gold lined top; 1 dozen in package

1 20

89/11.

Ribbed, with broad gold base and gold line top, 4 inches high; 1 dozen in package

1 60

SHAVING MUGS.



No. 196/245.

3W.

Dozen.

Plain white china Barber's mug. Size, 3½ × 3½ inches; ½ dozen in pkg.

\$1 60

152/235.

Flat shape, divided top soap receptacle, flower decoration. Height, 2½ inches; diameter, 3¾ inches; 1 dozen in package

2 20

152/233.

Same shape as cut 152/234, clouded gold top, flower decoration. Height, 3¾ inches; ½ dozen in package

2 40

196/245.

As cut. Fancy shape, clouded gold edge, flower decoration. Height, 4¼ inches; ½ dozen in package

4 00



No. 152/234.

152/234.

Dozen.

As cut. Clouded gold top, large size gold lined soap receptacle, flower decoration. Height, 4 inches; ½ dozen in package

\$6 00

Soap Dish.

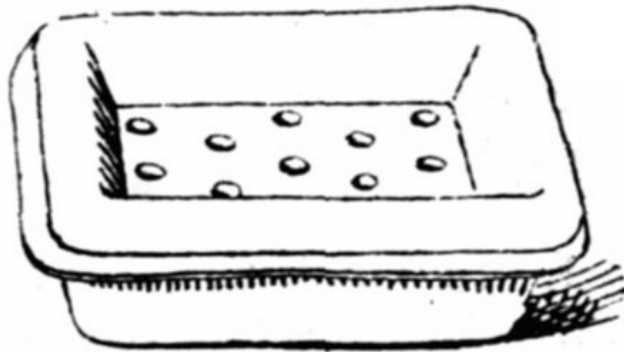

No. 1302.

1302.

Dozen.

As cut. Two piece, white china. Size, 4¾ × 3½ inches; ½ dozen in package

\$2 40

SOUVENIR CHINA.

"Queen's Ware," a new and striking emblem design comprising a portrait of the Queen and each Provincial Coat of Arms, all in bright colors.

SAMPLE THIS LINE



**IT IS A FAVORITE
No. 196/427.**

**Each piece of following lines has above emblem design in addition to
decoration mentioned.**

Trays.

196/400.

Dozen.

Oblong shape; clouded gold edge. Size, 5 x 2¾ inches; 1 dozen \$ 3 00 in pkg.

196/402.

Leaf shape; crimped and clouded gold edge. Size, 5 x 4 inches; 1 dozen 3 60 in package

196/401.

Fancy hexagon shape; scalloped and clouded gold edge. Diameter, 5 inches; one dozen in 3 60 package

Teapot Stand.

196/419.

Round shape; 6½ inches in diameter, scalloped and clouded gold edge, gold traced wreath; ½ dozen in \$4 00 pkg.

Plates.

196/407.

5¼ inch; clouded gold edge, embossed; 1 dozen in package \$ 3 00

196/410.

6 inch; wide maroon border, clouded gold edge, gold traced wreath; 1 dozen in 5 50 package

196/409.	6 inch; light green border, otherwise same as above; 1 dozen in pkg.	5 50
196/412.	6 inch; wide maroon border, gold lines and filigree work over color; 1 dozen in package	5 50
196/427.	7¼ inch; as cut. Clouded gold edge; ½ dozen in package	5 50

Bread or Cake Plates.

Dozen.

196/429.	11 inch; clouded gold edge, gold traced wreath	\$12 00
199/430.	11 inch; cobalt blue, clouded gold edge	24 00

Cups and Saucers.

196/413.	Clouded gold edges. Size of cup, 3 × 3 inches; ½ dozen in package	\$ 4 00
196/415.	Clouded gold edges. Flare top cup, size, 2¾ × 3¼ inches; ½ dozen in package	5 50

Cream.

196/418.	Clouded gold edge; 4 inches high; ½ dozen in package	\$ 3 00
----------	--	---------

Vases.

196/423.	Footed oval shape; clouded gold edge; 4½ inches; ½ dozen in package	\$ 4 00
196/421.	Handled urn shape; clouded gold; ½ dozen in package	4 00
196/424.	Similar to above but has cover; 6½ inches high	8 00

GLASS FLOWER TUBES.

Finest Quality Bohemian Ware.

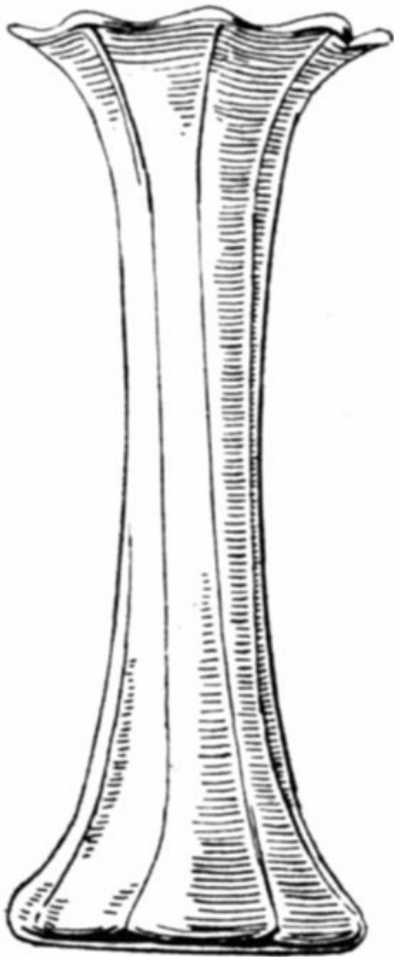

No. 7607 shape.

Crystal, scalloped top.



No. 814.

7607/4½.

7607/6.

7607/8.

7607/10.

7607/12.

7607/14.

814. 4½

Dozen.

-inch, ½ dozen in package	\$1 60
- " ⅙ " "	2 00
- " ⅙ " "	3 00
- " ⅙ " "	4 00
- " ⅙ " "	7 20
- " ⅙ " "	10 80
inches high, crystal, footed, engraved fern decoration, ½ dozen in package	\$2 40

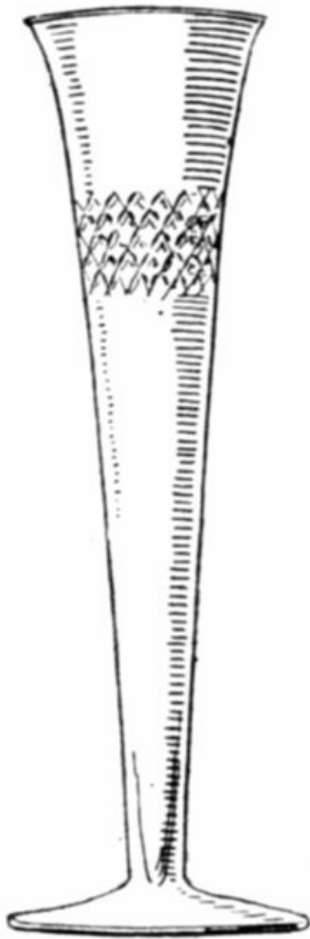

No. 7271 shape.

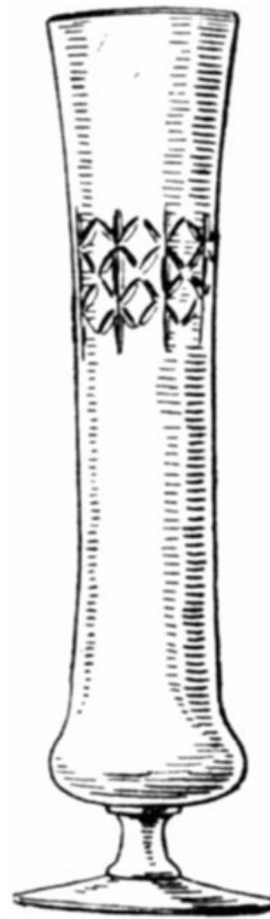

No. 7324 shape.

Crystal, footed, cut decoration.

7271/4½.
 7271/6.
 7271/8.
 7271/10.
 7271/12.
 7324/4½.
 7324/6.
 7324/8.
 7324/10.
 7324/12.

Dozen.

-inch, ½ dozen in	\$3 00
package	
- " ⅙ " "	4 00
- " ⅙ " "	5 50
- " ⅙ " "	7 20
- " ½ " "	10 80
- " ⅙ " "	3 00
- " ⅙ " "	4 00
- " ⅙ " "	5 50
- " ⅙ " "	7 20
- " ⅙ " "	10 80

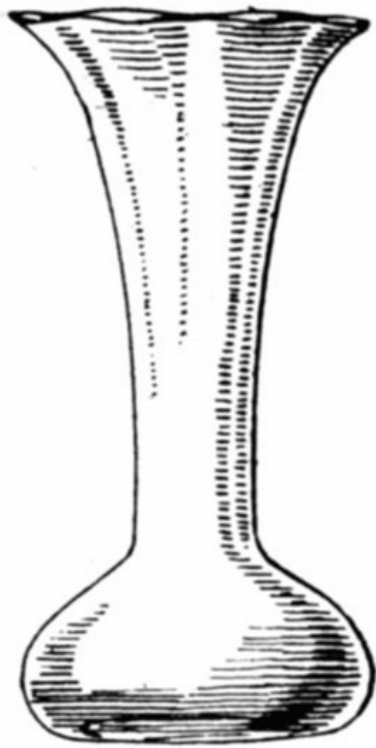

No. 7606 shape.

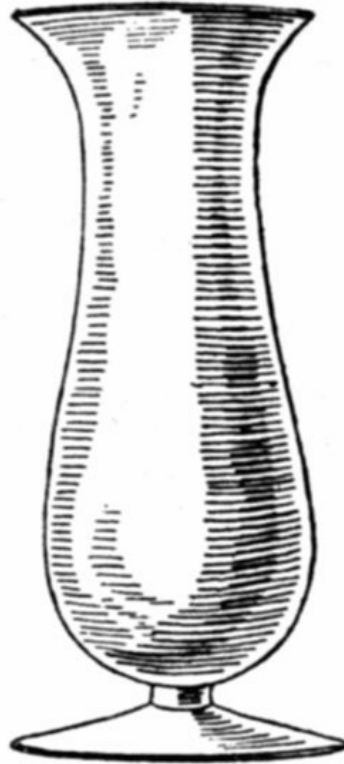

No. 8412 shape.

Green, globe bottom, scalloped top.

7606/6.

7606/8.

7606/10.

7606/12.

Dozen.

-inch, 1/6 dozen in package	\$2 40
- " 1/6 " "	4 00
- " 1/6 " "	5 50
- " 1/6 " "	8 00

Iridescent Lustre Crystal, footed.

8412/4 1/2.

8412/6.

8412/8.

-inch, 1/6 dozen in package	\$2 50
- " 1/6 " "	3 60
- " 1/6 " "	4 80

Glass Flower Bowls.

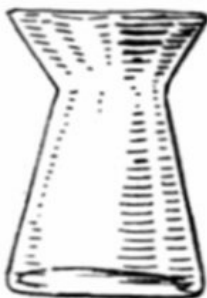
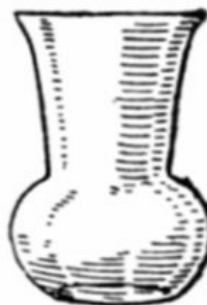
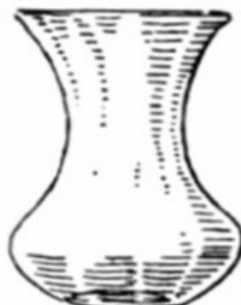

No. 307 Assortment.

307.

Gross.

Assorted, six shapes,
crystal, 3 inches high,
½ dozen each kind in
package \$ 9 60



No. 000.

7688A/7690A.

Dozen.

Assorted four shapes,
crystal, 4 inches high,
½ dozen in package \$ 2 40

WATER SETS.

All are six tumbler sets.



No. 231/10.

A1.

Dozen Sets.

Bohemian Crystal,
consisting of tall
pitcher and six
tumblers. Decorated \$18 00
with blue band, gold
lines and fancy enamel
patterns

231/10.

As cut. A very rich
Green Bohemian glass
set, decorated with 21 60
white enamel figures,
gold lines

Per Case.

of Bohemian glass sets.
Contains ten six

A10. Assortment

tumbler sets in different shaped jugs and pretty decorations. The assortment comprises, 2 crystal, 3 moss green, 2 blue, 1 dark green and 2 ruby colored sets. Retail values range from 75c to \$2.00 each. Sold only in full cases of ten sets 21 00

Glass Vase.

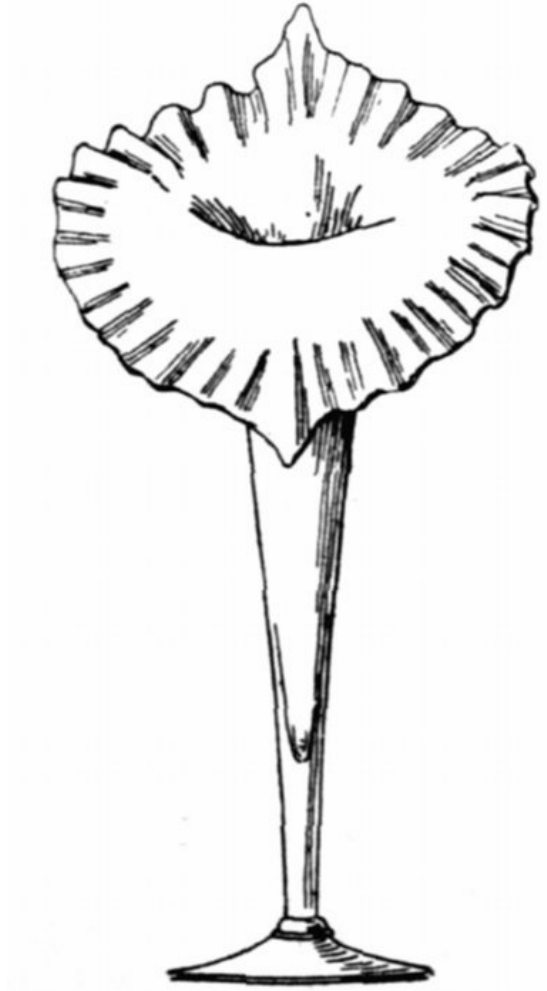

No. 392.

392 Assortment,

Dozen.

11 inches high, footed, plain and crimped lily top, four colors assorted \$ 4 00

GLASS TABLE SETS.

All are six piece sets.



**No. 231/110.
Per Set.**

231/110.	As cut. Bohemian crystal, decorated with gold bands, and gold and enamel lace pattern, gold base and edge line. 1 set in package	\$1 50
231/104.	Similar to above, but richer decoration. 1 set in package	2 00
231/103.	Green Bohemian glass, same shape and similar decoration to cut 231/110. A favorite seller. 1 set in pkg.	2 00
231/12.	Green colored set, similar to above, but richer gold and enamel decoration	2 50
231/11.	Shaded ruby, lustre finish. Wide gold band, rich gold and colored enamel flower decoration	2 50
231/13.	Pink tint, frosted, heavy gold bands and sprays of flowers in enamel and gold	3 00

Glass Centres.

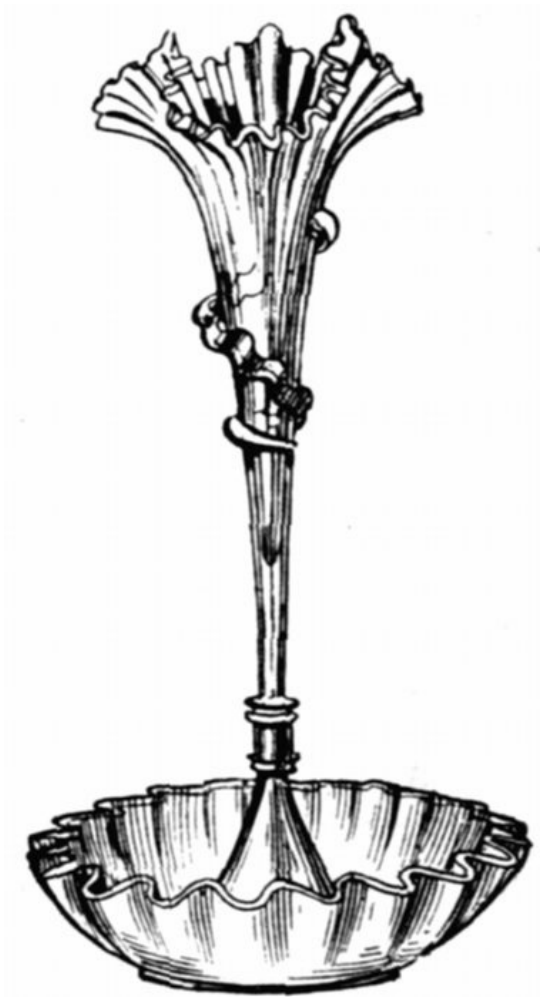

No. 742.

742.

286A.

700.

622.

Dozen.

As cut, assorted colors, height 15 inches \$14 40

Similar to 742, but 16 inches high 16 00

Similar in style and size to above, but has two hanging basket ornaments 33 60

A very handsome and large centre, one tall and three shorter branches; entire height, 19 inches 36 00

TUMBLERS.

No charge for cases on Blown Tumblers in full case lots.

Bell Shape, Blown.

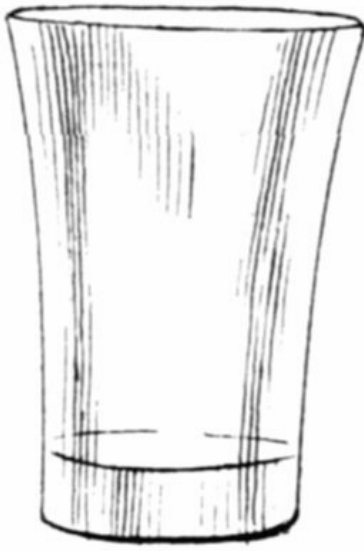

No. 705/41H.



No. 709/53.

204/24.		-2 oz. Light	Dozen, \$ 1 00
	Case lots of 25 dozen, gross, \$10 50.		
205/27.		-2½ oz. Heavy	Dozen, \$ 1 10
	Case lots of 25 dozen, gross, \$11 50.		
205/31.		-3 oz. Light	Dozen, \$ 1 00
	Case lots of 12 dozen, gross, \$10 80.		
205/31H.		-3 oz. Heavy	Dozen, \$ 1 10
	Case lots of 12 dozen, gross, \$12 00.		
701/35.		-5 oz. Light	Dozen, \$ 1 00
	Case lots of 12 dozen, gross, \$11 00.		
701/35H.		-5 oz. Heavy	Dozen, \$ 1 10
	Case lots of 12 dozen, gross, \$12 00.		
702/36.		-6 oz. Light	Dozen, \$ 1 10
	Case lots of 12 dozen, gross, \$11 50		
702/36H.		-6 oz. Heavy	Dozen, \$ 1 20
	Case lots of 12 dozen, gross, \$12 50.		
703/40.		-7 oz. Light	Dozen, \$ 1 10
	Case lots of 12 dozen, gross, \$12 00.		
703/40H.		-7 oz. Heavy	Dozen, \$ 1 20
	Case lots of 12 dozen, gross, \$13 00.		
705/41.		-8 oz. Light	Dozen, \$ 1 20
	Case lots of 12 dozen, gross, \$12 50.		
705/41H.		-8 oz. Heavy	Dozen, \$ 1 30
	Case lots of 12 dozen, gross, \$13 50.		
706/42.		-9 oz. Light	Dozen, \$ 1 30
	Case lots of 12 dozen, gross, \$14 00.		
706/42H.		-9 oz. Heavy	Dozen, \$ 1 40
	Case lots of 12 dozen, gross, \$15 00.		
707/44.		-10 oz. Light	Dozen, \$ 1 40
	Case lots of 12 dozen, gross, \$15 50.		
707/44H.		-10 oz. Heavy	Dozen, \$ 1 50
	Case lots of 12 dozen, gross, \$16 80.		
709/53.		-12 oz. Light	Dozen, \$ 1 50
	Case lots of 12 dozen, gross, \$16 80.		
709/53H.		-12 oz. Heavy	Dozen, \$ 1 60
	Case lots of 12 dozen, gross, \$18 50.		

Taper Shape, Blown.

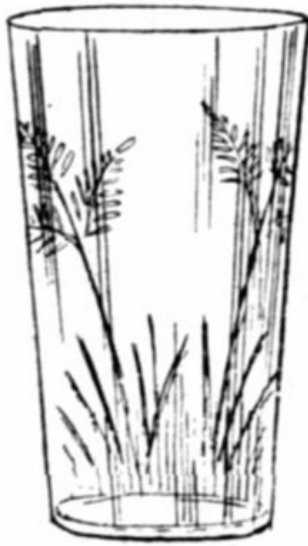

No. 5C.

109/30.

Case lots of 25 dozen, gross, \$9 50.

5 Plain.

5 C.

5/84.

-2 oz. tumbler Doz. \$ 0 90

Champagne tumbler. Dozen, \$0 84

-Champagne tumbler, engraved fern decoration, Dozen, \$ 1 30

-Champagne, engraved lace drop decoration Dozen, \$ 1 80

Straight Shape, Blown.

602/36.

Case lots of 12 dozen, gross, \$12 00.

4/C.

4/84.

-9 oz. Table tumbler Dozen, \$ 1 10

-9 oz. Table tumbler, engraved fern decoration Dozen, \$ 1 60

-9 oz. Table tumbler, engraved lace drop decoration Dozen, \$ 2 00



No. 4/84.

Straight Optic.

4 Ruby.

-9 oz. Table tumbler Dozen, \$ 1 80

Cut Tumblers.



No. 7/95½.

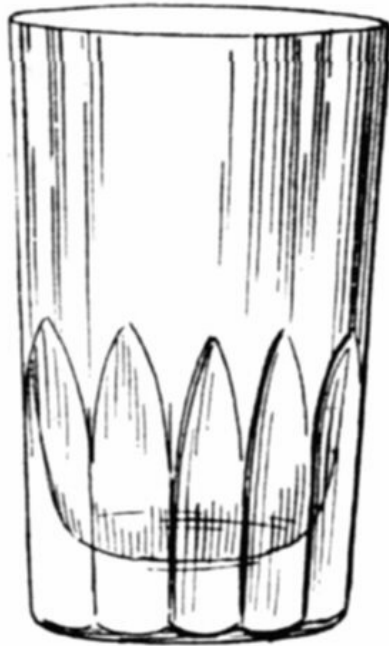

No. D1/5.

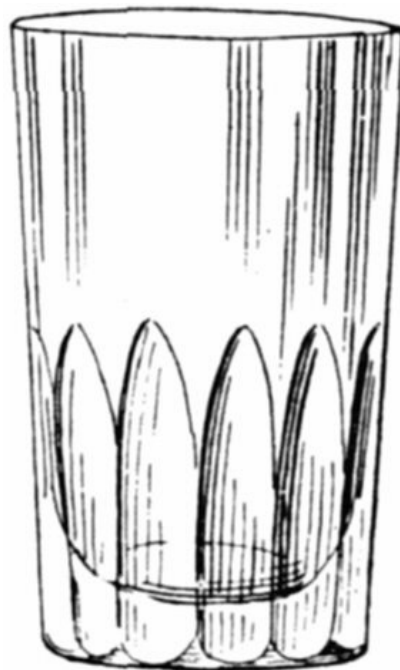

No. 1½.

7/95½.

D1½/5.

1½.

1F.

Case lots of 25 dozen, gross, \$21 60.

Case lots of 12 dozen, gross, \$32 40.

Case lots of 12 dozen, gross, \$45 00.

-5 oz. Half
Crystal Dozen, \$ 2 00

-8 oz. Half
Crystal Dozen, \$ 2 20

-10 oz. Half
Crystal Dozen, \$ 3 00

-10 oz. Full
Crystal Dozen, \$ 4 00



No. 3½.



No. 4½.

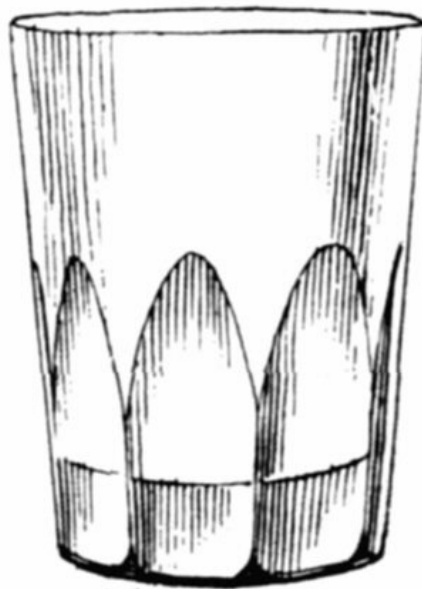

Cut Belgium.

3½.	Case lots of 12 dozen, gross, \$32 40.	-7 oz. Half Crystal	Dozen, \$ 3 00
3.	Case lots of 12 dozen, gross, \$45 00.	-8 oz. Full Crystal	Dozen, \$ 4 00
4½.	Case lots of 12 dozen, gross, \$36 00.	-10 oz. Half Crystal	Dozen, \$ 3 30
4.	Case lots of 12 dozen, gross, \$50 00.	-10 oz. Full Crystal	Dozen, \$ 4 50
Cut Belgium.	Case lots of 12½ dozen, gross, \$60 00.	11 oz. Full Crystal	Doz., \$ 6 00

STEM GLASSES.

LIQUEURS.



No. 704C.

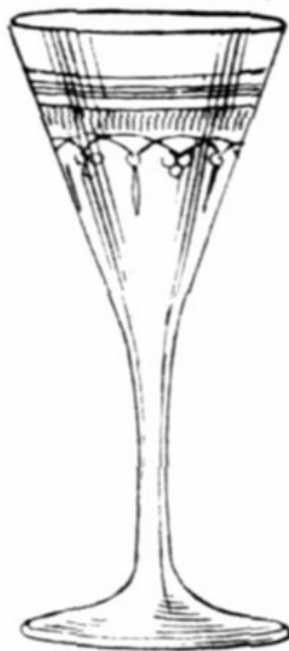

No. B.84.

822C/9.	Plain.	Dozen, \$ 1 40
704C.	Fern decoration "	1 60
704/84.	Lace drop decoration	1 80
	"	"

B.3.
B.84.

As B.84 but plain " 1 80
As cut, lace drop
decoration " 2 80

SHERRIES AND PORTS.



No. 5765.



No. 703C.

5765.
5765P.

Above two lines in assorted case, 18 Sherries and 7 dozen Ports

703. ,

L/1.

703C. ,

L1/C.

Sherry	Dozen.	\$ 0 90
Port	"	90
	Per	10 00
	Gross,	
Sherry Plain	Dozen,	1 70
Port to match	"	1 80
Sherry Fern	"	2 10
decoration		
Port to match	"	2 10
703C		



No. L/1/84.



No. 802/13.



No. 801/62.

703/84. ,

L/1/84.

801/62. ,

802/13.

Sherry Lace drop decoration	Doz., \$	2 40
Port to match 703/84	"	2 40
Sherry Plain	"	1 60
Port to match 801/62	"	2 40

HOT WHISKIES.



No. 800C/9.

42/2.

800C/9.

Plain	Dozen, \$	2 00
Plain	"	2 20

COCKTAILS.



No. 821.



No. 8005/84.

820.

821.

Plain
Engraved

Dozen \$ 2 40

" 2 70

SAUCER CHAMPAGNES.

8005.

8005/84.

Plain
Lace drop
decoration

Dozen \$ 2 90

" 4 00

HOCKS.



No. 42/2.



No. 1202BA.

42/2O.
42/2R.
42/2G.
1202C.
1202BA.,
1202G. ,

Orange Color	Dozen, \$	4 00
Ruby "	"	4 00
Green "	"	4 00
Claret , Plain	"	2 00
Bass Ale Plain	"	2 40
Goblet Plain	"	2 70

WIRE PLATE HANDLES.

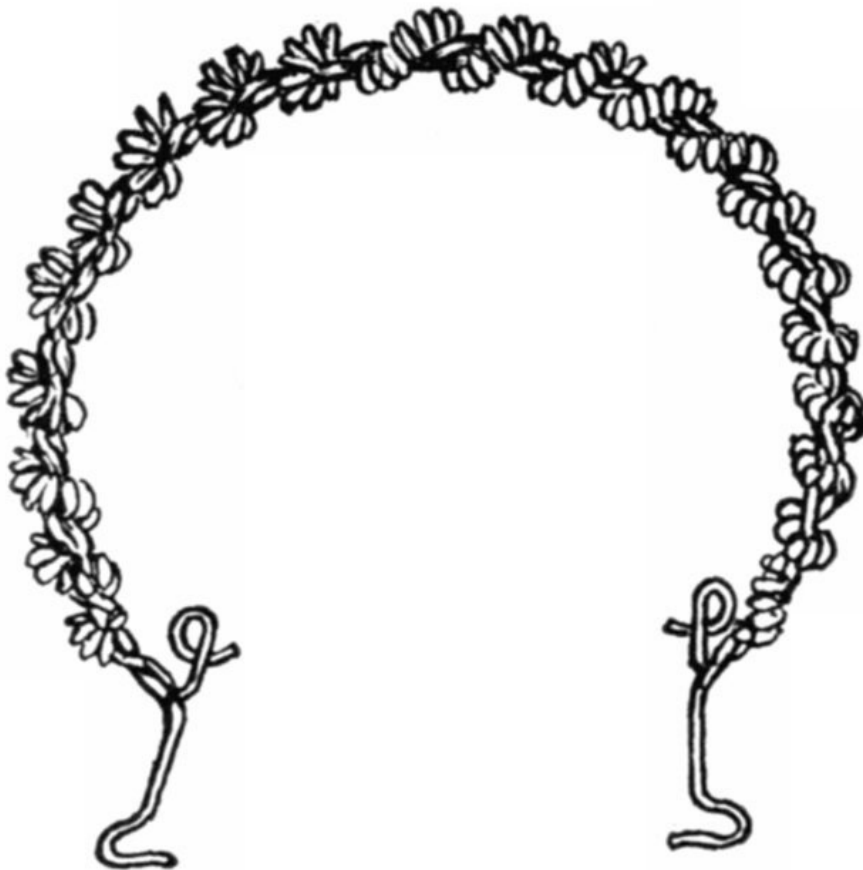

No. 1.

1.

Dozen.

As cut. Double twist,
with spiral
ornamentation; tinned; \$ 0 80
1 dozen in package



No. 2.

2.

Dozen.

As cut. Double twist; with spiral ornamentation; footed, \$ 1 20 tinned; 1 dozen in package



No. 3.

Dozen.

3.

As cut. Similar to No. 2, but close spiral work, presenting an attractive honey-comb effect; tinned; 1 dozen in package \$ 1 60

WIRE EASELS.

Cup and Saucer Easels.

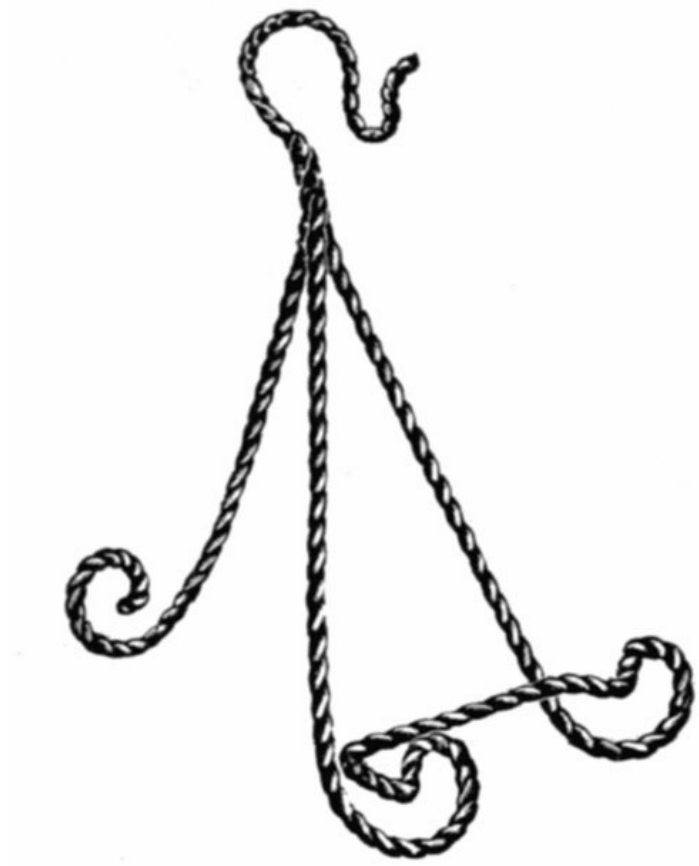

No. 148.

138.

70.

72/

Dozen.

Double twisted, tinned	\$ 0 80
Square single twist, brass	1 50
" " " larger, and is fancy brass trimmed	2 40

Plate Easels.

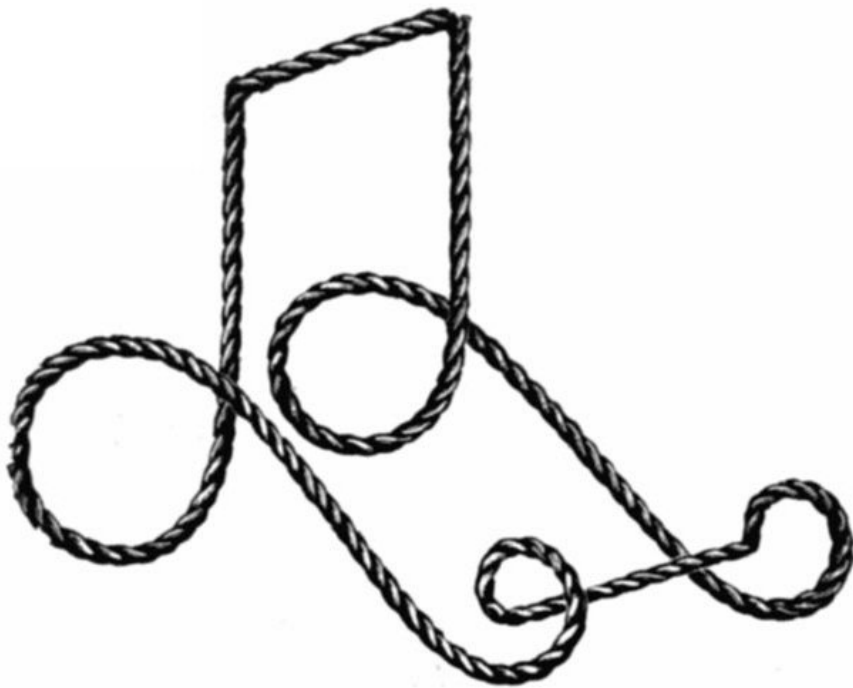

No. 111.

111.

Dozen.

Double twisted, tinned \$0 80

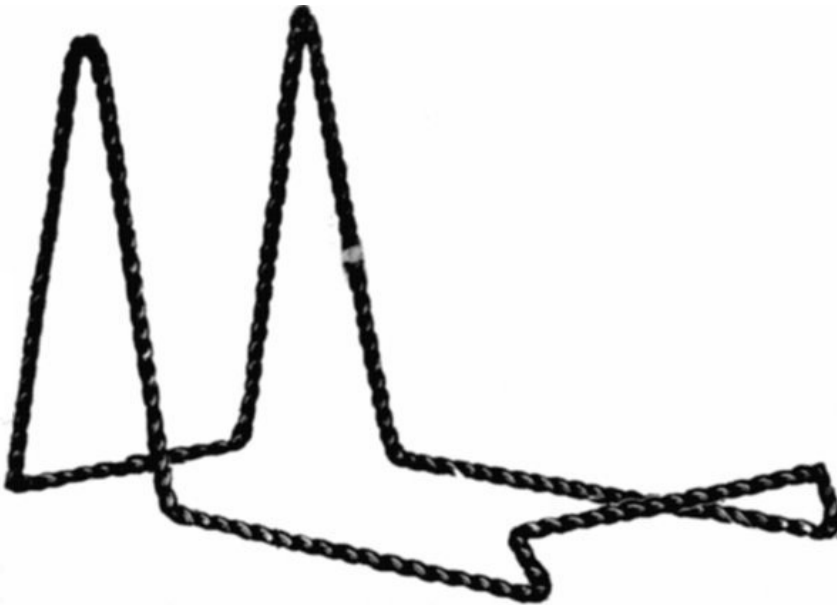

No. 101.

101.

202.

1508.

Dozen.

Double twisted, tinned \$0 80

Square single twist, brass 1 80

" " " " 2 40

Card Easels.

75.

76.

Square single twist, brass, leaf ornaments \$1 50

As 75, but larger 2 40

CHRISTMAS TREE CANDLES.

Gable Pattern. Assorted Colors in Fancy Boxes.

Per Pound.

100's.

80's.

60's.

48's.

30's.

100 to pound, ½ lb. in box \$0 50

80 " ½ " " 50

60 " ½ " " 50

48 " ½ " " 50

30 " ½ " " 50

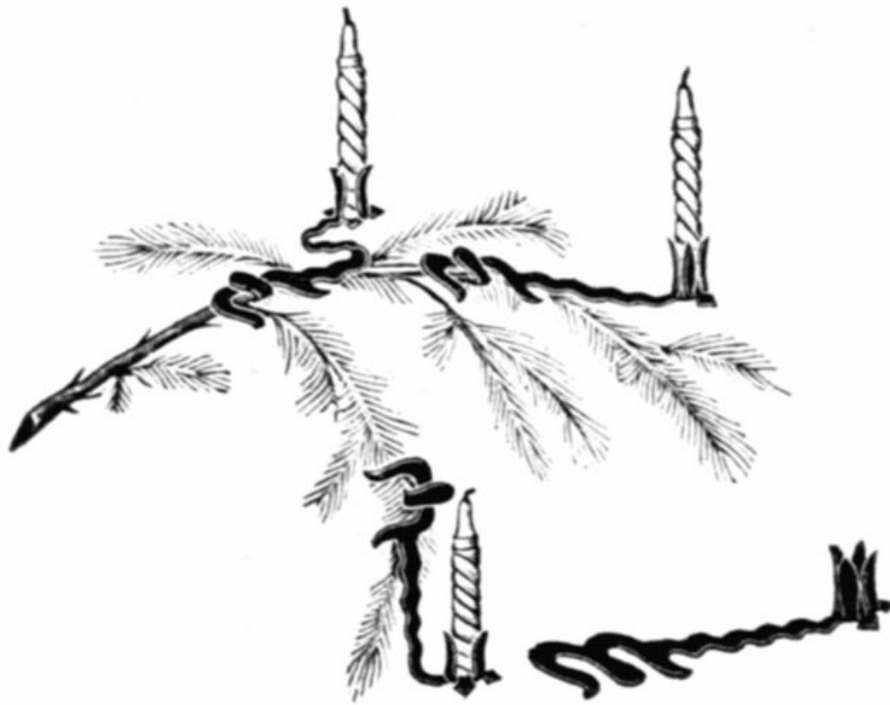

Extension Candle Holder, \$2 00 gross.

Paraffine Candles.

Per Box.

Twelves.	72 candles in box	\$ 1 70
Sixteens.	Best quality, 72 candles in box	1 80

Christmas Tree Ornaments.

Silver Tinsel,	\$6.00, \$8.40 and \$14.40 per gross yards (list.)
Assorted Colored Tinsel, (Tinsel is packed ¼ gross yards in box.)	\$8 40 per gross (list.)
String Garlands	in assorted fancy colors at 6c., 10c. and 12c. per string; (10 strings in box.) 30c., 40c., 50c., 60c., 70c., 80c., \$1.00, \$1.20, \$1.50 and \$1.60 per dozen (list.)
Glass Ornaments, (Above 1 dozen assorted in box.)	

Rotary-scope Lantern.

For Christmas Trees.

A great novelty. Consists of a fancy painted tin frame, oil lantern, with muslin panels in different colors. Inside is a fire proof cylinder, which revolves freely with the hot air from the burner, and as it goes round it casts on the muslin panels a variety of comical figures.

	Dozen.	
7.	Square shape, 7 inches high	\$ 4 00
8.	Hexagon shape, 10½ inches high	8 00

FOOTBALLS.

All are Regulation shapes, and are strictly First Class Stock and Workmanship.



- 3A.
- 4A.
- 5A. Glasgow,
- 5A. Varsity
- 5A.
- 6A.

Each.

Match, Assoc'n. cir. 22 in.	\$ 2 80
" " " 24 in.	3 60
match, assoc'n. cir. 26 in.	3 00
" " " 26 in.	3 00
" " " " 27 in.	4 10
" " " " 30 in.	4 80

Rugby.

- 5R.

Regulation Rugby, complete with bladder each,	\$ 4 10
---	---------

Football Bladders.

- 3.
- 4.
- 5.
- 5R.
- 6.

Dozen.

Best quality for No. 3A ball	\$ 9 00
" " " 4A "	12 00
" " " 5A "	13 50
" " " Rugby	13 50
" " " 6A	16 80



Ask for our Prices on Boxing Gloves and Striking Bags.

FLAGS.



Printed Cotton.

Far superior in appearance and durability to Printed Muslin. Note our prices. Write for sample.

UNION JACKS, Printed Cotton.

20
21
22
23
24
25
25½
26
27

Gross.

1½ × 3 inches, Unmounted	\$0 60
2 × 3 " "	80
2¼ × 4 " On Sticks	1 20
4 × 6 " "	1 80
4½ × 7½ " "	2 40
6 × 9½ " "	3 80
7 × 10½ " "	4 80
8 × 14½ " "	7 20
12 × 18½ " "	11 50

27½

12 x 23 " "

15 60

CANADIAN, Printed Cotton.

20

1½ x 3 inches,
Unmounted

\$0 60

21

2 x 3 " "

80

22

2½ x 4 " " On Sticks

1 20

23

4 x 6 " "

1 80

24

4½ x 7½ " "

2 40

25

6 x 9½ " "

3 80

25½

7 x 10½ " "

4 80

26

8 x 14½ " "

7 20

27

12 x 18½ " "

11 50

27½

12 x 23 " "

15 60

Printed Cotton, Hemmed and Stitched. Not on Sticks.

Union Jacks

" "

" "

" "

" "

Red Ensign

" "

" "

" "

Canadian

"

"

Royal Standard

" "

Stars and Stripes

Dozen.

Size, 15 x 10 inches

\$0 80

" 17 x 15 "

1 30

" 30 x 17 "

2 40

" 25 x 21 "

2 00

" 35 x 24 "

3 10

" 30 x 17 "

2 40

" 35 x 24 "

3 10

" 60 x 30 "

12 00

" 70 x 40 "

16 00

" 15 x 10 "

80

" 30 x 17 "

2 40

" 35 x 22 "

3 10

" 15 x 10 "

80

" 25 x 22 "

2 00

" 30 x 19 "

2 40

36 inches in
length at 50cts.
dozen.

48 inches in
length at 60cts.
dozen.

FLAG STICKS

PAPER MASKS.



87/2.

Gross.

Assorted, ½ gross in
package

\$1 80

87/3.

Assorted with
moustaches, ½ gross in
pkg.

2 00

87/5R.

" " " ¼ " "

6 00

Negroes, assorted, 1-

87/7N.	12 gross in pkg.	7 20
87/7.	Assorted with moustaches, ¼ gross in pkg.	7 20
141/3.	Assorted, ¼ gross in package	9 60
Dozen.		
87/13.	Assorted, finely waxed, 2 dozen in pkg.	1 50
87/13N.	Negroes, finely waxed, 2 doz. in pkg.	1 50
87/19.	Assorted Clowns, 1 dozen in package	2 00
84/21.	Assorted, with whiskers, 2 doz. in pkg.	2 00
87/53.	Assorted Animals, ½ dozen in package	2 40
141/4.	Extra fine, waxed assorted men and women, 1 dozen in package	3 60

Santa Claus Masks.



With long beard, \$2.40, \$3.60 and \$4.80 dozen.
With long beard and hood, \$6.00 dozen.

Linen Gauze Masks.

87/58.	Dozen. Ladies and Gents, 3 dozen in package	\$1 50
87/58C.	Assorted characters, 3 dozen in pkg.	1 50
141/5.	Assorted comic, 1 dozen in package	1 60

Wire Gauze Masks.

141/1.	Dozen. Ladies and Gents	\$2 40
--------	-----------------------------------	--------

Domino Masks.



201. Cotton,
6. Silk,

Dozen.

assorted colors
assorted colors

\$ 0 60
4 00

THERMOMETERS.

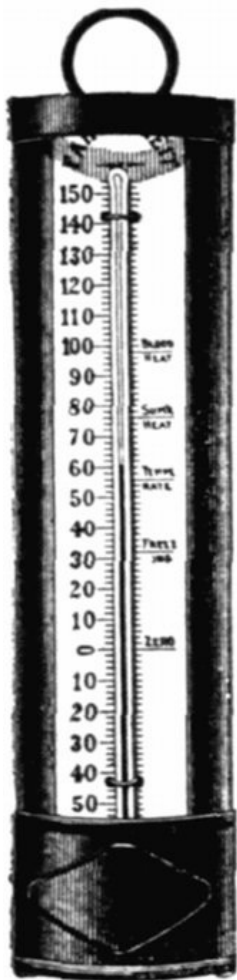

7 and 8 inch Jap'd.

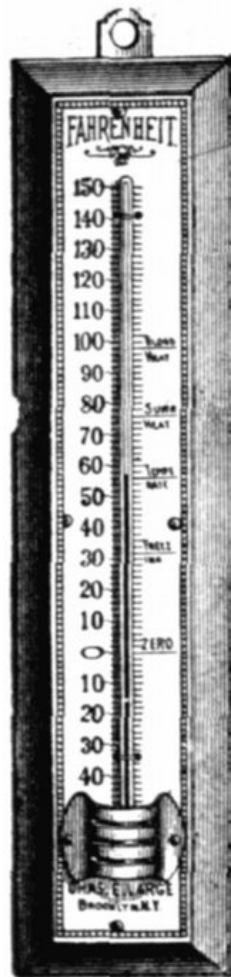

"Panel."



"Floating Dairy."

373/22.

34 18.

34/20.

7-inch.

8-inch.

599 21.

694.

"Panel."

262/26.

766/18.

E. R.

893/20.

893/25.

X Floating Dairy,

O X X " "

430/15. Excelsior Barometer,

Dozen.

Wood back, paper scale, 8¾ inches	\$ 0 80
Natural polished wood back and scale, 7-inch	1 60
Black enamelled wood back and scale, 8-inch	2 20
Japanned tin case	2 20
" "	2 50
Painted wood back, 8 inches	2 50
Wood back, sick room thermometer	3 20
Wood back, tin scale, 8½ inch	3 80
Painted wood back, 10 inch	4 00
Wood back, opal glass front, large black scale 6½ inches	4 00
Wood back, tin scale, extra large scale, 10 inches	4 80
Wood back, opal glass front, extra large scale, 8 inches	8 00
As 893/20, but 10-inch all glass	12 00
extra large	1 50
black enamelled back, 6-inch	4 00
	3 00

Reading Glasses.



4189.

4190.

4191.

Dozen.

Enamelled frame, 2-inch lens, wood handle, each in fancy box	\$12 00
Enamelled frame, 2½-inch lens, wood handle, each in fancy box	16 00
Enamelled frame, 2½-inch lens, wood handle, each in fancy box	20 40

POCKET COMPASSES.

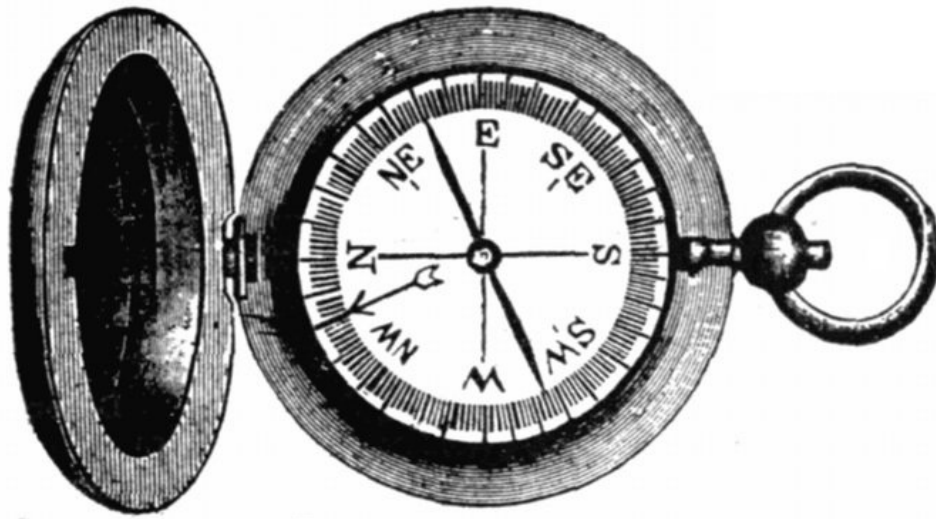

No. 4198.

- 14/167.
- 4198.
- 4687.
- 14/463.
- 4712.
- 4743.

Dozen.

Nickel, open face	\$ 3 20
" closed face	10 80
" open face, with stop attachment	9 60
" closed " " "	14 40
" marine compass with lid	6 00
" " " "	7 50

Magnifying Glasses.

- 3745.
- 393/5.

Small size, nickel frame and handle, 7/8-inch lens; 1 dozen on card	\$ 2 40
Tortoise shell, celluloid frame and handle, folding; 1 1/2-inch lens	3 00

Microscopes.

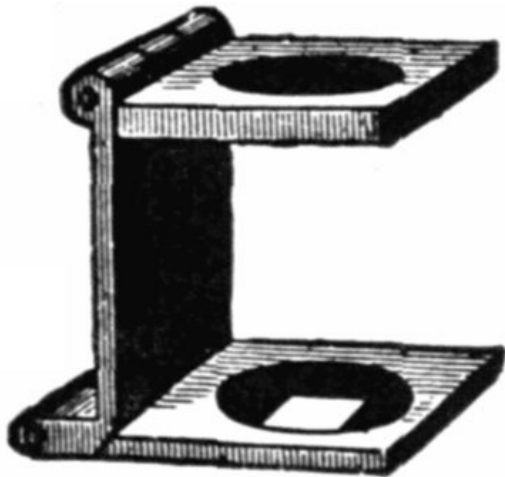

No. 1733.



No. 1332.

<p>1733.</p> <p>1738.</p> <p>1332.</p> <p>1735.</p>	<p>Dozen.</p> <p>Folding Linen Tester, brass \$ 4 00</p> <p>Cylinder shape, for liquids and solids 4 00</p> <p>Tripod, double lens 7 00</p> <p>On stand, with reflector and perfect adjustment, each in polished wooden case 36 00</p>
---	---

Coddington Glasses.

For use of Prospectors, have Double Lenses and are very powerful.

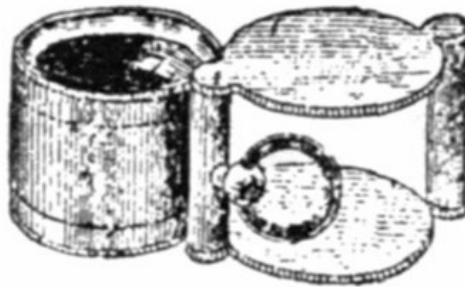

No. 20.

<p>20.</p> <p>25.</p> <p>30.</p> <p>2.</p> <p>3.</p> <p>4.</p>	<p>Dozen.</p> <p>Nickel, folding packet case with ring, as cut, $\frac{3}{4}$-inch lens \$21 00</p> <p>As 20, but $\frac{7}{8}$-inch lens 24 00</p> <p>As 20, but $1\frac{1}{8}$-inch lens 28 00</p> <p>Nickel frame and handle, $\frac{7}{8}$-inch lens 18 00</p> <p>Brass frame, black enamelled handle, $1\frac{1}{8}$-inch lens 24 00</p> <p>As 3, but $1\frac{3}{8}$-inch lens 28 80</p>
--	--

COMBS.

All Combs are packed one dozen in a box.

Horn Dressing Combs.



5-inch.

0-6½.

146-6-inch.

0-7.

120.

120.

120.

120.

120½.

120½.

120½.

Dozen.

"Crambo," all coarse teeth, extra thick straight square back	\$0 80
Extra value, 6½-inch comb, straight square back	84
Fine and coarse teeth, straight square back, 6 inches long	90
Same as 0-6½, but 7 inches long	90
6-inch, slightly arched square back	90
6½ inch, " "	1 00
7-inch, " "	1 10
7½-inch, " "	1 30
6½-inch, double thick, slightly arched square back	1 10
7-inch, double thick, slightly arched square back	1 30
7½ inch, double thick, slightly arched square back	2 00

Aluminum Back Horn Combs.



Panther.

070.

3975.

Dozen.

6½-inch, Dressing, coarse and fine	\$2 80
6½-inch, " "	3 00
7½ inch, " "	3 50

Barber's Combs.



71/6.

71/7.

333/7.

1130.

6-inch, Plain horn	\$0 90
7-inch, "	1 20
7-inch, Vulcanite	1 30
7-inch, " extra thin	2 20

Pocket Combs.



99/4.

147/4.

853/4.

868.

150¾.

195.

198.

830.

833.

4-inch, Horn, in case	\$0 70
4-inch, Vulcanite, in case	90
4 inch, " "Hanover" in case	1 50
Vulcanite, folding	1 60
4½-inch, Vulcanite, in case	1 80
4½-inch, " "	2 20
Vulcanite, in case	2 40
Twin-folding, Vulcanite	3 00
" "	4 00

Vulcanite Dressing Combs.

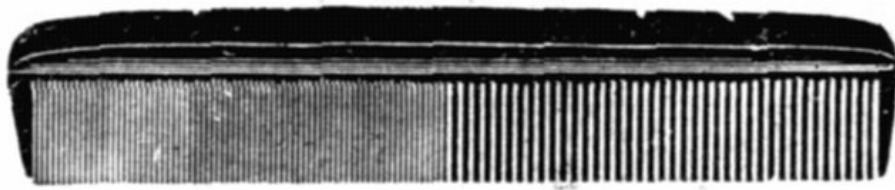

- 0-1855.
- 302.
- 309.
- 972¾.
- 307.
- 309.
- 07.
- 957.
- 309.
- 309.
- 277G.
- 256.
- 261.
- 329.
- 329.

Dozen.

7-inch, "Bulldog" straight back	\$1 00
7-inch, arched concave back	1 00
6½-inch, straight square back	1 60
7-inch, " "	1 50
7-inch, crook oval back	1 60
7-inch, straight back	1 80
8-inch, crook oval back	2 00
7½-inch, concave back, stamped "The Favorite"	2 00
7½-inch, straight square back	2 30
8-inch, straight square back, stamped "Unbreakable"	2 50
8-inch, straight back	2 50
7½-inch, straight square back, stamped "Unbreakable"	3 50
8-inch, straight concave back, guaranteed positively unbreakable with fair use	4 00
8-inch, "Unbreakable," straight oval back	5 20
9-inch, as above	6 50

Celluloid Dressing Combs.



- 353/18.
- 353/30.
- 353/12.
- 353/21.
- 353/31.
- 353/29.

Dozen.

6-inch, White finish	\$1 40
6½ inch, Tortoise-shell finish	1 80
7-inch, " "	2 40
6½-inch, Imitation Ivory	2 50
7½-inch, Tortoise-shell finish	2 50
7-inch, " " very fine	4 00

Metal Back Horn Combs.

- 21.
- 21.

Dozen.

6 inch, extra strong straight metal back	\$1 50
7-inch, " " " "	1 60

Aluminum.



No. 446.

Made of Solid Aluminum, very strong and serviceable.

540.

435.

315x.

446.

449.

Dozen.

4 inch, in Pocket case	\$0 70
4¾-inch, "	1 00
6-inch, Folding Pocket	3 60
7 inch, Dressing, narrow	2 20
7¾-inch, " wide	2 70

Fine Combs.

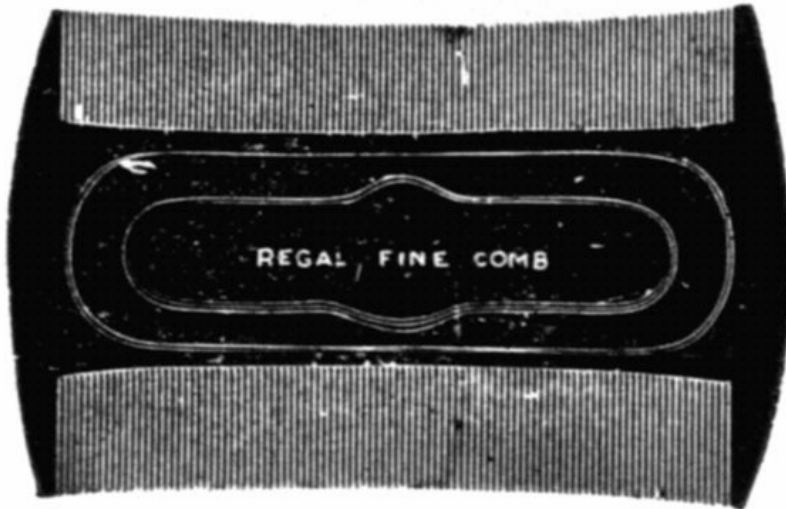

2¾

3¾

14.

P.H.

350/12.

350/13.

596.

352/15.

725.

353/24.

353/26.

353/27.

353/28.

353/34.

372/13ss.

372/15ss.

71G/4.

46B/41.

055V/3¾.

Dozen.

-inch, Horn, plain	\$ 0 60
-inch, " "	70
2½-inch, " extra quality	1 10
4-inch, " " one side coarse	1 30
3-inch, Vulcanite, plain	80
3¼-inch, " "	84
3-inch, " fine quality	1 40
3¾-inch, " super quality	1 50
3-inch, " very fine	1 50
3-inch, White Celluloid	70
3½-inch, " "	1 20
3¾-inch, Fine White Celluloid	1 40
3½-inch, Fine White Celluloid, extra quality	1 60
3¼-inch, Tortoise shell Celluloid	1 20
3¼-inch, "Bull Dog" Vulcanite	1 30
3¾-inch, "Bull Dog" Vulcanite	1 50
4-inch "Giant" Vulcanite	1 60
4-inch, "Unbreakable" Vulcanite	1 80
3¾-inch, "Triumph," unbreakable vulcanite	3 00

Round Combs.

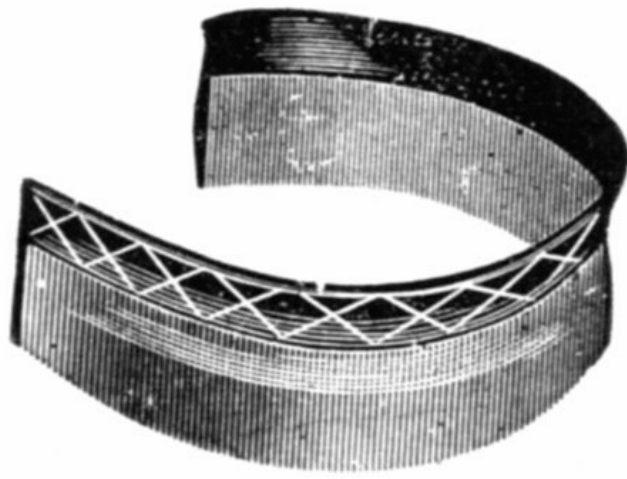

425.
192.
141.
152.

Dozen.

Rubber, plain edge	\$ 0 80
" open "	1 30
" fancy "	1 70
" " "	2 40

Side Combs.



Side combs in large variety, ranging in price from 80c. to \$6 00 dozen (list).

Curling Tongs.

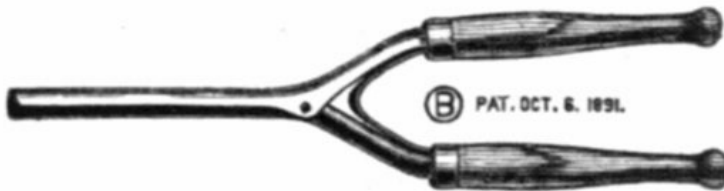

1240.

C.

"Victor."

"B."

Dozen.

Straight shape, polished steel, black enamelled handle; a leader at the price	\$ 0 40
Straight shape, scissors style, small size Mustache curler	60
Straight shape, nicked steel, natural wood polished handle, extra strong, durable spring	70
Scissors style, nicked steel, natural wood handles, extra value	70

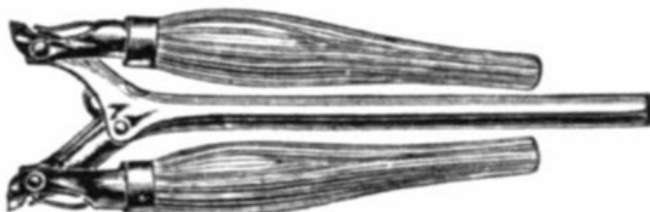

TOURIST. PAT. MAY 8. 94.

"Tourist."

Patent folding curler,
nickel steel, fine
polished steel handles 2 00



"Paragon."

Patent end-spring
curler, nickel steel,
polished wood handles 2 20

Wire Hair Curlers.

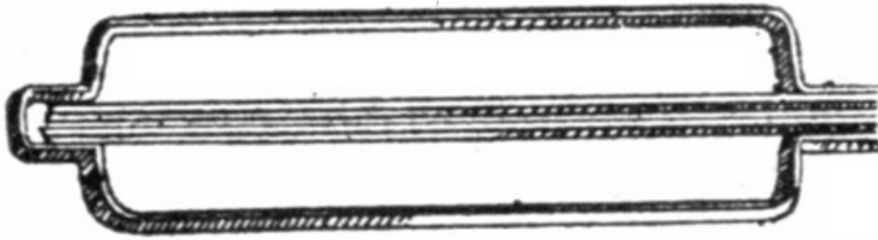

No. 176.

61/175.

Gross.
Crimped, 2½-inch, 1
dozen in box \$ 0 80

61/177.

Straight, 3½-inch, 1
dozen in box 1 70

61/176.

Per 100.
Straight, 2½-inch, 100
in box \$ 1 00

Kid Hair Curlers.



1792/10.

Gross.
1 dozen in bunch, 2¾-
inches long \$ 0 80

2344.

1 " " 4 " " 90

2345.

1 " " 4¼ " " 1 00

2346.

1 " " 4¾ " " 1 20

1792/411.

1 " " 5¼ " " 1 50

Glove Stretcher.

637.

Scissor style, polished
whitewood \$2 40

SAFETY PINS.



2.

Gross.
"Lindsay" best quality,
1⅞ inches long \$0 40

2½.

" " " 1½ " 50

3.

" " " 1¾ " 60

6.
8.
10.

Dozen.

" " " 2¾ "	60
Blanket Pin	70
" " larger	80

Hair Pins.

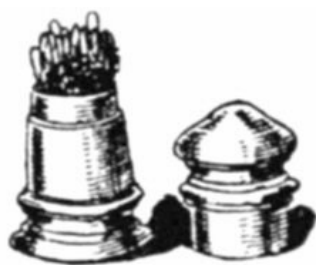

15.

Blued,
"

Black,
"

Per 1000.

Invisible, 1⅛ inch, crimped	\$0 50
2¼ inch, straight	80
¾ "	96
2½ inch, crimped	72
¾ "	80

Gross Packages.

27.

30.

33.

Black, ball pointed, 2½ inch, crimped	4 80
" " " 2¾ " "	4 80
" " " 3 " "	4 80

Saxon Cabinet,

polished wood, round shape, filled with assortment of black enamelled gross cabinets,	9 60
---	------

Armlets.

1000.

200.

Gross Pairs.

Spiral wire, bright finish	\$6 00
" " cotton covered	8 40

Ventilated Garters.

Double spiral Garters or Armlets, bright wire and metal socket fastening

Dozen Pairs.

\$2 00

Brushes.

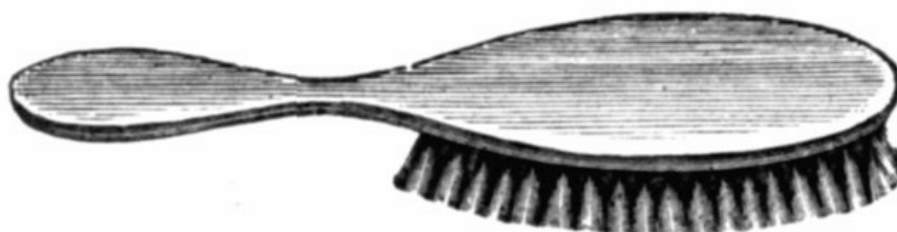

We carry a very large range of Hair brushes in all styles, to retail at from 25c. to \$1.25 each.

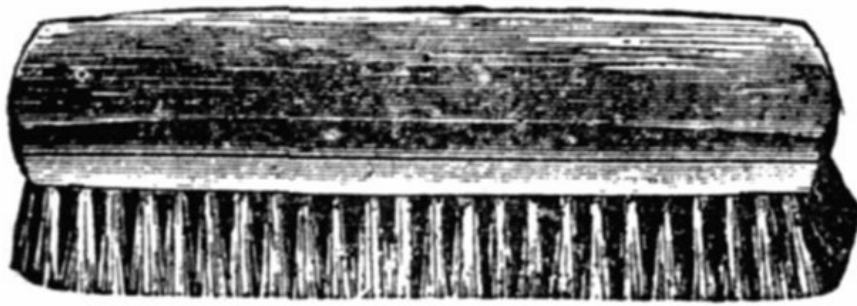

Cloth Brushes to retail from 25c. to 75c.
 Also carry: Hat brushes, whisks, military brushes, nail brushes and a very large variety of tooth brushes.

LATHER BRUSHES.

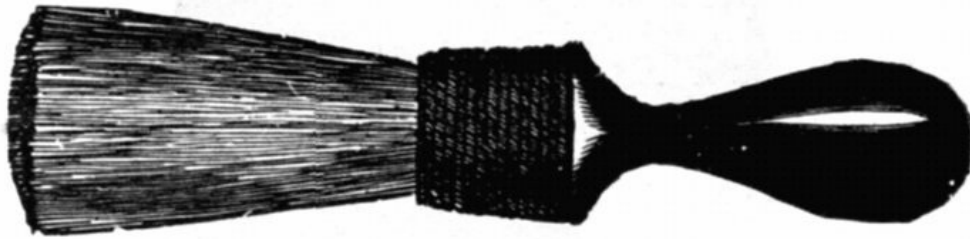

	Dozen.	
372/1.		Small size, black enamelled handle \$0 60
372/2.		Medium size, black handle 70
27.		Back enamelled handle 80
1B.		Natural wood handle, black enamelled ferrule 1 60
865.		Natural wood handle, black ferrule, oval cut 2 00
701.		Drip brush, enamelled handle and drip cup 2 40
136.		Enamelled handle, string wound 2 40
876.		Natural wood handle, nickel ferrule, oval cut 3 00
1501.		Ebony handle, oval cut badger 3 50
106.		Enamelled handle, wire wound, square cut 3 50
Pilot.		Enamelled handle, wire wound, square cut 3 70
404.		Polished wood handle, horn ferrule 7 50
710.		Bone handle, oval cut badger 9 00

Shaving Brush Assortments.

Comet	assortment, 1 dozen in display box	\$0 80
Favorite	" 1 " " "	1 20
Premier	" 1 " " "	1 60
Crown	" 1 " " "	3 00

Razor Strops.

5.	Damascus combination belt strop, 2 sides, adjustable handle	\$4 00
Crescent	combination belt strop, 2 sides, adjustable handle	5 50
88.	Howard cushion combination, 4 sides extra quality, stock	12 00

throughout

SWING STROPS.

101.	Leather and canvas on pivot, leather handle	\$2 50
102.	As above, wood handle	3 20
300.	Calf and canvas, on pivot, wood handle	3 60
1100.	Porpoise hide, padded leather handle	8 00
10.	Double leather, one side fine horsehide, nickel clamp and screw so that strops can be removed and replaced, extra quality	9 60

Shawl Straps.

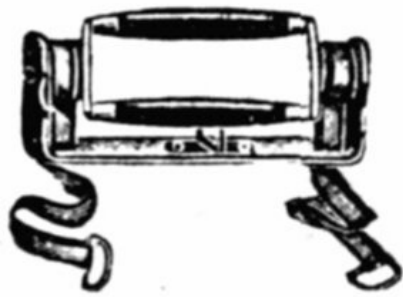

Royal.



No. 1.

122.	Nickel handle, 36 inch straps	\$4 20
1.	Stiff leather handle, 45 inch straps	2 50
2.	Stiff leather handle, larger	4 00
33.	Stiff leather handle, extra quality, 42 inch straps	6 00
Royal	web strap, swivel handle	2 50

HAND MIRRORS.



No. 237/180.



No. 237/181.

237/180.

237/181.

237/56.

237/182.

237/183.

Dozen.

as cut. Oval shape, bevel, imitation ebony back. Size, $10\frac{1}{2} \times 4\frac{1}{4}$ inches; 1 dozen in box \$3 60

as cut. Oblong shape, bevel, imitation ebony back. Size, 10×4 inches; $\frac{1}{2}$ dozen in box 4 00

as 237/181 but larger. Size, $11\frac{1}{2} \times 4\frac{3}{4}$ inches; $\frac{1}{2}$ dozen in box 5 50

Extra thick bevel, oblong mirror, one piece imitation ebony back. Glass is put into this mirror by the new heat expansion process, and not work loose. Size, $11 \times 4\frac{1}{2}$ inches; each in box as 237/182 but size, $11\frac{3}{4} \times 4\frac{3}{4}$ inches; each in box 16 00



No. 237/330.

237/329.

237/330.

237/331.

237/332.

Dozen.

Same shape as cut
237/330. Round bevel
mirror, imitation ebony \$4 00
back. Size, 8 × 4
inches; 1 dozen in box
as cut. Heavy bevel
mirror, one piece
imitation ebony back.
Glass is put in by new
heat expansion process 13 00
and will not work
loose. Size, 8½ × 4½
inches; each in a box
as 237/330 but size, 16 00
9¼ × 5 inches; each in
a box
as 237/330, but size,
10¼ × 5¼ inches; each 19 20
in a box

EASEL BACK MIRRORS.



No. 0218.

	Dozen.
0218.	Oblong shape bevel mirror, imitation ebony back. Size, 6½ × 4½ inches. Heavy wire easel handle; each in box \$13 00
0219.	as 0218, but size, 7½ × 5½ inches; each in box 17 00
237/184.	Same style as above, but round shape, bevel mirror, imitation ebony back, easel handle. Diameter, 5½ inches; each in a box 9 60
237/185.	as 237/184, but diameter 6½ inches; each in a box 13 00
237/315.	Oblong shape. Size, 5½ × 3¾ inches; natural finished wood back, easel handle; 1 dozen in package 1 70
237/317.	Oblong shape, bevel edge, fancy flowered, natural finished wood back, easel handle. Size, 7 × 4¾ inches 3 70
237/318.	Diamond shape, fancy flowered bevel mirror, natural finished wood back, easel handle. Height, 7½ inches 3 20
237/319.	Horseshoe shape, fancy flowered, bevel mirror, natural finished wood back, easel handle. Height, 7½ in. 4 50
237/322.	Oblong shape, heavy bevel plate, fancy flowered, polished wood back, easel handle. Height, 6¾ inches; each in a box 8 40
237/324.	as 237/322 but larger. Height, 8½ inches; each in a box 16 80
	Diamond shape, heavy bevel plate, fancy beaded edge and colored flowers,

237/128.

polished wood back, 8 40
easel handle. Height,
7½ inches; each in a
box

237/130.

as 237/128 but larger. 16 50
Height, 11 inches;
each in a box

HARMONICAS.



No. 249/2.

352/1.

Gross.
"The Wagner," 10
single holes, single
reeds, large circle back
cover \$8 40

249/2.

"Richter," 10 single
holes, double reeds, 9 60
nickel covers

427½.

"The Perfection," 10
single holes, single
reeds, nickel covers 10 00

249/4.

"The Boss Richter," 10
single holes, double
reeds, nickel covers 15 60

249/5.

"Our new Corker" 18 00

534.

Dozen.
"The Columbus," 10
single holes, double
reeds, oval nickel case 1 50

352/3.

"Military Band Harp,"
10 single holes, double
steel bronze reeds,
smooth curved nickel
cover 1 60

352/8.

"The P. S. Gilmour," 10
single holes, double
reeds, **celluloid cover** 1 60

249/8.

"Richter," 10 single
holes, double reeds,
nickel covers 1 60

352/11.

"Lilliputian," very small
size, 10 single holes,
double reeds, curved
nickel cover 1 60

249/6.

"The Champion," 10
single holes, double
reeds, nickel cover,
large size 1 80

873.

"The Little Gem," 10
single holes, single
reeds, nickel cover,
good quality 2 40

249/7.

"The Gilmore," 10
single holes, double
reeds, heavy nickel
arched sliding cover 2 50

249/9.

"Olympia," 16 double
holes, curved cover 3 00

214.

"The Midget," 10
single holes, single
reeds, nickel cover 3 50

352/13.

"Bohm's Harp," 10
single holes, double
reeds, in trunk style,
hinge cover case 3 60

239.

"The Little Pearl," 10 single holes, single reeds, solid piece nickel, covers, sides and top 3 70

202.

"Silver Orchestra," 10 single holes, new shape, curved open back cover 3 80

201.

"Silver Orchestra" 10 double holes, concert size, new curved open back cover 8 00



No. 182/1.

Dozen.

182/1.

Crescent Shape (as cut), 10 single holes, curved mouthpiece affords considerable accommodation to players \$4 00



Dozen.

910.

"Doerfel's International," 10 double holes, sliding celluloid cover as in above cut \$8 00

71.

"David's Harp," 10 single holes celluloid cover, assorted white, black and tortoise shell 4 50



No. 50B.

Dozen.

214.

Hohner's Lilliputian, small size, 10 single holes, double reeds, curved nickel cover \$3 40

50B.

" 10 double holes, nickel covers 3 50

34B.

" 10 single holes, nickel covers 3 50

1896/20."

" "Marine Band," 10 single holes, improved curved nickel 4 00

	cover, open back	
	" "Grand	
842.	Symphony," 10 single holes, each in trunk style case	4 00
	" "Marine Band,"	
1897/20.	same as 1896/20, in trunk case, plush lined	5 40
	" "Up-to-Date," 10	
1896½/20."	double holes, in trunk case	6 70
	" "Marine Band,"	
1896/40."	10 double holes, smooth curved cover, open back	9 40
	" "Chromatically Tuned," a simple but perfectly arranged instrument for playing all kinds of music where half notes are required, made in concert size with nickel open back covers. In plush-lined, trunk style cases	19 20

CLOVER HARMONICAS.



No. 130.

130.

140.

Dozen.

New "Clover," as cut, 10 holes, 20 reeds. One piece solid brass covers \$3 60
 New "Clover," as above, but double reed, concert size 7 20

NEW TRUMPET HARMONICAS.

Have brass reed trumpets that add greatly to strength and sweetness of tone.



No. 251.

Dozen.

Koch's "Trumpet Organ," as cut, 10

251.	single holes, 20 reeds, nickel covers, brass reed trumpets	\$4 00
467.	Messner's "David's Harp," same as Koch's "Trumpet Organ," 10 double	251 4
252.	holes, 20 reeds, nickel covers, brass reed trumpets	00
460.	Messner's "David's Harp," same as	252 6
465.	" " " as above, but double reed, "concert" organ	00
		8 40

SYMPHONIIONS.

We are Canadian agents for **Imperial Symphonions**.



Illustrated price list mailed on application.

ACCORDIONS.

We carry a full line of **Imperial** and **Empress** Accordions.

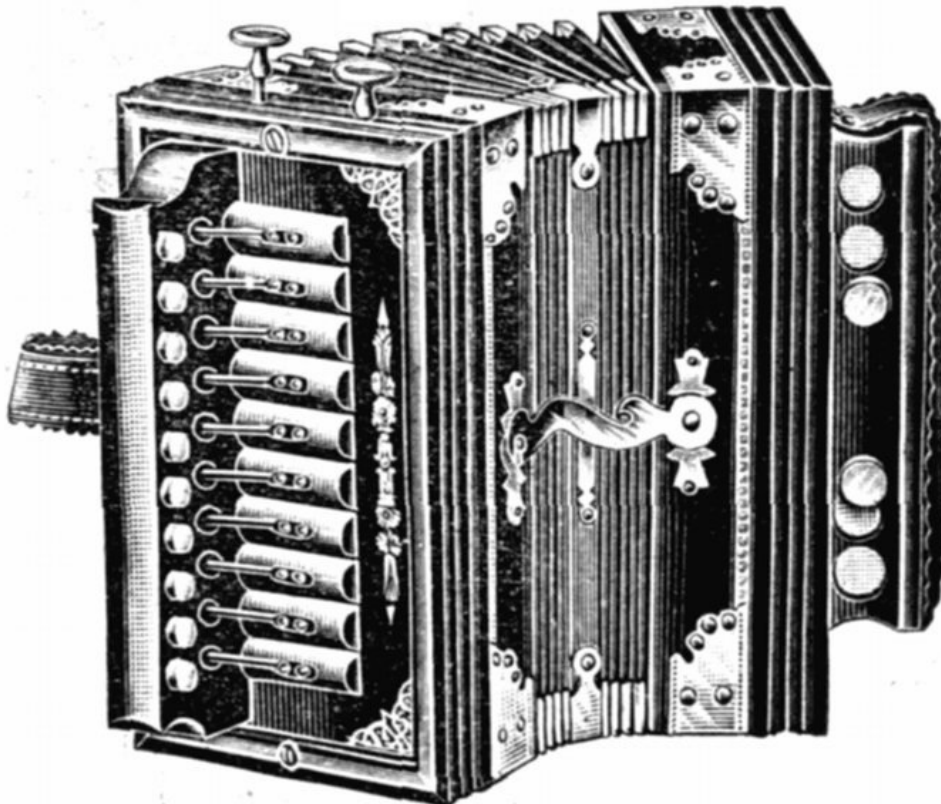

Illustrated price list mailed on application.

VIOLINS.

AND VIOLIN SUNDRIES.



Illustrated price list mailed on application.

SPECIALS IN PIPES.

To Retail at 15, 20, 25 and 30 Cents.



Order a sample line of N. & C. Pipes.

CASE PIPES.

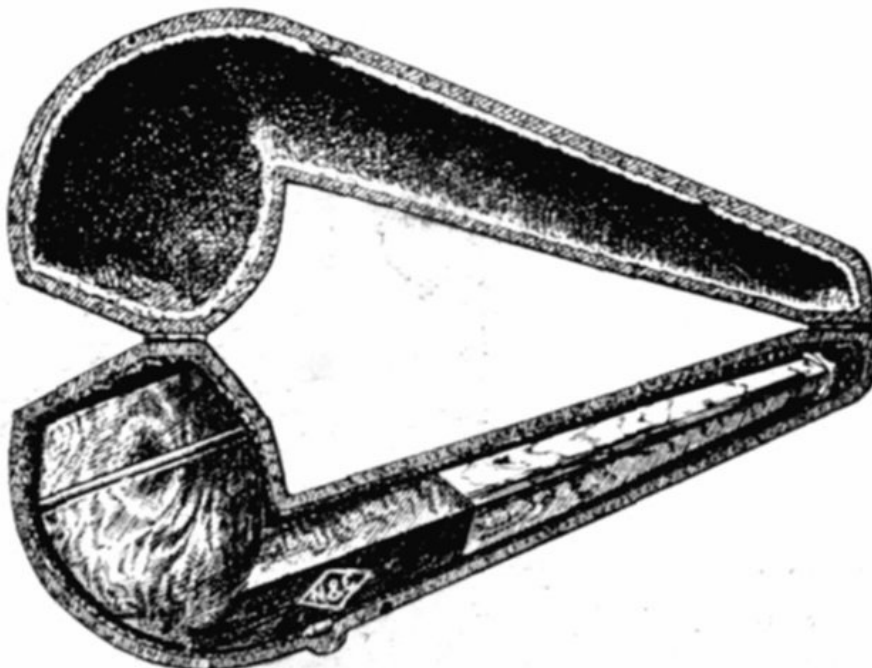

Case and Presentation Pipes in all styles, and at all prices.



INDEX.

A

A B C Blocks, [62](#)

A B C Dolls, [86](#)

Accordeons, [114](#)

Air Pistols, [81](#)

Air Rifles, [81](#)

Arks, [85](#)

Armlets, [110](#)

Albums, [3](#)

Attachments, [57](#)

B

Baby Sleighs, [29](#)

Baby Swings, [36](#)

Baby Baskets, [33](#)

Ball Toss, [43](#)

Banks, Iron, [55](#)

" Tin, [55](#)

Bath Tubs, Toy, [77](#)

Baskets, Office, [33](#)

Baskets, Baby, [33](#)

Bells, [85](#)

Bell Chimes, [38](#)

Bellow Toys, [84](#)

Berry Sets, China, [97](#)

Bisque Babies, [86](#)

Black Boards, [40](#)

Blocks, all kinds, [62](#), [63](#)

Boat Arks, [85](#)

Boa's, Steam, [56](#)

Books, Toy, [67](#), [68](#)

Books, Half-bound, [69](#)

Brushes, all kinds, [110](#)

Brush Sets, [7](#)

C

Cake Plates, China, [97](#)

Cap Pistols, [81](#)
Carts, Toy, [32](#)
Calliope Whistle, [72](#)
Card Games, [66](#)
Carpet Balls, [43](#)
Carroms, [42](#)
Cannons, Pea, [73](#)
Celluloid Boxes, [4](#), [11](#)
Checker Boards, [64](#)
Checker Men, [64](#)
Chess Men, [64](#)
China Babies, [86](#)
Children's Mugs, [95](#)
China Limb Dolls, [86](#)
Chinaware, all kinds, [92](#), [98](#)
Christmas Ornaments, [105](#)
Clapping Toys, [84](#)
Coddington Glasses, [107](#)
Collar and Cuff Boxes, [11](#)
Combs, all kinds, [108](#)
Comb, Brush and Mirror Sets, [8](#), [9](#)
Compasses, Pocket, [107](#)
Cows, Leather, [82](#)
Cow Horn Trumpets, [71](#)
Cradles, Doll, [22](#)
Crayons, [75](#)
Cream Jugs, China, [96](#)
Cribbage Boards, [64](#)
Crotchet Sets, [14](#)
Crokinole, [42](#)
Crowing Roasters, [83](#)
Cruisers, [25](#)
Cups and Saucers. China, [92](#), [94](#)
Cup, Saucer and Plate Sets, [95](#)
Curling Tongs, [109](#)

D

Dancing Bears, [83](#)
Dice, [64](#)
Dolls, all kinds, [86](#), [91](#)
Doll Chairs, [20](#), [23](#)

- " Heads, [91](#)
- " Hammock, [23](#)
- " Houses, [37](#)
- " Swings, [23](#)
- " Beds, [22](#)
- " Cradles, [22](#)
- " Go-carts, [35](#)
- " Cabs, [31](#)
- " Trunks, [36](#)
- " Baths, [77](#)
- " Wash Stands, [77](#)

Dog Whips, [73](#)

Dominoes, [65](#)

Domino Masks, [106](#)

Drawing Slates, [75](#)

Dressing Cases, [4](#), [7](#)

Dressed Dolls, [88](#)

Driving Reins, [85](#)

Drums, [20](#)

Dust Pans, [80](#)

E

Easels, Wire, [104](#)

Egg Cups, [98](#)

Electrical Toys, [57](#)

Engines, Mechanical, [78](#)

Engines, Steam, [56](#)

F

Fire Department, Iron, [52](#)

Fireside Games, [66](#)

Fish Horns, [71](#)

Flags, [106](#)

Floor Chimes, [38](#)

Flying Bird, [79](#)

Flute Whistles, [71](#)

Footballs, [105](#)

Fort, [43](#)

Frames, Photo, [12](#), [13](#)

Friction Boats, [80](#)

Fur Dogs, [82](#)

Fur Goats, [82](#)

Furniture, Wood, [21](#)

Furniture, Pewter, [44](#)

G

Games, [42](#), [64](#), [66](#)

Glasses, Stem, [103](#)

Glassware, [100](#)-103

Glove and Hdkfs., Celluloid, [10](#)

Go-carts Reed, [35](#)

Guns, Toy, [73](#)

H

Hair Curlers, [109](#)

Hair Pins, [110](#)

Hammers, [53](#)

Harmonicas, [112](#)

Hatchets, [53](#)

Hay Cart, [32](#)

Horns, Tin, [71](#)

Horses, [30](#), [31](#)

Hot Air Motors, [56](#)

Houses, Doll, [37](#)

I

Iron Banks, [55](#)

" Sad, [54](#)

" Fire Department, [52](#)

" Stoves, [54](#)

" Toys, [50](#), [53](#)

" Trains, [53](#)

J

Jackstones, [53](#)

Jardinieres, [17](#)

Jointed Dolls, [87](#)

K

Kaleidoscopes, [72](#)

Kid Dolls, [87](#)

Kinematographs, [61](#)

Kitchens, Toy, [37](#)

L

Lanterns, Magic, [58](#), [60](#)

Lantern Slides, [60](#)

Laughing Cameras, [72](#)

Laundry Sets, [24](#)

Leather Cows, [82](#)

Locomotives, [78](#)

Lunch Boxes, [33](#)

M

Magic Lanterns, [59](#)

Magnets, [85](#)

Magnifying Glasses, [107](#)

Manicure Sets, [16](#)

Masks, [106](#)

Mechanical Locomotives, [78](#)

Mechanical Toys, [79](#)

Microscopes, [107](#)

Mirrors, all kinds, [111](#)

Motors, Hot Air, [56](#)

" Electric, [57](#)

Mouth Organs, [112](#)

Monkey Toys, [84](#)

Moving Picture Machines, [61](#)

Musical Chimes, [38](#)

Music Boxes, Symphonion (special list).

Musical Tops, [70](#)

Mugs, Children's, [95](#)

Mugs, Shaving, [98](#)

N

Necktie Boxes, [10](#)

Noah's Arks, [85](#)

Novelty Tape, [14](#)

Nurse Dolls, [89](#)

O

Office Baskets, [33](#)

P

Palms, [18](#), [19](#)

Paint Boxes, [75](#)

Paper Pulp Soldiers, [44](#)

Papier Mache Horses, [31](#)
Parchessi, [66](#)
Pea Whistles, [72](#)
Pencil Boxes, [74](#)
Pewter Toys, [45](#)
Pewter Tea Sets, [45](#)
Pewter Soldiers, [44](#)
Photo, Albums, [3](#)
Photo, Frames, [12](#), [13](#)
Pianos, Toy, [39](#)
Pistols, [81](#)
Picture Blocks, [62](#)
Picture Puzzle Blocks, [63](#)
Plate Handles, [104](#)
Platform Horses, [31](#)
Plates, Cake, [97](#)
Playing Cards, [65](#)
Plush Horses and Carts, [31](#)
Pocket Compasses, [107](#)
Poker Chips, [65](#)
Porridge Sets, China, [95](#)
Pyramid Blocks, [63](#)

R

Rag Dolls, [89](#)
Ranges, Toy, [54](#)
Rattles, [70](#)
Razor Stropps, [110](#)
Reading Glasses, [107](#)
Rifles, Air, [81](#)
Rocking Horses, [30](#)
Rubber Dolls, [90](#)

S

Sad Irons, Toy, [54](#)
Safes, Iron, [55](#)
Safes, Steel, [47](#)
Sand Pails, [76](#)
Safety Pins, [110](#)
Sand Sets, [76](#)
Scales, [53](#)
Shawl Straps, [110](#)

Shaving Cases, [9](#)
Shaving Brushes, [110](#)
Shoo Fly Rockers, [29](#)
Sheet Steel Toys, [46](#)
Sheba, [42](#)
Shell Goods, [15](#)
Skin Rocking Horses, [30](#)
Sleighs, [26-29](#)
Smoker Sets, Celluloid, [16](#)
Soldier Dolls, [89](#)
Soldier Sets, [49](#)
Solitaire Boards, [43](#)
Souvenir, China, [99](#)
Stables, Toy, [37](#)
Steam Boats, [56](#)
Steam Engines, [56](#)
Steam Engine Attachments, [57](#)
Steel Trains, [48](#)
Steel Toys, [46](#)
Steel Safes, [47](#)
Stick Toys, [84](#)
Striking Bags, [105](#)
Strings, Musical, (special list)
Stores, Toy, [37](#)
Stoves, Toy, [54](#)
Stubborn Donkey, [79](#)
Surprise Boxes, [84](#)
Swings, Baby, [36](#)
Swings, Doll, [23](#)
Swords, Toy, [73](#)
Symphonions, (special list)

T

Table Bells, [85](#)
Tables, Toy, [21](#)
Table Sets, China, [96](#)
Tapes, Novelty, [14](#)
Tea Sets, Toy, [74](#), [76](#)
Tea Sets, Five O'clock, [96](#)
Tea, Sugar and Creams, [96](#)
Ten Pins, [43](#)

Thermometers, [107](#)
Tin Horns, [71](#)
" Tea Sets, [76](#)
" Sets, [76](#), [77](#)
Tobacco Jars, [16](#)
Toboggan Coasters, [24](#)
Toilet Sets, [8](#), [9](#)
Toilet Sundries, [108-110](#)
Toilet Cases, [4-7](#)
Tool Sets, [36](#)
Toy Watches, [72](#)
Toy Books, [67](#)
Tops, [70](#)
Trains, Steel, [48](#)
Trains, on Track, [78](#)
Trumpets, Tin, [71](#)
Trunks, Doll, [36](#)
Tumblers, Glass, [102](#)

V

Vacuum Pistol, [81](#)
Vases, [101](#)
Violins, (special list)
Violins, Toy, [39](#)

W

Water Sets, [101](#)
Watering Cans, Toy, [76](#)
War Game, [91](#)
Warehouses, Toy, [37](#)
Wash Sets, Wood, [24](#)
Wash Stands, Toy, [77](#)
Washable Dolls, [86](#)
Watches, Toy, [72](#)
Whips, Toy, [73](#)
Whistles, [72](#)
Whistles, Flute, [71](#)
Wire Easels, [104](#)
Wool Animals, [83](#)
Wool Dolls, [89](#)
Woolly Sheep, [82](#)

Wood Rocking Horses, [30](#)

Work Boxes, [14](#), [15](#)

Work Companions, [14](#)

Writing Companions, [14](#)

Writing Desks, [15](#)



Dudley & Burns, Printers



ILLUSTRATED

PRICE LIST

1900-1901

Imperial Symphonions



- Accordeons
- Violins
- Violin Sundries
- Mandolins
- Guitars, Banjos
- Auto Harps
- Musical Strings

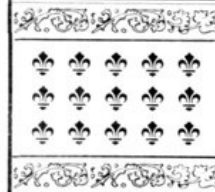
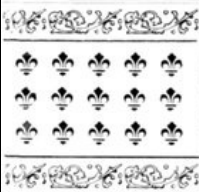

- Accordeons
- Violins
- Violin Sundries
- Mandolins
- Guitars, Banjos
- Auto Harps
- Musical Strings

NERLICH & CO.

35 Front Street West

TORONTO



DUDLEY & BURNS, PRINTERS, TORONTO

IMPERIAL SYMPHONIONS.



By a special arrangement we are able to offer these standard Instruments to the trade at much lower prices than heretofore. Investigation has convinced us that "Imperials" are easily the best Music Box on the market and we guarantee them to give perfect satisfaction.



The Imperial Symphonion

The Imperial Symphonion

The Imperial Symphonion

excels all others
in purity and
volume of tone.
has movements
with
interchangeable
parts.
is the only
Music Box
manufactured
with

The Imperial Symphonion

The Imperial Symphonion

indestructible
 steel discs.
 cases are
 artistically
 designed, of
 great
 durability, and
 resist the effect
 of all climates.
 in every respect
 is thoroughly
 up-to-date.



No. 148.

228.

28. Music Discs

110.

Each.

Spring
 movement,
 crank wind.
 Has forty steel
 tongues, one
 comb. Highly
 polished mahogany
 finish case;
 size,
 8½ × 7¾ × 6½
 inches. Price
 without music
 discs \$19
 00
 (5¾ inch) extra 20
 As cut. Spring
 movement,
 crank wind.
 Has forty-one
 steel tongues,
 one comb.
 Highly polished
 mahogany
 finish case;
 size,
 11¾ × 10 × 7
 inches. Price
 without music 23
 00



No. 110

148.

Each.

As cut. Spring movement, crank wind. Forty-eight steel tongues, one comb. Highly polished case in mahogany or oak; size, 15 x 13 x 9 inches. Price without music discs (10¼ inch) extra

\$36
00
44

48. Music Discs



No. 160.

160.

160. Music Discs

260. Duplex.

260. Music Discs

Each.

As cut. Spring movement, and crank wind.

Sixty steel tongues, one comb. Highly polished mahogany or oak case, with fancy moulding top and bottom; lock and key.

Size of case, 19 x 17 x 10³/₄ inches. Price without music discs

(13¹/₂ inch) extra

Spring movement, crank wind.

One hundred and twenty steel tongues, two combs lying on one side.

Celeste Harmony

Piccolo. Case of highly polished mahogany or oak. Size, 19 x 17 x 10³/₄ inches. Price without music

(13¹/₂ inches) each

\$60
00

70

72
00

70

**IMPERIAL SYMPHONIONS.
In Fancy Carved Cases.**



No. 106.

143. Duplex

143. Music Discs

Each.

long running
 movement.
 Celeste
 Harmony
 Piccolo. One
 hundred and
 fifty-six steel
 tongues, two
 combs lying on
 one side. Case
 of highly polished mahogany or oak, fancy moulding top and bottom, lock and key; size, 24 x 21 x 11½ inches. Price without music discs

\$120
00

(15 inch) extra 1 10
 As cut. Long running

106.

movement.
Celeste
Harmony
Piccolo. One
hundred and six
steel tongues,
two combs.
Case of highly
polished mahogany or
oak, fancy
moulding top
and bottom,
lock and key;
size,
28 × 22 × 12½
inches. Price
without music
discs 134
00
(18 inch) extra 1 80

106. Music Discs

**IMPERIAL SYMPHONIONS.
In Cabinet Grand Cases.**

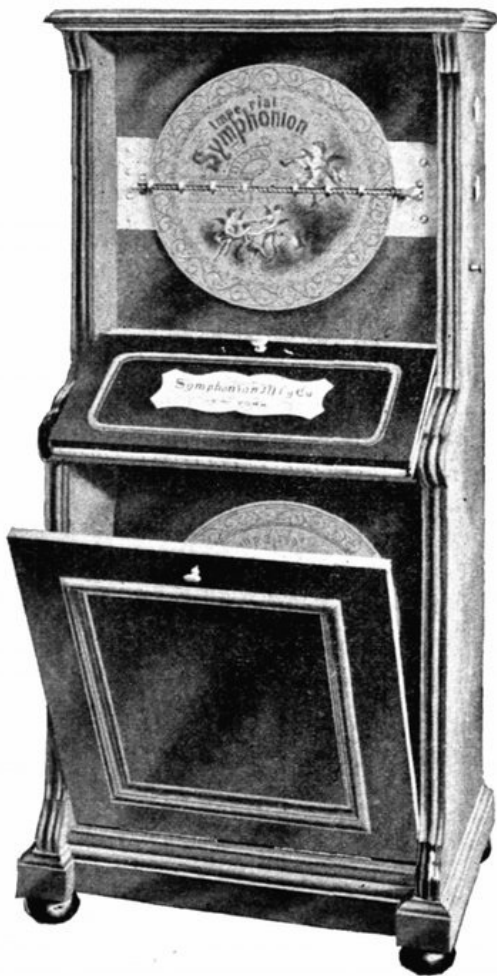

No. 106U.

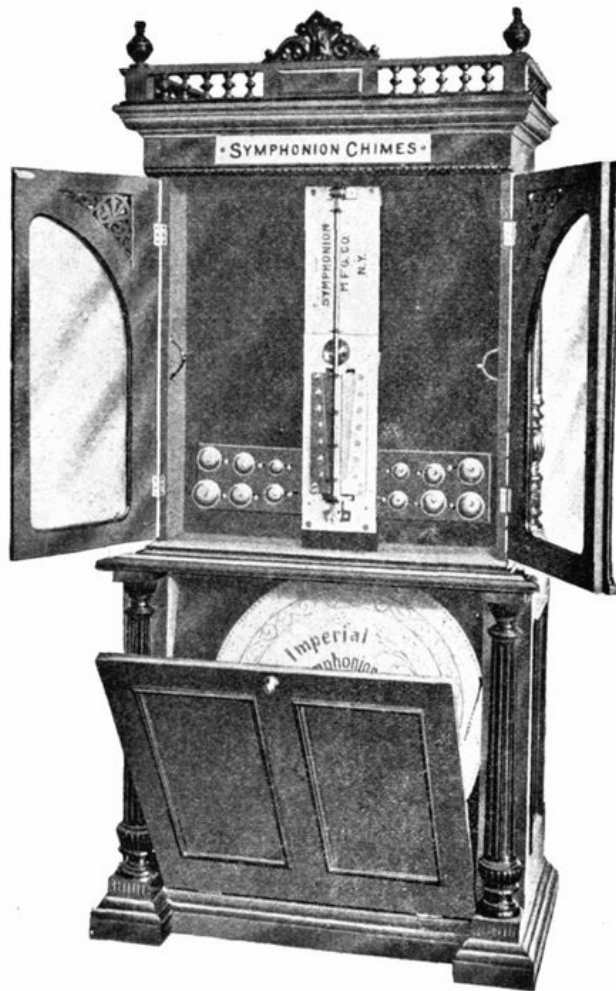

No. 192 "SYMPHONION CHIMES."

106U.

106U. Music Discs

Each.

Cabinet Grand.
 Long running
 movement,
 celeste
 harmony
 piccolo. Case,
 piano finish,
 mahogany or
 oak. Has 106
 steel tongues, 2 \$186
 combs. Loud, 00
 magnificent,
 expressive.

Partitioned disc
 drawer on base.
 Height, 61 in.;
 width, 29 in.;
 depth, 19½ in.;
 without music

(18 inch) extra 1 80

Money Drop,
 Cabinet Grand.
 Long running
 movement,
 celeste
 harmony
 piccolo. Case,
 piano finish,
 mahogany or
 oak. Has 192
 steel tongues, 2 \$450

192.

combs; 12
BELLS. Very
loud,
orchestration
tone. Disc
drawers on
base.
Automaton,
with 5 cents
money drop
attachment

00

192. Music Discs

(27½ inch)
extra

3 60

Catalogue of Music For IMPERIAL SYMPHONIONS sent on application.

ACCORDEONS,

"Empress" Make.

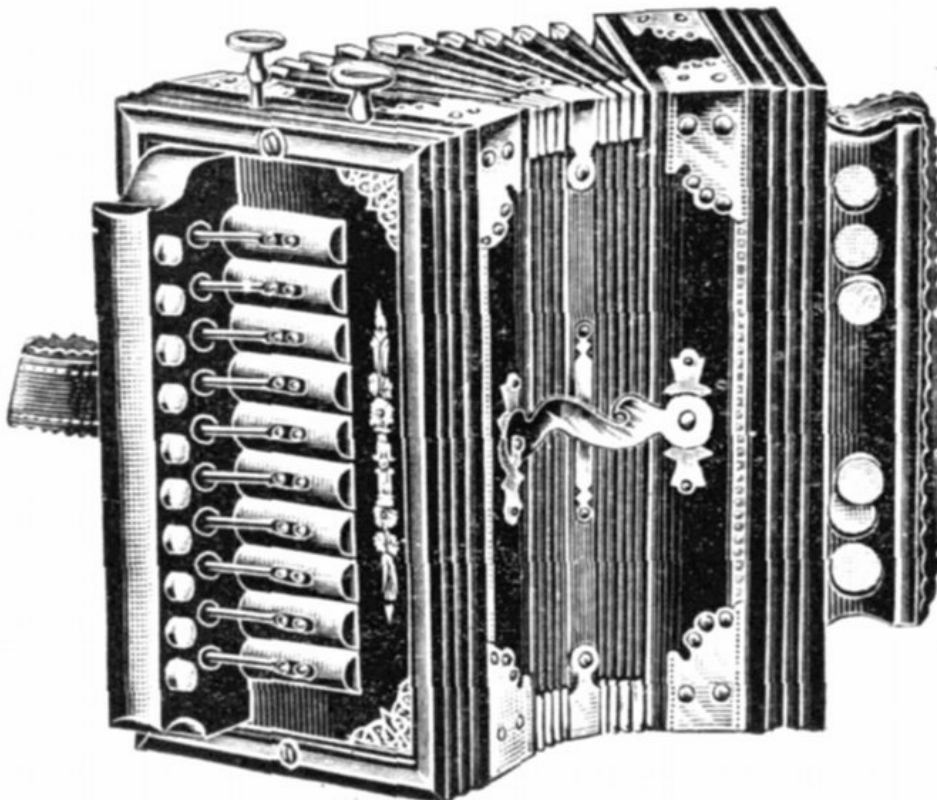

No. 81/10.

Dozen.

Small size;
black polished
case, nickel
panel moulding
and trimmings,
double bellows
with nickel
corners, two
sets broad
reeds, 2 stops,
2 basses

\$40
00

81/10.

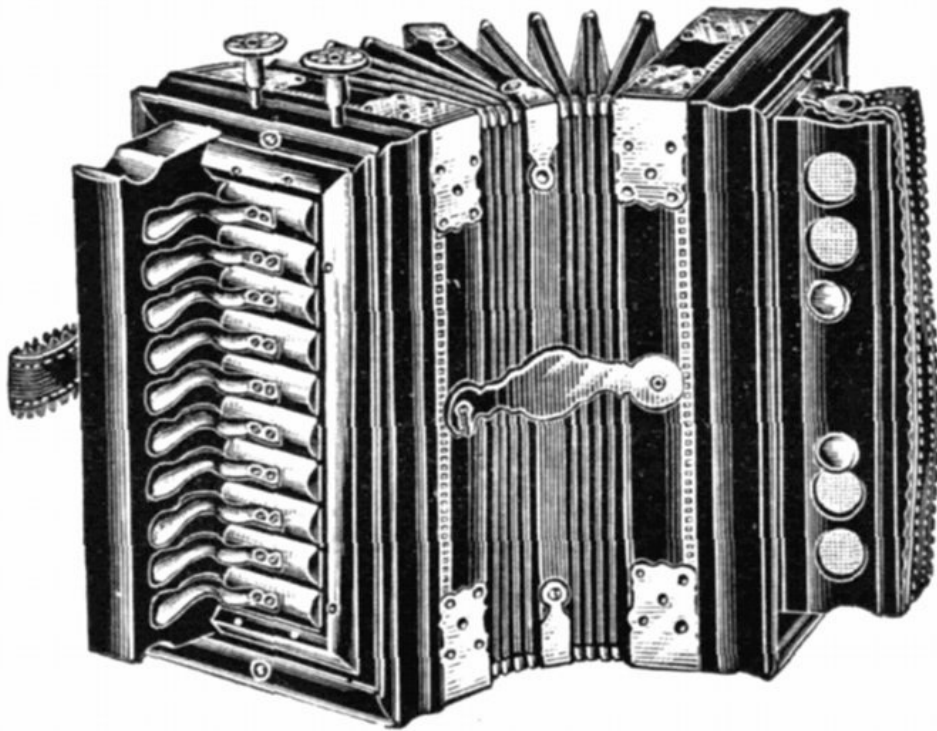

No. 81/12.

81/12.

Dozen.

Medium size;
black polished
case, nickel
panel moulding,
double bellows,
2 stops, 2
basses

\$37
50

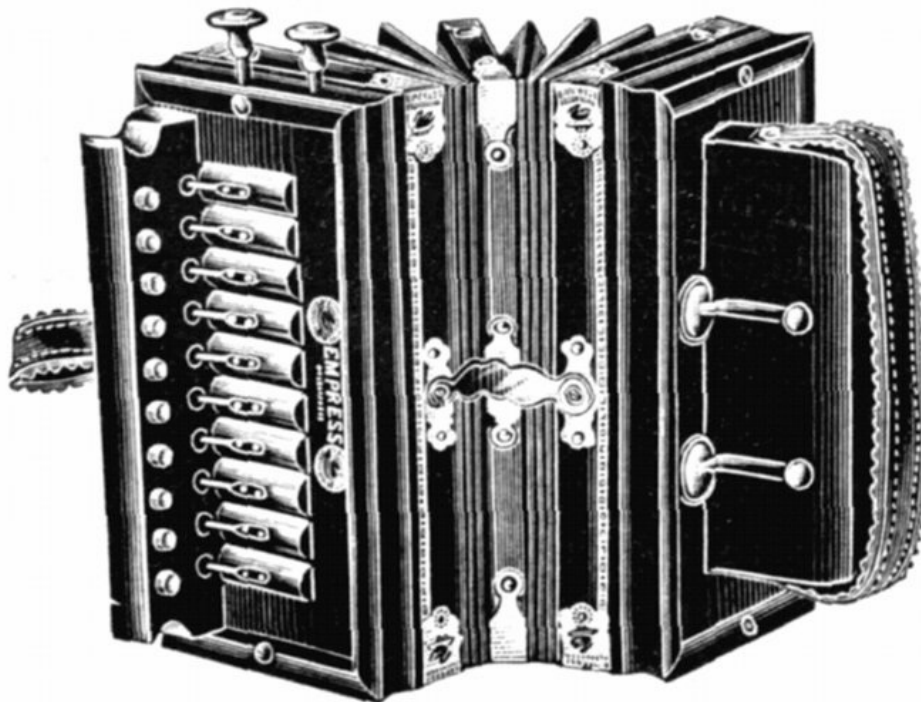

No. 81/11.

81/11.

Dozen.

Small size;
black polished
case, double
bellows, two
sets broad
reeds, 2 stops,
2 basses;
stamped
"Empress"

\$45
60

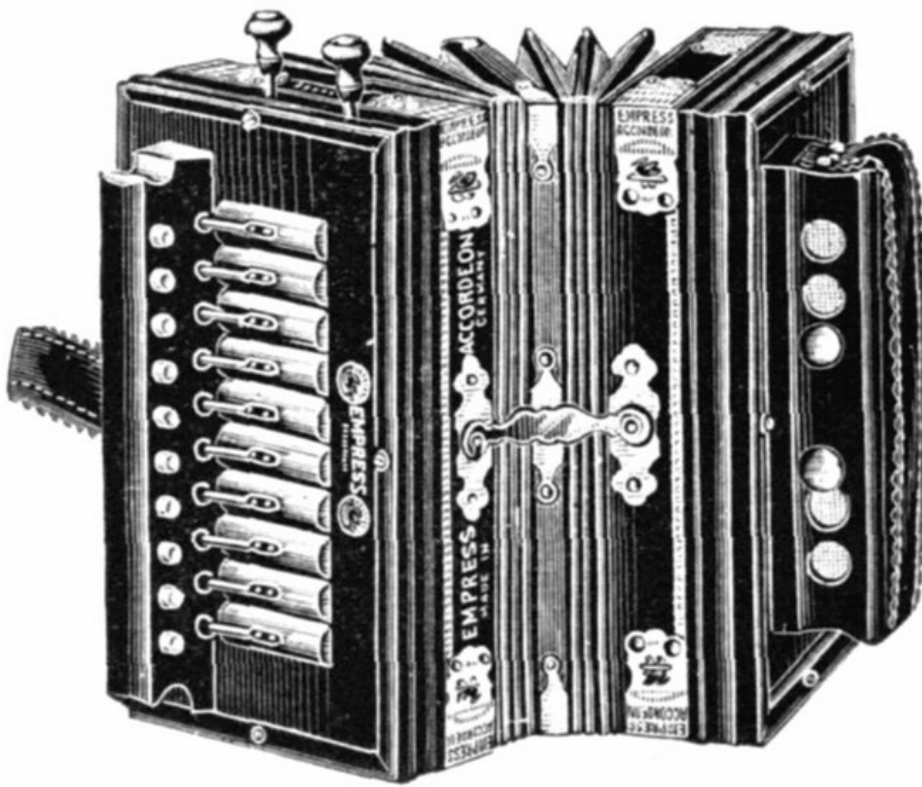

No. 81/14.

81/13.

81/14.

Dozen.

Medium size;
black polished
case, wide gilt
bands, double
bellows, two
sets broad
reeds, 2 stops,
2 basses;
stamped
"Empress"
Medium size;
black polished
case, double
bellows, two
sets broad
reeds, 2 stops,
2 basses;
stamped
"Empress"

\$48
00

51
60

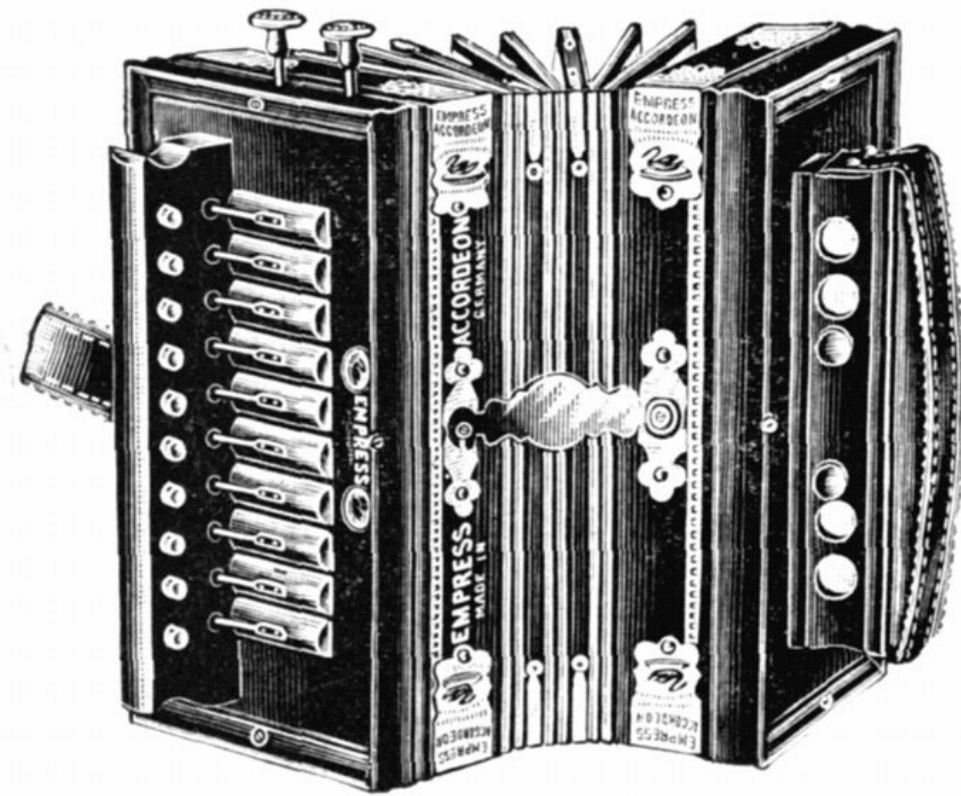

No. 81/15.

Dozen.

81/15.

Large size; black polished case, triple bellows, nickel bound all round, two sets broad reeds, 2 stops, 2 basses; stamped "Empress"

\$64
00

81/16.

Similar to above, but has large double bellows, nickel bound, two sets extra quality broad reeds; stamped "Empress"

72
00

ACCORDEONS.

Kalbe's "Imperials."

Known the world over for their excellency of finish and pure sweet tone.



501/10.

Dozen.

Medium size;
black polished
case, double
bellows, patent
clasp, two sets
of reeds, 2
stops, 2 basses

\$60
00

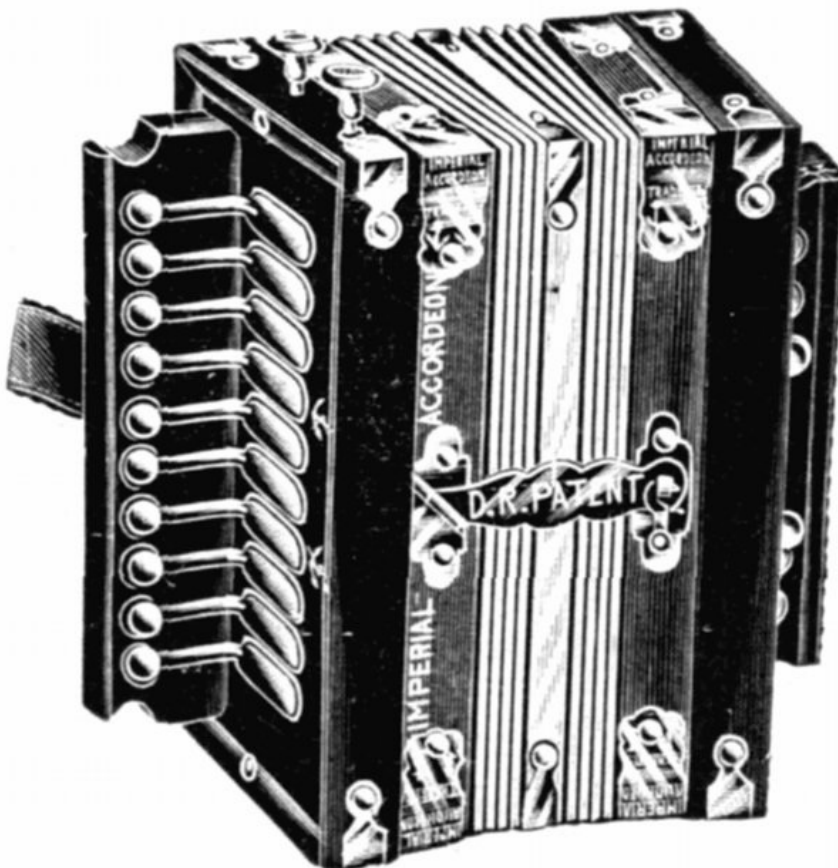

No. 502B/10.

Dozen.

502B/10.

Similar to above, but has new patent action 62
40

Medium size; rosewood case, nickel moulding;

519/10.

double bellows, patent clasp, new 20th Century patent double action, 3 stops, 2 basses \$73
20

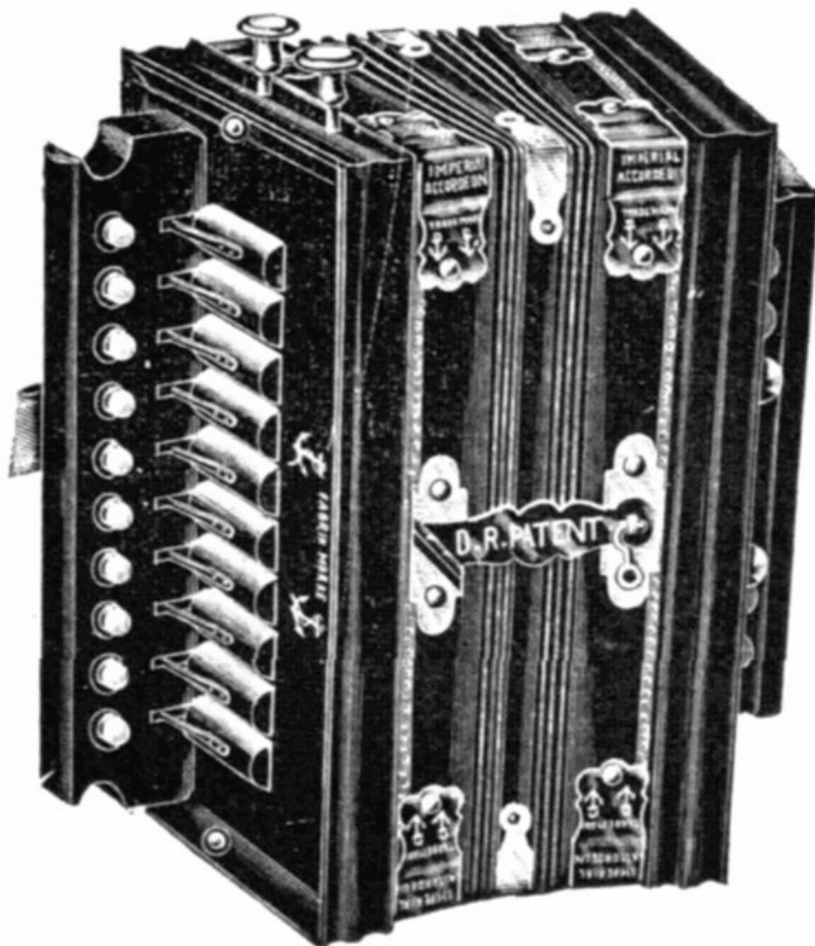

No. 500/10.

500/10.

Dozen.

"Little Lord Fauntleroy"; black polished case, silver moulding, fine nickel baguettes, double bellows, new patent clasp, two sets of broad reeds and two basses, 2 stops \$54
00

506/10.

"Little Lord Fauntleroy"; black polished case, double bellows, patent clasp, new open action, two sets of reeds, 3 stops, 2 basses 56
40

507/10.

"Little Lord Fauntleroy"; similar to above, but has nickel corner moulding and 62
40

new 20th
Century patent
double action



No. 514/10.

Dozen.

518/10.

Medium size;
black polished
case, nickel
corner
moulding,
double bellows, \$72
patent clasp, 00
new 20th

514/10.

Century patent
double action, 2
stops, 2 basses
Medium size;
black polished
case, nickel
panel moulding,
double bellows; 78
new open 00
action, as
illustrated in
cut, 2 stops, 2
basses

VIOLINS.



7. Hopf,

9. Salzard,

9³/₄. Salzard,

13. Fine Quality,

17. Stradivarius Model,

21. Stradivarius,

Above Prices are for the Violins with Strings and Bridges only. Bows are Extra.

Dozen.

good shape,	\$36
fine finish, red shaded	00
red shaded	42
three-quarter size, red shaded	42
brown shaded,	48
ebony tail-piece	00
good quality,	64
light brown shaded	00
brown shaded,	90
fine quality	00

VIOLIN CASES.

Each.

5250.

Wood, black varnished	
finish, half lined, new	\$1 60
swell-shape top, patent hooks	

5251.

As above, but full lined and has lock	2 00
---------------------------------------	------

5251A.

Wood, black varnished	
finish, curved sides, full lined, spring clasps and lock	2 60

VIOLIN SUNDRIES.

Bows.

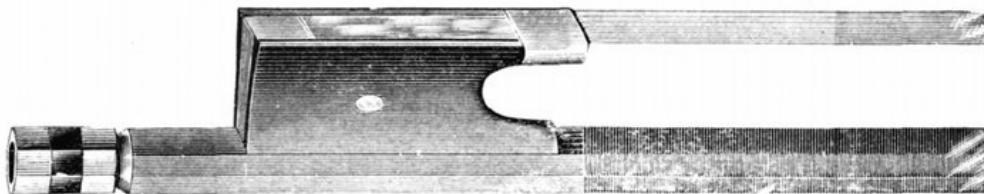

No. 320.

Dozen.

8.	Beechwood, bone button, black frog	\$ 3 60
230.	Beechwood stick, ebony frog, pearl slide, German silver button	7 20
18¼.	Brazilwood, ebony frog, pearl dot and slide, German silver button and half G. S. lined	10 00
90.	Similar to 18¼, but is full German silver lined	11 50
100.	Brazilwood, ebony frog, pearl dot and slide, German silver button and full G. S. lined, leather wound	15 00
139.	Brazilwood, stamped "Tourte," ebony frog, leather wound, German silver trimmed throughout	19 20
98.	Snakewood, warranted genuine, stamped "Brusch," ebony frog, full German silver trimmed	24 00
125.	Snakewood, warranted genuine, ebony frog, full German silver trimmed, best quality	30 00

Bow Hair.

12.	Siberian, finest bleached, extra long	\$ 3 00
------------	---	------------

Tail Pieces.

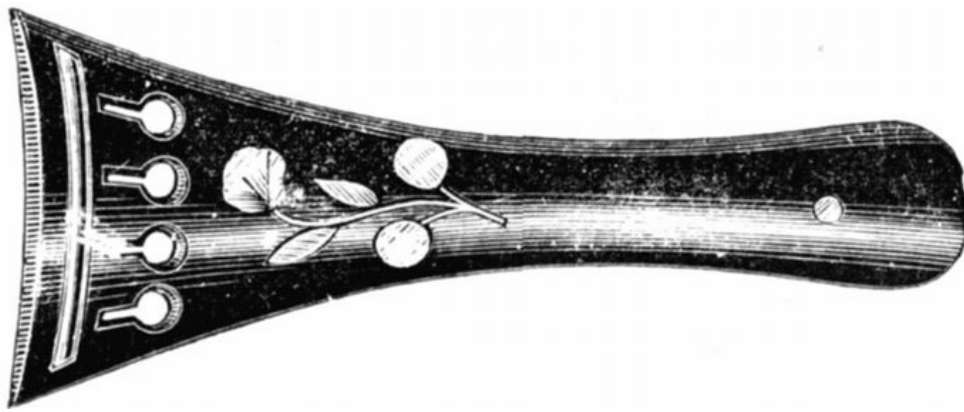

No. 11.

- 7.
- 10.
- 11.
- 132.

Dozen.

Imitation ebony, plain	\$1 00
Imitation ebony, pearl inlaid	1 50
Imitation ebony, polished, inlaid pearl flowers	3 00
Ebony, Italian shape	3 00

Bridges.

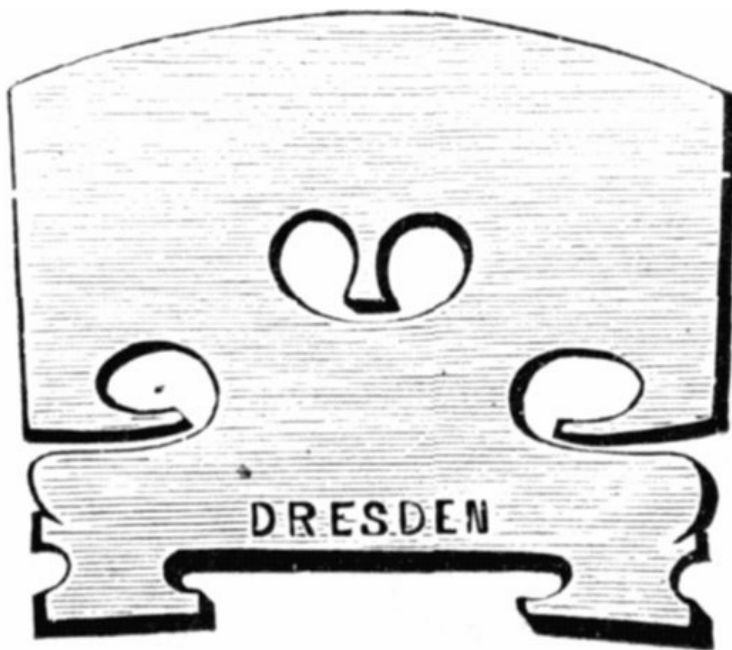

- 12.

Dozen.

Maplewood, good quality	\$ 0 50
" best	

Pegs.

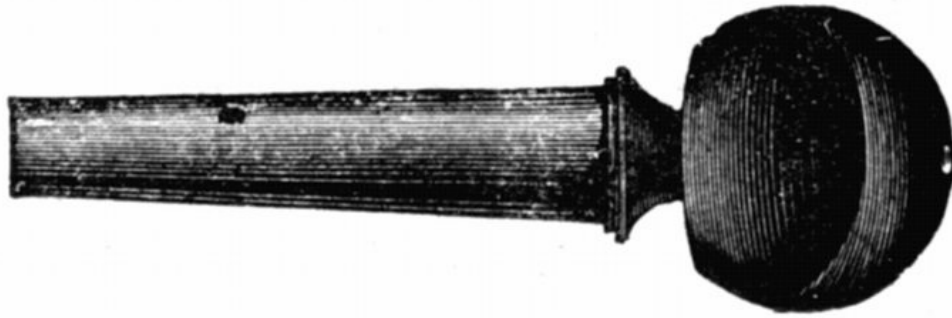

7.

25.

Dozen.

Imitation ebony	\$ 0
Genuine ebony,	50
pearl dot	70

Resin.

Best Imported

Dozen.

30c. and	\$0
	80

Chin Rest.

68.

Dozen.

Nickel frame,	\$ 5
ebony rest	50

Patent Head.

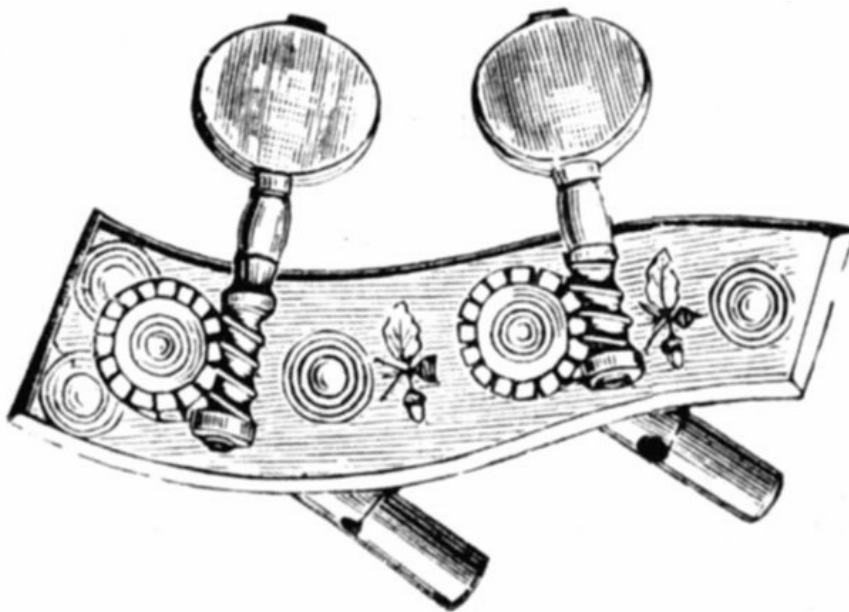

Per Set.

537.

Brass, with	\$ 0
bone buttons	60

MANDOLINS.



53.

Each.

Walnut and maple; 13 ribs, white edge, orange top, inlaid position dots on fingerboard, brass patent head, nickel plate tail piece, inlaid around sound hole, celluloid guard plate, nicely finished

\$4
30

54.

Same as 53, but celluloid bound edge

4 80

5201.

Walnut, bird's-eye maple, 9 ribs, orange or white colored top, neck finished in mahogany; rosewood fingerboard, position dots. Inlaid around sound hole, brass machine head, nickel plated tail-piece and guard. Fine tone and finish
Solid rosewood, 11 ribs with inlaid strips between, spruce top finished in

7 00

5204.

white,
mahogany
neck, rosewood
fingerboard and
fancy pearl
position dots.
Inlaid sound
hole plate and
guard plate,
brass machine
head, nickel
tail-piece and
protector. Fine
tone and finish

15
00

MANDOLIN CASE.

1569.

Each.

Strong canvas,
leather bound,
flannel lined,
strap fastening
and handle,
opens at top.
Extra quality

\$2
50

GUITARS.



	Each.	
5100.	Imitation mahogany, ebonized fingerboard. Inlaid rings around sound hole, orange color top, brass machine head, position dots. Good tone and finish	\$6 00
5101.	As above, but imitation rosewood, and is better finished	6 80
5102.	Antique oak with inlaid strip, orange colored top. Brass machine head, rosewood fingerboard, pearl position dots. Inlaid around sound hole. A finely finished and sweet toned instrument	8 50
5104.	New model. Solid mahogany, inlaid strip down back, inlaid around sound hole, mahogany neck, nicely inlaid fingerboard, selected white spruce top. An extra fine instrument	12 50

GUITAR CASE.

	Each.	
588.	Strong canvas, leather bound, fleece lined; strap handle; opens at end. Standard size	\$2 80

BANJOS.



56.

57.

58.

Each.

Eleven-inch
nickel shell,
wood lined,
birch neck, 13
brass leaf
brackets, raised
frets \$7
00

As 56, but has
17 brass leaf
brackets 8 00

Nickel shell,
wood lined,
wire edge,
birch neck,
ebony pegs,
grooved hoop,
metal tail-piece;
13 hexagon
brackets, all
parts finely
nickel plated 12
00

AUTOHARPS.

Fine tone and finish. Each instrument is packed in stained and varnished WOOD BOX, complete with picks and instruction book.

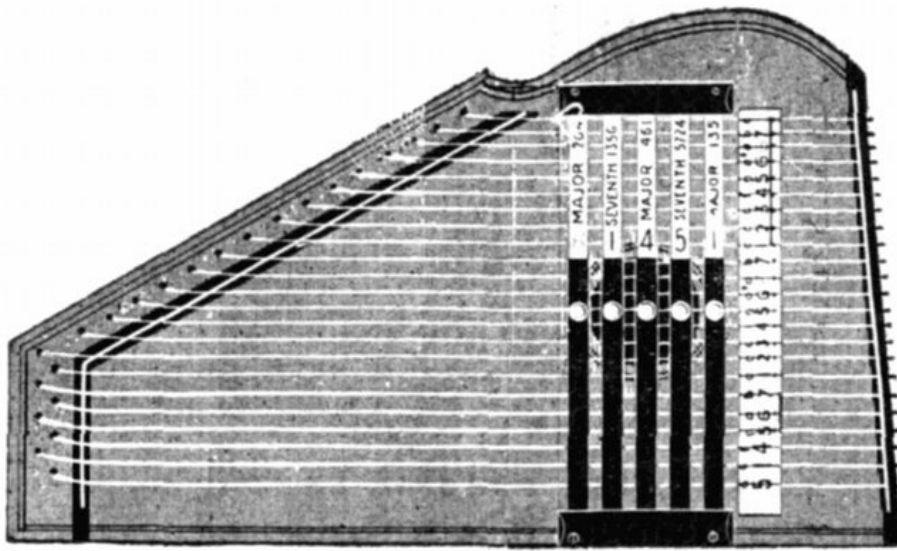

51.

52.

52³/₄.

52³/₄A.

52³/₄B.

52³/₄C.

Each.

Twenty-three strings, **three bars**, producing three chords \$2 70
 Twenty three strings, **four bars**, producing four chords 3 00
 Twenty-three strings, **five bars**, producing five chords 3 20
 Twenty three strings, **six bars**, producing six chords 3 60
 Twenty five strings, **five bars**, producing five chords. 4 50
 Extra large size
 Twenty-five strings, **six bars**, producing six chords. 5 00
 Extra large size

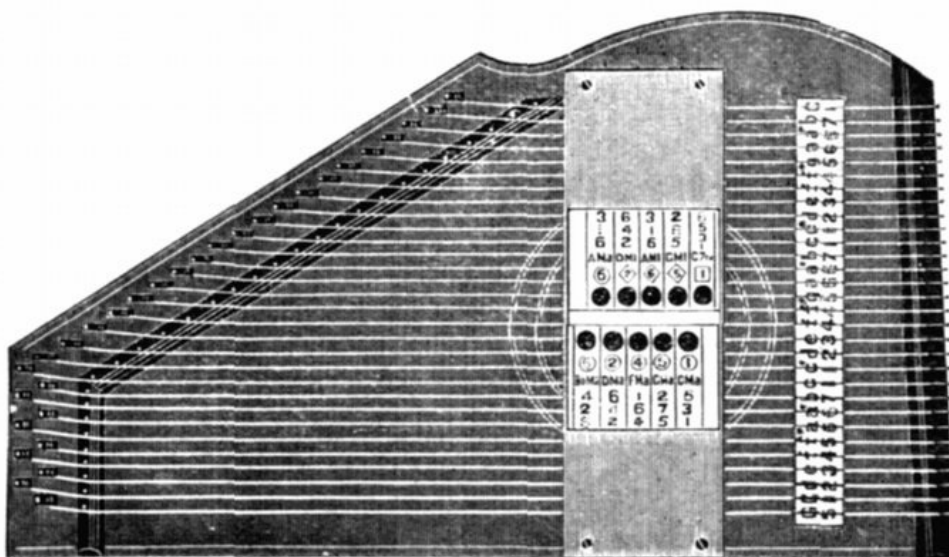

510½.

Each.

As cut, 10 new style covered bars. Fine finish \$6 50

MUSICAL STRINGS.

Violin Strings, Gut.

Per Bundle.

E Sarasate,

four lengths, extra fine quality, clear Italian string, each wrapped in oil paper and tin foil, bearing trademark and tied with silk ribbon (30 strings in bundle) \$ 6 00

E 500. "Triumph,"

Genuine Caucasian gut, four lengths, each string wrapped in tin foil 4 50

E 43½. Naples,

four lengths, fine quality, silver wire tied 4 00

E 140.

Four lengths, polished, extra quality transparent gut 3 00

E 30.

Fine quality, three lengths 2 50

E 9.

Fine quality Roman string, transparent 1 30

A 500.

An A string in same quality as E 500 4 50

A 24.

Finest quality Roman string, two and one-half lengths 4 00

A 16.

Best quality Roman string, two and one-half lengths 3 00

A 9.

Fine quality Roman string, two and one-half lengths 1 30

D 19.

Best quality Roman string, two and one-half lengths 4 00

D 12.

Fine quality Roman string, two and one-half lengths 3 00
Fine quality Roman string,

D 9.	two and one-half lengths	2 20
	Dozen.	
G 30.	Extra fine quality silver wire, wound on best gut, dark yellow ends, 1 dozen in box	\$ 1 00
G 26.	Fine quality silver wire, wound on gut, dark yellow ends	60
G 346.	Flat wire, burnished, wound on gut	50
	Dozen Sets.	
Brentano's Violin Set,	assortment of strings, put up in neat tin box, as follows: 2 E; 1 A;> 1 D; 1 G	\$ 7 20

In Assortments.

Per Box.

745/2½	consists of 30 strings in flat cardboard boxes divided into compartments, contains 15 E gut strings, 8 A gut strings, 4 D gut strings, and 3 G strings	\$ 3 00
Our Challenge	assortment as above, but finer quality, and is in tin compartment box	5 00
Ole Bull	assortment, as above	6 00

Violin Strings, Steel.

	Gross.	
E.	Silvered, one dozen in box	\$ 2 40
A.	" " " "	2 40
D.	" " " "	2 40
G.	" wound, one dozen in a box	6 00
	Dozen Sets.	
Belvedere Steel Set,	2 E, 1 A, 1 D and 1 G, silvered steel	\$ 2 00

Guitar Strings.

The following three strings are superior Italian stock.

	Dozen.	
D 33.	Finest quality, spun on white silk, fancy ends	\$ 1 40
A 33.	Finest quality, spun on white silk, fancy ends	1 40
E 33.	Finest quality, spun on white silk, fancy ends	1 40

Guitar Strings Wound on Steel Wire.

	Dozen.		
G or 3rd,		wound on finest	\$ 0
		steel wire	80
D or 4th,		" " "	80
A or 5th,		" " "	80
E or 6th,		" " "	1 00
	Dozen Sets.		
450 Set, Gut and Silk,		one each, 1st, 2nd, 3rd, 4th, 5th and 6th	\$12 00
Steel Set,		one each, 1st, 2nd, 3rd, 4th, 5th and 6th	4 00
	Gross.		\$3 00
Guitar Steel Strings, E, B or G			

Banjo Strings—Steel.

	Gross.		
1st or 5th,		Silvered steel	\$ 3
		wire	00
2nd		" "	3 00
3rd		" "	3 00
4th		Spun on steel, 36 inches long	7 20

Banjo Sets.

Per Set.

		assortment as follows—Three	
350. Set, Gut and Silk,		1st, two 2nd, one each 3rd and 4th, fine quality	\$ 1 00
35. Set, Gut and Silk		assortment as above	50
600. Steel Set,		silvered wire	20

Mandolin Strings.

	Dozen.		
1st		Silvered steel	\$ 0
		wire	30
2nd		" "	30
3rd		Wound on steel	
		wire	60
4th		" "	80
1209 Steel Set		Dozen sets,	3 60

CLOVER HARMONIPHONE.



The Clover Harmoniphone is an entirely new and novel invention, combining one of the famous Clover Harmonicas with a metal Phone. The Phone adds greatly to the richness and purity of tone and increases the volume many times over. Acting like a horn on a phonograph it takes up every note whether faint or loud and sends them forth with wonderful effect. One Phone will last a lifetime as it is fitted with flanges from which the mouth organ can be detached or replaced at will. Each Harmoniphone is packed in wooden box complete with instruction book. Per doz.

\$9
60

MATHEMATICAL INSTRUMENTS.

Nickel-plated Instruments. Leatherette Cases. Velvet-lined.

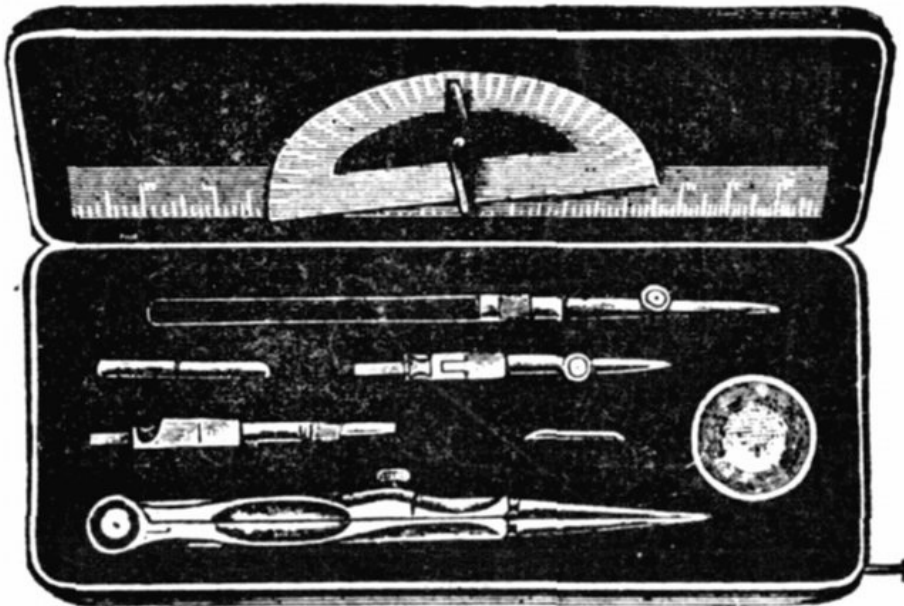

No. 14/709.

Dozen Sets.

14/708.

Similar to cut. Eight piece set, containing, divider, pen and pencil points, box of leads, tightening key, protractor, wood rule and saucer. Size of case, 6 x 2½ inches

\$6
50

14/709.	As cut. Similar to above but with ruling pen. Size of case, 6½ × 2¾ inches	\$8 40
14/710.	Eleven piece set, containing divider, pen and pencil points, lengthening arm, box of leads, tightening key, ruling pen, metal protractor, polished wood rule, square and saucer. Size of case, 6½ × 3 inches	12 00
14/711.	As above, but contains two pair of dividers. Size of case, 6½ × 3½ inches	14 40
Dozen Sets.		
147/12.	As 14/710, but is without saucer and contains two pair of dividers and lengthening arm. Size of case, 6½ × 3½ inches	18 00
147/13.	Similar to above with addition of spring arch pen compass. Size, 6½ × 3¾ inches	27 00

Have also fine quality 8 piece compass sets in half leather covered cases, at \$5.50 and \$6.50 per set.

ASK FOR OUR
PRICES ON GLASS
ALLEYS AND
MARBLES.



"KING" AIR RIFLES.

New Dart Model Just Out.

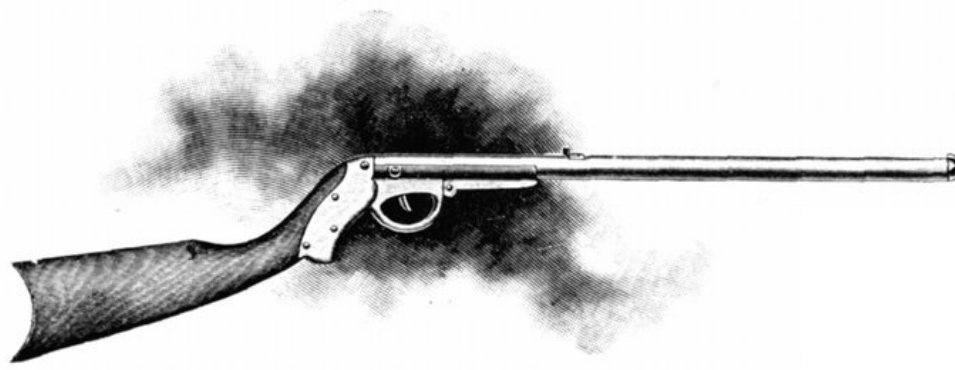

"KING" Single Shot.

Dozen.

New Model, as cut. **Shoots Darts or B B. Shot.** Polished wood stock, all metal parts made entirely of steel, nickel plated. The new Dart Attachment

\$19
20



"KING" Repeater.

Dozen.

As cut. Polished wood stock, all metal parts made entirely of steel, nickel plated. Fitted with perfect working repeating magazine

\$27
00

Length of above rifles, 31 inches; Weight, about 2 lbs. each.
Prices subject to our Regular Catalogue Discount and Terms.

REMOVAL NOTICE

About January 1st, 1901, we remove to our new Warehouse being erected directly opposite the Union Station, Front St. West. This new building will give us under one roof more than double the space we now occupy in our two warehouses, and will be equipped with every "up-to-date" convenience for the careful, prompt and economic handling of merchandise in our line.

We are preparing to show in our new premises largely increased ranges in all departments.

In our new Sample Rooms we will also show a very large line of Fancy Goods for Import Orders.

NERLICH & CO.



General Catalogue on Application.

NERLICH & CO.

FANCY GOODS, DOLLS, TOYS, GAMES, GLASS AND CHINA WARE

TORONTO

General Catalogue on Application.

Transcriber's Notes:

Table of contents created by transcriber.

Silently corrected simple spelling, grammar, and typographical errors.

Retained anachronistic and non-standard spellings as printed.

*** END OF THE PROJECT GUTENBERG EBOOK FALL AND HOLIDAY TRADE, SEASON 1900-1901,
NERLICH & CO. ILLUSTRATED CATALOGUE ***

Updated editions will replace the previous one—the old editions will be renamed.

Creating the works from print editions not protected by U.S. copyright law means that no one owns a United States copyright in these works, so the Foundation (and you!) can copy and distribute it in the United States without permission and without paying copyright royalties. Special rules, set forth in the General Terms of Use part of this license, apply to copying and distributing Project Gutenberg™ electronic works to protect the PROJECT GUTENBERG™ concept and trademark. Project Gutenberg is a registered trademark, and may not be used if you charge for an eBook, except by following the terms of the trademark license, including paying royalties for use of the Project Gutenberg trademark. If you do not charge anything for copies of this eBook, complying with the trademark license is very easy. You may use this eBook for nearly any purpose such as creation of derivative works, reports, performances and research. Project Gutenberg eBooks may be modified and printed and given away—you may do practically ANYTHING in the United States with eBooks not protected by U.S. copyright law. Redistribution is subject to the trademark license, especially commercial redistribution.

START: FULL LICENSE THE FULL PROJECT GUTENBERG LICENSE PLEASE READ THIS BEFORE YOU DISTRIBUTE OR USE THIS WORK

To protect the Project Gutenberg™ mission of promoting the free distribution of electronic works, by using or distributing this work (or any other work associated in any way with the phrase “Project Gutenberg”), you agree to comply with all the terms of the Full Project Gutenberg™ License available with this file or online at www.gutenberg.org/license.

Section 1. General Terms of Use and Redistributing Project Gutenberg™ electronic works

1.A. By reading or using any part of this Project Gutenberg™ electronic work, you indicate that you have read, understand, agree to and accept all the terms of this license and intellectual property (trademark/copyright) agreement. If you do not agree to abide by all the terms of this agreement, you must cease using and return or destroy all copies of Project Gutenberg™ electronic works in your possession. If you paid a fee for obtaining a copy of or access to a Project Gutenberg™ electronic work and you do not agree to be bound by the terms of this agreement, you may obtain a refund from the person or entity to whom you paid the fee as set forth in paragraph 1.E.8.

1.B. “Project Gutenberg” is a registered trademark. It may only be used on or associated in any way with an electronic work by people who agree to be bound by the terms of this agreement. There are a few things that you can do with most Project Gutenberg™ electronic works even without complying with the full terms of this agreement. See paragraph 1.C below. There are a lot of things you can do with Project Gutenberg™ electronic works if you follow the terms of this agreement and help preserve free future access to Project Gutenberg™ electronic works. See paragraph 1.E below.

1.C. The Project Gutenberg Literary Archive Foundation (“the Foundation” or PGLAF), owns a compilation copyright in the collection of Project Gutenberg™ electronic works. Nearly all the individual works in the collection are in the public domain in the United States. If an individual work is unprotected by copyright law in the United States and you are located in the United States, we do not claim a right to prevent you from copying, distributing, performing, displaying or creating derivative works based on the work as long as all references to Project Gutenberg are removed. Of course, we hope that you will support the Project Gutenberg™ mission of promoting free access to electronic works by freely sharing Project Gutenberg™ works in compliance with the terms of this agreement for keeping the Project Gutenberg™ name associated with the work. You can easily comply with the terms of this agreement by keeping this work in the same format with its attached full Project Gutenberg™ License when you share it without charge with others.

1.D. The copyright laws of the place where you are located also govern what you can do with this work. Copyright laws in most countries are in a constant state of change. If you are outside the United States, check the laws of your country in addition to the terms of this agreement before downloading, copying, displaying, performing, distributing or creating derivative works based on this work or any other Project Gutenberg™ work. The Foundation makes no representations concerning the copyright status of any work in any country other than the United States.

1.E. Unless you have removed all references to Project Gutenberg:

1.E.1. The following sentence, with active links to, or other immediate access to, the full Project Gutenberg™ License must appear prominently whenever any copy of a Project Gutenberg™ work (any work on which the phrase “Project Gutenberg” appears, or with which the phrase “Project Gutenberg” is associated) is accessed, displayed, performed, viewed, copied or distributed:

This eBook is for the use of anyone anywhere in the United States and most other parts of the world at no cost and with almost no restrictions whatsoever. You may copy it, give it away or re-use it under the terms of the Project Gutenberg License included with this eBook or online at www.gutenberg.org. If you are not located in the United States, you will have to check the laws of the country where you are located before using this eBook.

1.E.2. If an individual Project Gutenberg™ electronic work is derived from texts not protected by U.S. copyright law (does not contain a notice indicating that it is posted with permission of the copyright holder), the work can be copied and distributed to anyone in the United States without paying any fees or charges. If you are redistributing or providing access to a work with the phrase “Project Gutenberg” associated with or appearing on the work, you must comply either with the requirements of paragraphs 1.E.1 through 1.E.7 or obtain permission for the use of the work and the Project Gutenberg™ trademark as set forth in paragraphs 1.E.8 or 1.E.9.

1.E.3. If an individual Project Gutenberg™ electronic work is posted with the permission of the copyright holder, your use and distribution must comply with both paragraphs 1.E.1 through 1.E.7 and any additional terms imposed by the copyright holder. Additional terms will be linked to the Project Gutenberg™ License for all works posted with the permission of the copyright holder found at the beginning of this work.

1.E.4. Do not unlink or detach or remove the full Project Gutenberg™ License terms from this work, or any files containing a part of this work or any other work associated with Project Gutenberg™.

1.E.5. Do not copy, display, perform, distribute or redistribute this electronic work, or any part of this electronic work, without prominently displaying the sentence set forth in paragraph 1.E.1 with active links or immediate access to the full terms of the Project Gutenberg™ License.

1.E.6. You may convert to and distribute this work in any binary, compressed, marked up, nonproprietary or proprietary form, including any word processing or hypertext form. However, if you provide access to or distribute copies of a Project Gutenberg™ work in a format other than “Plain Vanilla ASCII” or other format used in the official version posted on the official Project Gutenberg™ website (www.gutenberg.org), you must, at no additional cost, fee or expense to the user, provide a copy, a means of exporting a copy, or a means of obtaining a copy upon request, of the work in its original “Plain Vanilla ASCII” or other form. Any alternate format must include the full Project Gutenberg™ License as specified in paragraph 1.E.1.

1.E.7. Do not charge a fee for access to, viewing, displaying, performing, copying or distributing any Project Gutenberg™ works unless you comply with paragraph 1.E.8 or 1.E.9.

1.E.8. You may charge a reasonable fee for copies of or providing access to or distributing Project Gutenberg™ electronic works provided that:

- You pay a royalty fee of 20% of the gross profits you derive from the use of Project Gutenberg™ works calculated using the method you already use to calculate your applicable taxes. The fee is owed to the owner of the Project Gutenberg™ trademark, but he has agreed to donate royalties under this paragraph to the Project Gutenberg Literary Archive Foundation. Royalty payments must be paid within 60 days following each date on which you prepare (or are legally required to prepare) your periodic tax returns. Royalty payments should be clearly marked as such and sent to the Project Gutenberg Literary Archive Foundation at the address specified in Section 4, “Information about donations to the Project Gutenberg Literary Archive Foundation.”
- You provide a full refund of any money paid by a user who notifies you in writing (or by e-mail) within 30 days of receipt that s/he does not agree to the terms of the full Project Gutenberg™ License. You must require such a user to return or destroy all copies of the works possessed in a physical medium and discontinue all use of and all access to other copies of Project Gutenberg™ works.
- You provide, in accordance with paragraph 1.F.3, a full refund of any money paid for a work or a replacement copy, if a defect in the electronic work is discovered and reported to you within 90 days of receipt of the work.
- You comply with all other terms of this agreement for free distribution of Project Gutenberg™ works.

1.E.9. If you wish to charge a fee or distribute a Project Gutenberg™ electronic work or group of works on different terms than are set forth in this agreement, you must obtain permission in writing from the Project Gutenberg Literary Archive Foundation, the manager of the Project Gutenberg™ trademark. Contact the Foundation as set forth in Section 3 below.

1.F.

1.F.1. Project Gutenberg volunteers and employees expend considerable effort to identify, do copyright research on, transcribe and proofread works not protected by U.S. copyright law in creating the Project Gutenberg™ collection. Despite these efforts, Project Gutenberg™ electronic works, and the medium on which they may be stored, may contain “Defects,” such as, but not limited to, incomplete, inaccurate or corrupt data, transcription errors, a copyright or other intellectual property infringement, a defective or damaged disk or other medium, a computer virus, or computer codes that damage or cannot be read by your equipment.

1.F.2. LIMITED WARRANTY, DISCLAIMER OF DAMAGES - Except for the "Right of Replacement or Refund" described in paragraph 1.F.3, the Project Gutenberg Literary Archive Foundation, the owner of the Project Gutenberg™ trademark, and any other party distributing a Project Gutenberg™ electronic work under this agreement, disclaim all liability to you for damages, costs and expenses, including legal fees. YOU AGREE THAT YOU HAVE NO REMEDIES FOR NEGLIGENCE, STRICT LIABILITY, BREACH OF WARRANTY OR BREACH OF CONTRACT EXCEPT THOSE PROVIDED IN PARAGRAPH 1.F.3. YOU AGREE THAT THE FOUNDATION, THE TRADEMARK OWNER, AND ANY DISTRIBUTOR UNDER THIS AGREEMENT WILL NOT BE LIABLE TO YOU FOR ACTUAL, DIRECT, INDIRECT, CONSEQUENTIAL, PUNITIVE OR INCIDENTAL DAMAGES EVEN IF YOU GIVE NOTICE OF THE POSSIBILITY OF SUCH DAMAGE.

1.F.3. LIMITED RIGHT OF REPLACEMENT OR REFUND - If you discover a defect in this electronic work within 90 days of receiving it, you can receive a refund of the money (if any) you paid for it by sending a written explanation to the person you received the work from. If you received the work on a physical medium, you must return the medium with your written explanation. The person or entity that provided you with the defective work may elect to provide a replacement copy in lieu of a refund. If you received the work electronically, the person or entity providing it to you may choose to give you a second opportunity to receive the work electronically in lieu of a refund. If the second copy is also defective, you may demand a refund in writing without further opportunities to fix the problem.

1.F.4. Except for the limited right of replacement or refund set forth in paragraph 1.F.3, this work is provided to you 'AS-IS', WITH NO OTHER WARRANTIES OF ANY KIND, EXPRESS OR IMPLIED, INCLUDING BUT NOT LIMITED TO WARRANTIES OF MERCHANTABILITY OR FITNESS FOR ANY PURPOSE.

1.F.5. Some states do not allow disclaimers of certain implied warranties or the exclusion or limitation of certain types of damages. If any disclaimer or limitation set forth in this agreement violates the law of the state applicable to this agreement, the agreement shall be interpreted to make the maximum disclaimer or limitation permitted by the applicable state law. The invalidity or unenforceability of any provision of this agreement shall not void the remaining provisions.

1.F.6. INDEMNITY - You agree to indemnify and hold the Foundation, the trademark owner, any agent or employee of the Foundation, anyone providing copies of Project Gutenberg™ electronic works in accordance with this agreement, and any volunteers associated with the production, promotion and distribution of Project Gutenberg™ electronic works, harmless from all liability, costs and expenses, including legal fees, that arise directly or indirectly from any of the following which you do or cause to occur: (a) distribution of this or any Project Gutenberg™ work, (b) alteration, modification, or additions or deletions to any Project Gutenberg™ work, and (c) any Defect you cause.

Section 2. Information about the Mission of Project Gutenberg™

Project Gutenberg™ is synonymous with the free distribution of electronic works in formats readable by the widest variety of computers including obsolete, old, middle-aged and new computers. It exists because of the efforts of hundreds of volunteers and donations from people in all walks of life.

Volunteers and financial support to provide volunteers with the assistance they need are critical to reaching Project Gutenberg™'s goals and ensuring that the Project Gutenberg™ collection will remain freely available for generations to come. In 2001, the Project Gutenberg Literary Archive Foundation was created to provide a secure and permanent future for Project Gutenberg™ and future generations. To learn more about the Project Gutenberg Literary Archive Foundation and how your efforts and donations can help, see Sections 3 and 4 and the Foundation information page at www.gutenberg.org.

Section 3. Information about the Project Gutenberg Literary Archive Foundation

The Project Gutenberg Literary Archive Foundation is a non-profit 501(c)(3) educational corporation organized under the laws of the state of Mississippi and granted tax exempt status by the Internal Revenue Service. The Foundation's EIN or federal tax identification number is 64-6221541. Contributions to the Project Gutenberg Literary Archive Foundation are tax deductible to the full extent permitted by U.S. federal laws and your state's laws.

The Foundation's business office is located at 809 North 1500 West, Salt Lake City, UT 84116, (801) 596-1887. Email contact links and up to date contact information can be found at the Foundation's website and official page at www.gutenberg.org/contact

Section 4. Information about Donations to the Project Gutenberg Literary Archive Foundation

Project Gutenberg™ depends upon and cannot survive without widespread public support and donations to carry out its mission of increasing the number of public domain and licensed works that can be freely distributed in machine-readable form accessible by the widest array of equipment including outdated equipment. Many small donations (\$1 to \$5,000) are particularly important to maintaining tax exempt status with the IRS.

The Foundation is committed to complying with the laws regulating charities and charitable donations in all 50 states of the United States. Compliance requirements are not uniform and it takes a considerable effort, much paperwork and many fees to meet and keep up with these requirements. We do not solicit donations in locations where we have not received written confirmation of compliance. To SEND DONATIONS or determine the status of compliance for any particular state visit www.gutenberg.org/donate.

While we cannot and do not solicit contributions from states where we have not met the solicitation requirements, we know of no prohibition against accepting unsolicited donations from donors in such states who approach us with offers to donate.

International donations are gratefully accepted, but we cannot make any statements concerning tax treatment of donations received from outside the United States. U.S. laws alone swamp our small staff.

Please check the Project Gutenberg web pages for current donation methods and addresses. Donations are accepted in a number of other ways including checks, online payments and credit card donations. To donate, please visit: www.gutenberg.org/donate

Section 5. General Information About Project Gutenberg™ electronic works

Professor Michael S. Hart was the originator of the Project Gutenberg™ concept of a library of electronic works that could be freely shared with anyone. For forty years, he produced and distributed Project Gutenberg™ eBooks with only a loose network of volunteer support.

Project Gutenberg™ eBooks are often created from several printed editions, all of which are confirmed as not protected by copyright in the U.S. unless a copyright notice is included. Thus, we do not necessarily keep eBooks in compliance with any particular paper edition.

Most people start at our website which has the main PG search facility: www.gutenberg.org.

This website includes information about Project Gutenberg™, including how to make donations to the Project Gutenberg Literary Archive Foundation, how to help produce our new eBooks, and how to subscribe to our email newsletter to hear about new eBooks.